



# TURBO HD

## Full Time Color Series Turret Camera

### User Manual

#### User Manual

Thank you for purchasing our product. If there are any questions, or requests, do not hesitate to contact the dealer.

This manual applies to the models below:

Model
DS-2CE72DFT-F
DS-2CE72DFT-F28

This manual may contain technical incorrect places or printing errors, and the content is subject to change without notice. The updates will be added to the new version of this manual. We will readily improve or update the products or procedures described in the manual.

0100001091227

## Regulatory Information

### FCC Information

Please take attention that changes or modification not expressly approved by the party responsible for compliance could void the user's authority to operate the equipment.

**FCC compliance:** This equipment has been tested and found to comply with the limits for a Class A digital device, pursuant to part 15 of the FCC Rules. These limits are designed to provide reasonable protection against harmful interference when the equipment is operated in a commercial environment. This equipment generates, uses, and can radiate radio frequency energy and, if not installed and used in accordance with the instruction manual, may cause harmful interference to radio communications. Operation of this equipment in a residential area is likely to cause harmful interference in which case the user will be required to correct the interference at his own expense.

### FCC Conditions

This device complies with part 15 of the FCC Rules. Operation is subject to the following two conditions:

1. This device may not cause harmful interference.
2. This device must accept any interference received, including interference that may cause undesired operation.

### EU Conformity Statement



This product and - if applicable - the supplied accessories too are marked with "CE" and comply therefore with the applicable harmonized European

standards listed under the Low Voltage Directive 2014/35/EU, the EMC Directive 2014/30/EU, the RoHS Directive 2011/65/EU.



2012/19/EU (WEEE directive): Products marked with this symbol cannot be disposed of as unsorted municipal waste in the European Union. For proper recycling, return this product to your local supplier upon the purchase of equivalent new

equipment, or dispose of it at designated collection points. For more information see: [www.recyclethis.info](http://www.recyclethis.info).

2006/66/EC (battery directive): This product contains



a battery that cannot be disposed of as unsorted municipal waste in the European Union. See the product documentation for specific battery information. The battery is marked with this symbol, which may

include lettering to indicate cadmium (Cd), lead (Pb), or mercury (Hg). For proper recycling, return the battery to your supplier or to a designated collection point. For more information see: [www.recyclethis.info](http://www.recyclethis.info).

### Industry Canada ICES-003 Compliance

This device meets the CAN ICES-3 (A)/NMB-3(A) standards requirements.

### Warning

This is a class A product. In a domestic environment this product may cause radio interference in which case the user may be required to take adequate measures.



## Safety Instruction

These instructions are intended to ensure that user can use the product correctly to avoid danger or property loss.

The precaution measure is divided into “Warnings” and “Cautions”.

**Warnings:** Serious injury or death may occur if any of the warnings are neglected.

**Cautions:** Injury or equipment damage may occur if any of the cautions are neglected.

	
<b>Warnings</b> Follow these safeguards to prevent serious injury or death.	<b>Cautions</b> Follow these precautions to prevent potential injury or material damage.



### Warnings

- In the use of the device, you must be in strict compliance with the electrical safety regulations of the nation and region.
- Input voltage should meet both the SELV (Safety Extra Low Voltage) and the Limited Power Source with 12 VDC according to the IEC60950-1 standard. Refer to technical specifications for detailed information.
- Do not connect multiple devices to one power adapter to avoid over-heating or a fire hazard caused by overload.
- Make sure that the plug is firmly connected to the power socket.
- Make sure that the device is firmly fixed if wall mounting or ceiling mounting is adopted.
- If smoke, odor or noise rise from the device, turn off the power at once and unplug the power cord, and then contact the service center.
- Never attempt to disassemble the camera by unprofessional personal.



### Cautions

- Do not drop the camera or subject it to physical shock.
- Do not touch sensor modules with fingers.
- Do not place the camera in extremely hot, cold (the operating temperature shall be  $-40^{\circ}\text{C}$  to  $60^{\circ}\text{C}$ ), dusty or damp locations, and do not expose it to high electromagnetic radiation.
- If cleaning is necessary, use clean cloth with a bit of ethanol and wipe it gently.
- Do not aim the camera at the sun or extra bright places.
- The sensor may be burned out by a laser beam, so when any laser equipment is in using, make sure that the surface of sensor will not be exposed to the laser beam.
- Do not expose the device to high electromagnetic radiation or extremely hot, cold, dusty or damp environment.
- To avoid heat accumulation, good ventilation is required for the operating environment.

- Keep the camera away from liquid while in use for non-water-proof device.
- While in delivery, the camera shall be packed in its original packing, or packing of the same texture.

## Mark Description

Table 0-1 Mark Description

Mark	Description
---	DC Voltage

# 1 Introduction

## 1.1 Product Features

The main features are as follows:

- High performance CMOS sensor
- Full time color
- OSD menu with configurable parameters
- Auto white balance
- Internal synchronization
- Smart light mode
- 3-axis adjustment

## 1.2 Overview

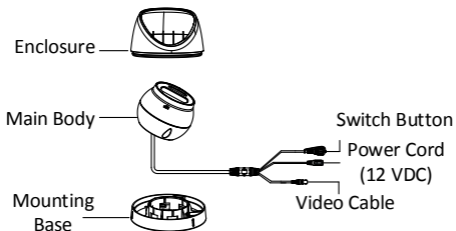

Figure 1-1 Overview of Type I Camera

### **Note:**

Press and hold the switch button for 5 seconds to switch the video output. Four kinds of video outputs are available: TVI, AHD, CVI, and CVBS.

## 2 Installation

### Before you start:

- Make sure that the device in the package is in good condition and all the assembly parts are included.
- Make sure that all the related equipment is power-off during the installation.
- Check the specification of the products for the installation environment.
- Check whether the power supply is matched with your required output to avoid damage.
- Make sure the wall is strong enough to withstand three times the weight of the camera, and the mount.
- If the wall is cement, insert expansion screws before installing the camera. If the wall is wooden, use self-tapping screw to secure the camera.
- If the product does not function properly, contact your dealer or the nearest service center. Do NOT disassemble the camera for repair or maintenance by yourself.

### 2.1 Ceiling/Wall Mounting without Junction Box

#### Steps:

1. Disassemble the camera.
  - 1). Rotate the camera to align the notch to one of the marks.
  - 2). Pry the mounting base to remove the mounting base with the camera body with a flat object, e.g., a coin.

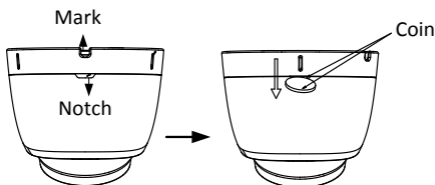

2. Paste the drill template (supplied) to the place where you want to install the camera.
3. Drill the screw holes, and the cable hole (optional) in the ceiling/wall according to the drill template.

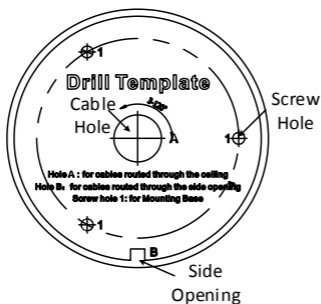

Figure 2-1 Drill Template

#### Note:

Drill the cable hole, when adopting the ceiling outlet to route the cable

4. Attach the mounting base to the ceiling/wall, and secure them with supplied screws

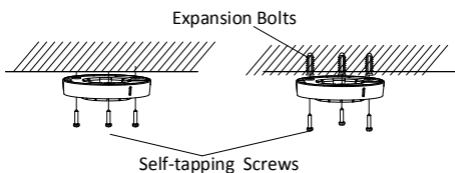

Figure 2-2 Attach the Mounting Base to the Ceiling

**Note:**

- The supplied screw package contains self-tapping screws, and expansion bolts.
  - For cement wall/ceiling, expansion bolts are required to fix the camera. For wooden wall/ceiling, self-tapping screws are required.
5. Route the cables through the cable hole, or the side opening.
  6. Align the camera with the mounting base, and secure the camera on the mounting base.

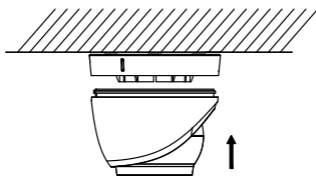
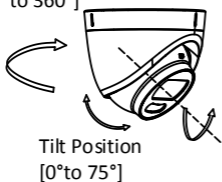

Figure 2-3 Secure the Camera with Mounting Base

7. Connect the corresponding cables, such as power cord, and video cable.
8. Power on the camera to check whether the image on the monitor is gotten from the optimum angle. If not, adjust the camera according to the figure below to get an optimum angle.

Pan Position  
[0° to 360°]



Rotation Position  
[0° to 360°]

Tilt Position  
[0° to 75°]

Figure 2-4 3-axis Adjustment

- 1). Hold the camera body and rotate the enclosure to adjust the pan position [0° to 360°].
- 2). Move the camera body up and down to adjust the tilt position [0° to 75°].
- 3). Rotate the camera body to adjust the rotation position [0° to 360°].

## 2.2 Ceiling/Wall Mounting with Junction Box

**Before you start:**

You need to purchase a junction box separately.

**Steps:**

1. Paste the drill template on the ceiling/wall.
2. Drill screw holes and the cable hole (optional) in the ceiling/wall according to the holes of the drill template.



Figure 2-5 Drill Template of the Junction Box

**Note:**

Drill the cable hole, when adopting the ceiling outlet to route the cable.

3. Take apart the junction box, and align the screw holes of the turret camera's mounting base with those on junction box's cover.
4. Fix the mounting base on junction box's cover by supplied screws.

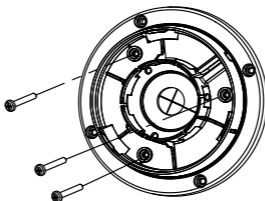

Figure 2-6 Install Turret Camera's Mounting Base

5. Secure the junction box's body with supplied screws on the ceiling/wall.

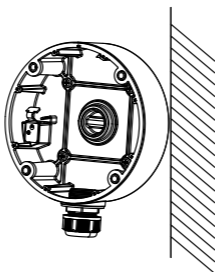

Figure 2-7 Install the Junction Box' Camera Body on Ceiling/Wall

6. Combine the junction box's cover with the junction box's body.
7. Repeat steps 5 to 8 of 2.1.1 *Ceiling/Wall Mounting without Junction Box* to install the camera to the junction box.

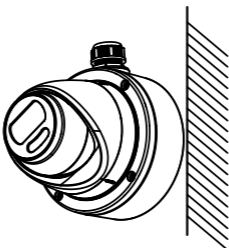



Figure 2-8 Fix the Camera to the Junction Box

## 3 Menu Description

### Purpose:

Call the menu by clicking button  on the PTZ Control interface, or call the preset No.95.

### Steps:

1. Connect the camera with the TVI DVR, and the monitor, shown as the figure 3-1.

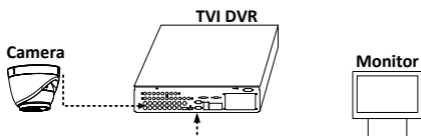



Figure 3-1 Connection

2. Power on the analog camera, TVI DVR, and the monitor to view the image on the monitor.
3. Click PTZ Control to enter the PTZ Control interface.
4. Call the camera menu by clicking  button, or call the preset No. 95.

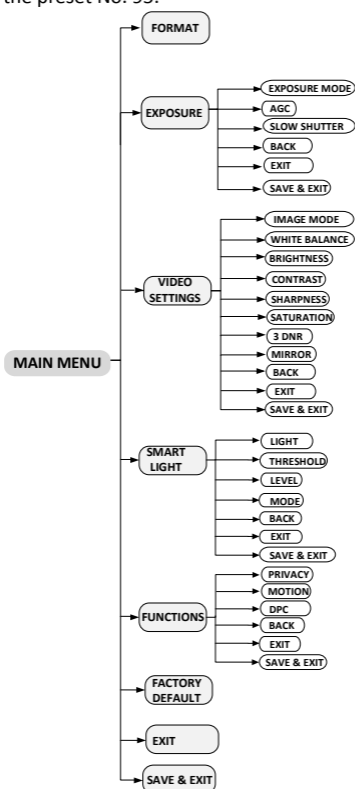

Figure 3-2 Main Menu Overview

5. Click the direction arrow to control the camera.
  - 1). Click up/down direction button to select the item.
  - 2). Click Iris + to confirm the selection.
  - 3). Click left/right direction button to adjust the value of the selected item.



### 3.1 FORMAT

You can set the video format as 2MP@25fps, or 2MP@30fps.

### 3.2 EXPOSURE

**EXPOSURE** describes the brightness-related parameters, which can be adjusted by **EXPOSURE MODE**, **AGC**, and **SLOW SHUTTER**.

EXPOSURE	
EXPOSURE MODE	◀ GLOBAL ▶
AGC	◀ MEDIUM ▶
SLOW SHUTTER	◀ OFF ▶
BACK	↵
EXIT	↵
SAVE & EXIT	↵

Figure 3-3 EXPOSURE

#### EXPOSURE MODE

You can set the **EXPOSURE MODE** as **GLOBAL**, **BLC**, or **WDR**.

- **GLOBAL**

**GLOBAL** refers to the normal exposure mode which adjusts lighting distribution, variations, and non-standard processing.

- **BLC (Backlight Compensation)**

**BLC** (Backlight Compensation) compensates light to the object in the front to make it clear, but this may cause the over-exposure of the background where the light is strong.

- **WDR (Wide Dynamic Range)**

The wide dynamic range helps the camera provide clear images even under backlight circumstances. **WDR** balances the brightness level of the whole image and provides clear images with details.

#### **AGC (Auto Gain Control)**

It optimizes the clarity of the image in poor light conditions. The **AGC** level can be set as **HIGH**, **MEDIUM**, or **LOW**. Select **OFF** to disable the **AGC** function.

**Note:**

The noise will be amplified when the **AGC** is on.

#### **SLOW SHUTTER**

**SLOW SHUTTER** increases the exposure time on a single frame, which makes a camera more sensitive to the light so it can produce images even in low lux conditions.

You can set the **SLOW SHUTTER** function as OFF, x2, x4, x6, x8, x10, x12, x14, or x16 according to the different light conditions.

### 3.3 VIDEO SETTINGS

Move the cursor to **VIDEO SETTINGS** and click Iris+ to enter the sub-menu. **IMAGE MODE**, **WHITE BALANCE**, **BRIGHTNESS**, **CONTRAST**, **SHARPNESS**, **SATURATION**, **3 DNR**, and **MIRROR** are adjustable.

VIDEO SETTINGS	
IMAGE MODE	◀ STD ▶
WHITE BALANCE	↵
BRIGHTNESS	◀ 5 ▶
CONTRAST	◀ 5 ▶
SHARPNESS	◀ 5 ▶
SATURATION	◀ 5 ▶
3DNR	◀ 5 ▶
MIRROR	◀ OFF ▶
BACK	↵
EXIT	↵
SAVE & EXIT	↵

Figure 3-4 VIDEO SETTINGS

## IMAGE MODE

**IMAGE MODE** is used to adjust the image saturation, and you can set it to **STD** (Standard) or **HIGH-SAT** (High Saturation).

## WHITE BALANCE

White balance, the white rendition function of the camera, is to adjust the color temperature according to the environment. It can remove unrealistic color casts in the image. You can set **WHITE BALANCE** mode as **AUTO**, or **MANUAL**.

### ● AUTO

Under the **AUTO** mode, white balance is being adjusted automatically according to the color temperature of the scene illumination.

### ● MANUAL

You can set the **R-GAIN/B-GAIN** value from 1 to 255 to adjust the shades of red/blue color of the image.

WHITE BALANCE	
MODE	◀ MANUAL ▶
R-GAIN	◀ 5 ▶
B-GAIN	◀ 5 ▶
BACK	↵
EXIT	↵
SAVE & EXIT	↵

Figure 3-5 MANUAL MODE

## BRIGHTNESS

Brightness refers to the brightness of the image. You can set the **BRIGHTNESS** value from 1 to 9 to darken or brighten the image. The greater the value is, the brighter the image is.

## CONTRAST

This feature enhances the difference in color and light between parts of an image. You can set the **CONTRAST** value from 1 to 9.

## SHARPNESS

Sharpness determines the amount of detail an imaging system can reproduce. You can set the **SHARPNESS** value from 1 to 9.

## SATURATION

Adjust this feature to change the saturation of the color. The value ranges from 1 to 9.

## 3 DNR (Digital Noise Reduction)

The **3 DNR** function can decrease the noise effect, especially when capturing moving images in poor light

conditions, and delivering more accurate and sharper image. You can set the **3 DNR** value from 1 to 9.

## MIRROR

**OFF, H, V, and HV** are selectable for mirror.

**OFF:** The mirror function is disabled.

**H:** The image flips 180° horizontally.

**V:** The image flips 180° vertically.

**HV:** The image flips 180° both horizontally and vertically.

## 3.4 SMART LIGHT

**SMART LIGHT** is used to control the integrated white light and avoid overexposure when the light is on. You can set the light as **AUTO** or **OFF**.

SMART LIGHT	
LIGHT	◀ AUTO ▶
THRESHOLD	◀ 2 ▶
LEVEL	◀ 5 ▶
MODE	MODE1
BACK	⌊
EXIT	⌊
SAVE & EXIT	⌊

Figure 3-6 SMART LIGHT

### AUTO

Under the **AUTO** mode, the white light turns on automatically as the environment becomes dark.

The **THRESHOLD** is the environmental light level at which the white light turns on. The greater the value is, the darker the environment is when the light is activated.

The value of **LEVEL** controls the brightness of the white light. The greater the value is, the brighter the light is.

### OFF

The white light is always off except when alarm is set and triggered.

### MODE

You can set the **MODE** as **MODE1** to get a brighter image in low light conditions.

## 3.5 FUNCTIONS

In the **FUNCTIONS** sub-menu, you can set the privacy mask, the motion detection, and DPC of the camera.

### PRIVACY

The privacy mask allows you to cover certain areas which you don't want to be viewed, or recorded. Up to 4 privacy areas are configurable.

PRIVACY	
MODE	◀ ON ▶
AREA 0	⌊
AREA 1	⌊
AREA 2	⌊
AREA 3	⌊
COLOR	◀ RED ▶
TRANSPARENCY	◀ OFF ▶
BACK	⌊
EXIT	⌊
SAVE & EXIT	⌊

Figure 3-7 PRIVACY

Select a **PRIVACY** area. Set the **MODE** as **ON**. Click up/down/left/right button to define the position, and the size of the area.

### MOTION

In the user-defined motion detection surveillance area, the moving object can be detected and the alarm will be triggered. Up to 4 motion detection areas can be configured.

MOTION	
MODE	◀ OFF ▶
AREA 0	⌞
AREA 1	⌞
AREA 2	⌞
AREA 3	⌞
SENSITIVITY	◀ 50 ▶
COLOR	◀ RED ▶
TRANSPARENCY	◀ OFF ▶
BACK	⌞
EXIT	⌞
SAVE & EXIT	⌞

Figure 3-8 MOTION

Select a **MOTION** area. Set the **MODE** as **ON**. Click the up/down/left/right button to define the position, and the size of the area. Set the **SENSITIVITY** from 0 to 100.

### DPC (Defective Pixel Correction)

Defective pixels are pixels in a CMOS image sensor, which fail to sense light levels correctly.

This series of camera supports defective pixel correction. You can set the **DPC** as **ON** or **OFF**.

### 3.6 FACTORY DEFAULT

Reset all the settings to the factory default.

### 3.7 SAVE & EXIT

Move the cursor to **SAVE & EXIT** and click **Iris+** to save the setting, and exit the menu.