



FD9189-H, FD9189-HM, FD9189-HT

FD9389-HV, FD9389-EHV, FD9389-HMV,
FD9389-EHMV, FD9389-HTV,
FD9389-EHTV

Fixed Dome
Network Camera

User's Manual

5MP • IP66 (outdoor) • IK10 • Day & Night • Smart Motion Detection (H/T) •
Remote Focus (T) • WDR Pro II • Smart Stream III • SNV II • 30M Smart IR • Shock Detection

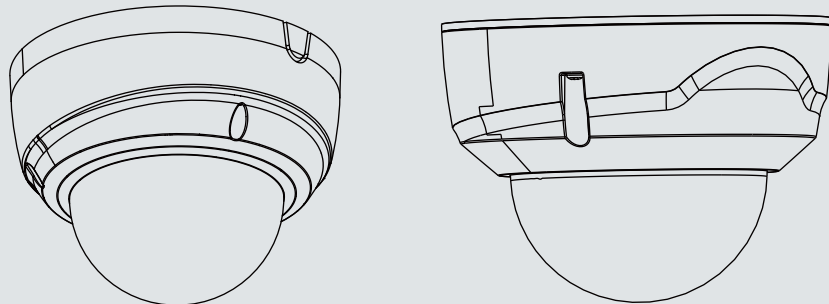

Rev. 1.0

Table of Contents

Overview	3
Revision History	4
Read Before Use	4
Package Contents	5
Symbols and Statements in this Document	5
Physical Description	6
Hardware Installation (FD9189)	12
Software Installation	16
Hardware Installation (FD9389)	22
Software Installation	29
Network Deployment	37
Ready to Use	38
Accessing the Network Camera	41
Using Web Browsers	41
Using RTSP Players	44
Using 3GPP-compatible Mobile Devices	45
Using VIVOTEK Recording Software	46
Main Page	47
Client Settings	52
Configuration	57
System > General settings	58
System > Homepage layout	60
System > Logs	63
System > Parameters	65
System > Maintenance	66
Media > Image	70
Media > Video	83
Media > Video	84
Media > Video	85
Media > Audio	94
Network > General settings	95
Network > Streaming protocols	102
Network > SNMP (Simple Network Management Protocol)	111
Network > FTP	112
Security > User accounts	113
Security > HTTPS (Hypertext Transfer Protocol over SSL)	115
Security > Access List	122
PTZ > PTZ settings	128
Event > Event settings	132
Applications > Motion detection	146
Applications > Smart VCA	147
Applications > Tampering detection	148
Applications > Audio detection	149
Applications > Shock detection	151

Applications > Package management - a.k.a., VADP (VIVOTEK Application Development Platform) ...	152
Recording > Recording settings	155
Local storage > SD card management.....	160
Local storage > Content management.....	161
Appendix	164
URL Commands for the Network Camera.....	164
Technology License Notice.....	415
Electromagnetic Compatibility (EMC).....	416

Overview

The 9189 and 9389 series is a camera line to come embedded with the Smart Motion Detection feature (-H, -EH, -HT, -EHT models).* The Smart Motion detection, with Human detection and tunable time filter, can eliminate the defects of traditional motion detection and facilitate the configuration at a surveillance site.

To learn more about this feature, download its User Guide in:

http://download.vivotek.com/downloadfile/solutions/vadp/smart-motion-detection-manual_en.pdf

A key feature in the Smart Motion detection is the Human detection. Based on a human silhouette database and the rapid responses via an artificial neural network technology, the Smart engine instantly recognizes human appearances in a video surveillance area. Since humans are the objects of interest in the majority of video surveillance, the Human detection feature enables users to quickly configure his installation.

With Human detection, light changes or swaying vegetation, vehicles passing by, or animal activities in the scene are not taken as event triggers. Only human activities will trigger an event. This helps reduce false alarms and the time and efforts for a camera configuration.

The 9389 series is an outdoor network camera capable of 2560 x 1920 resolution at 30 fps. With the most updated VIVOTEK SNV and WDR Pro technology, the 9389 series is capable of capturing the highest quality images in both low light and high contrast environments.

The 9189 and 9389 series also offers the best in night time surveillance technology. By adopting Smart IR II technology from VIVOTEK speed domes, the IR illuminators now align with the remote focus lens' focus angle to provide the best IR image quality at any lens setting. This feature optimizes IR intensity, reduces IR hotspots, and increases the IR effective range up to 30 meters.

* The FD9389-HM and -EHM models come with standard motion detection feature.

Revision History

- Rev. 1.0: Initial release.

Read Before Use

The use of surveillance devices may be prohibited by law in your country. The Network Camera is not only a high-performance web-ready camera but can also be part of a flexible surveillance system. It is the user's responsibility to ensure that the operation of such devices is legal before installing this unit for its intended use.

It is important to first verify that all contents received are complete according to the Package Contents listed below. Take note of the warnings in the Quick Installation Guide before the Network Camera is installed; then carefully read and follow the instructions in the Installation chapter to avoid damage due to faulty assembly and installation. This also ensures the product is used properly as intended.

The Network Camera is a network device and its use should be straightforward for those who have basic networking knowledge. It is designed for various applications including video sharing, general security/surveillance, etc. The Configuration chapter suggests ways to best utilize the Network Camera and ensure proper operations. For creative and professional developers, the URL Commands of the Network Camera section serves as a helpful reference to customizing existing homepages or integrating with the current web server.

Package Contents

- FD9189 or FD9389
- Desiccant bag, screws.
- Sunshield and screws.
- Quick Installation Guide.



WARNING:

1. IR lights emit from this product.
2. Use live view to verify if the IR lights are on in the night mode.

Symbols and Statements in this Document



INFORMATION: provides important messages or advices that might help prevent inconvenient or problem situations.



NOTE: Notices provide guidance or advices that are related to the functional integrity of the machine.



Tips: Tips are useful information that helps enhance or facilitate an installation, function, or process.



WARNING: or IMPORTANT: These statements indicate situations that can be dangerous or hazardous to the machine or you.



Electrical Hazard: This statement appears when high voltage electrical hazards might occur to an operator.



IMPORTANT:

1. The camera is only to be connected to PoE networks without routing to outside plants.
2. For PoE connection, use only UL listed I.T.E. with PoE output.

1. La caméra ne doit être raccordée qu'à des réseaux PoE, sans routage vers des installations extérieures.
2. Pour les raccordements PoE, utilisez uniquement un équipement de TI homologué UL, avec une sortie PoE.

Use the camera only with a DC power supply that is UL listed, and limited power source (LPS) certified. The power supply should bear the UL listed and LPS marks. The power supply should also meet any safety and compliance requirements for the country of use.

n'utilisez la caméra qu'avec un bloc d'alimentation CC homologué UL, ainsi qu'avec une alimentation limitée (LPS) certifiée. Le bloc d'alimentation doit porter les indications d'homologation UL et LPS. Il doit également répondre aux exigences en matière de sécurité et de conformité relatives au pays d'utilisation.

Physical Description

FD9189 Outer View

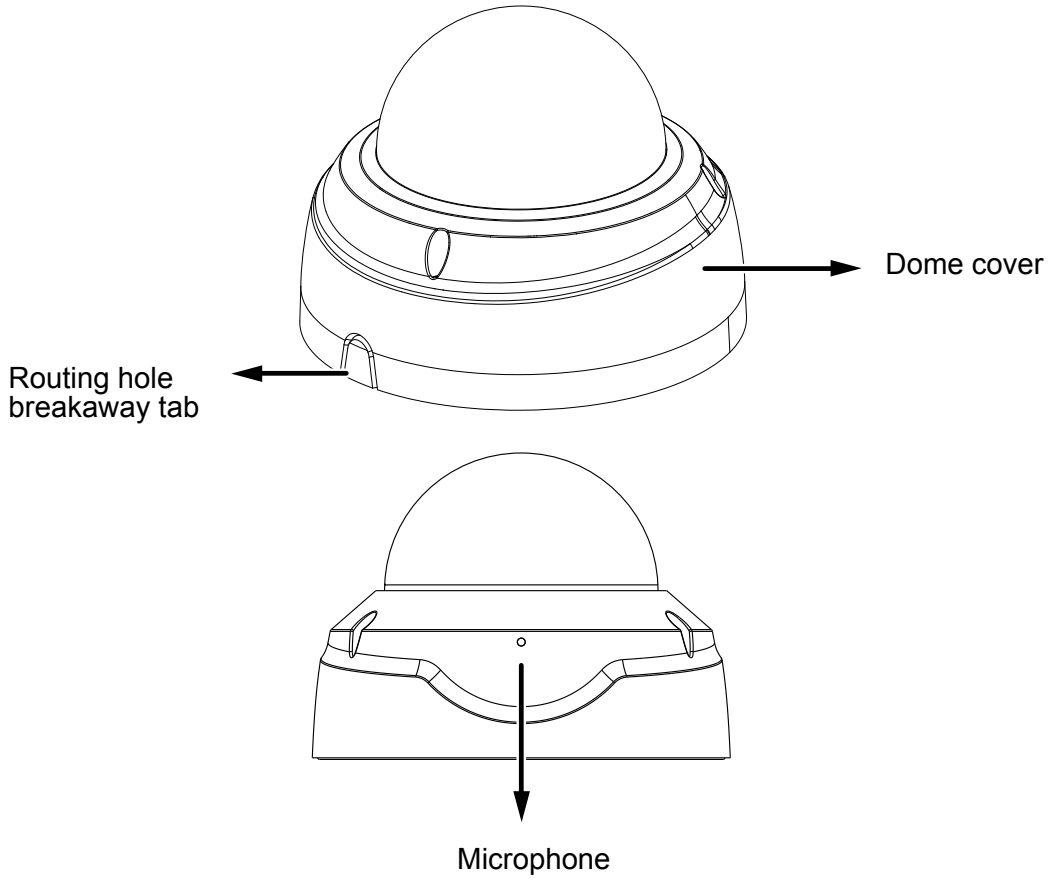

FD0189 Inner View

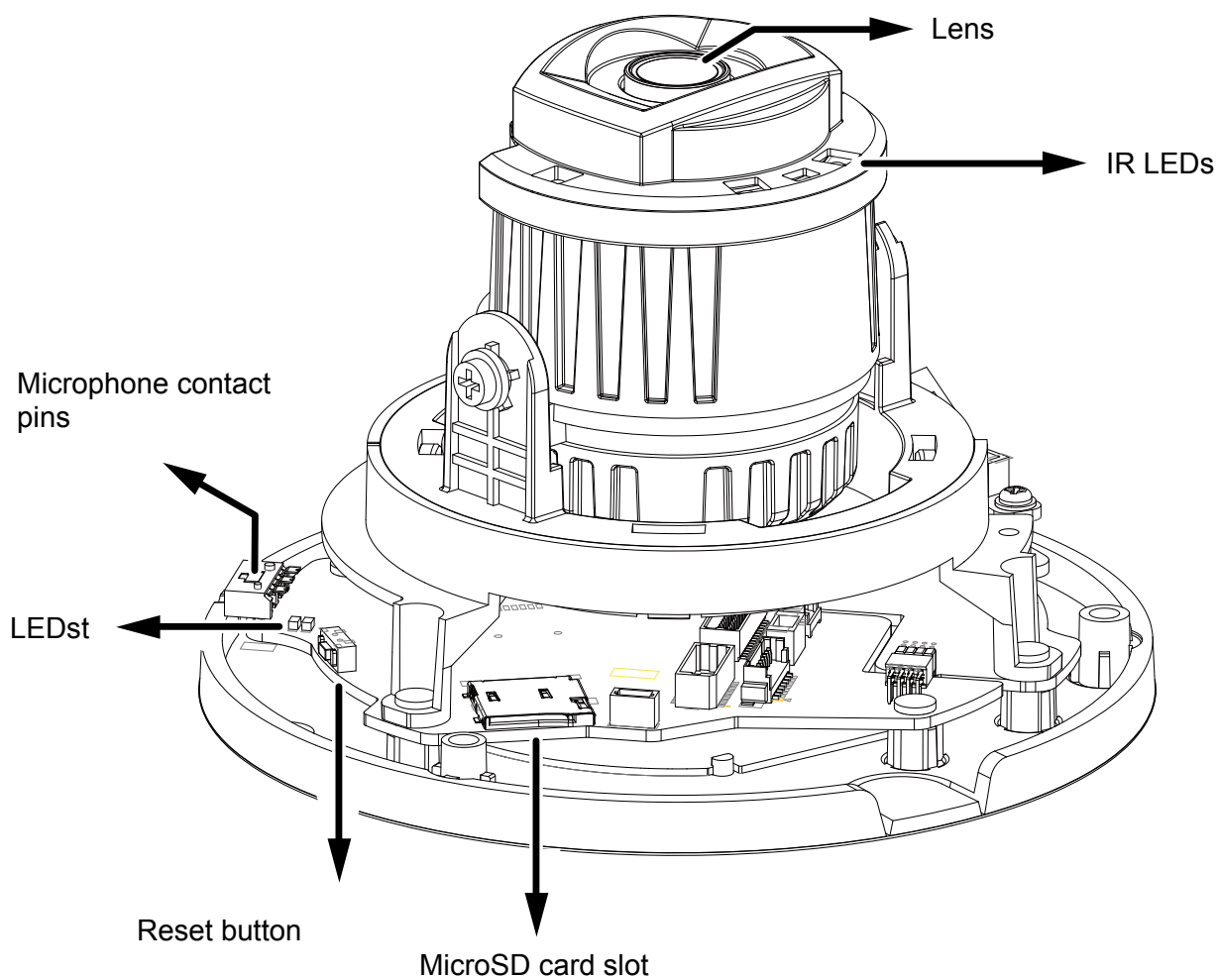
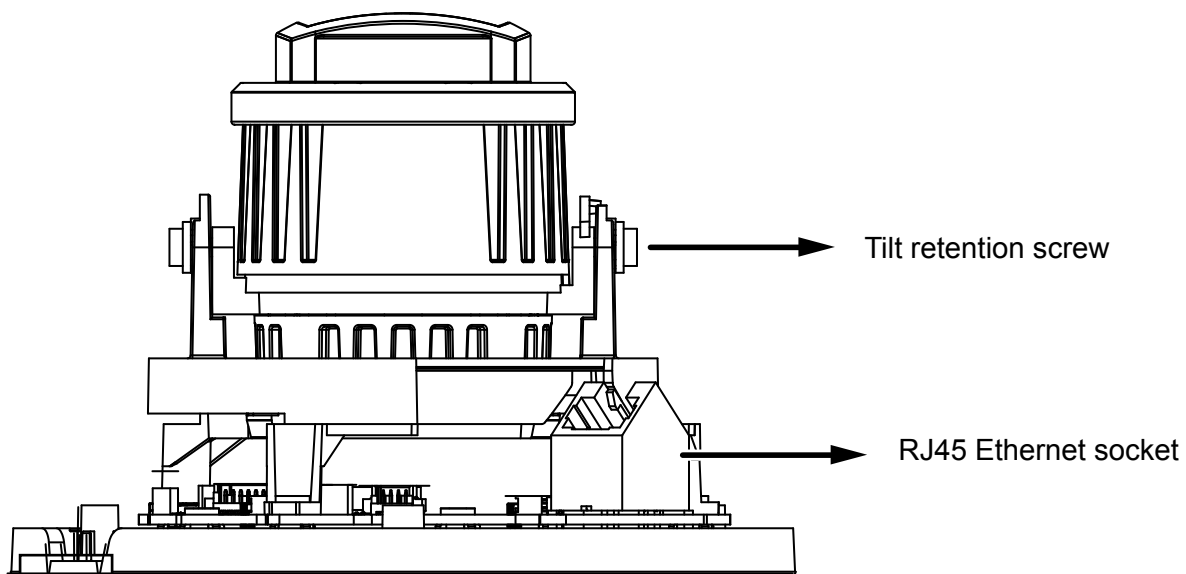

FD9389 Outer View

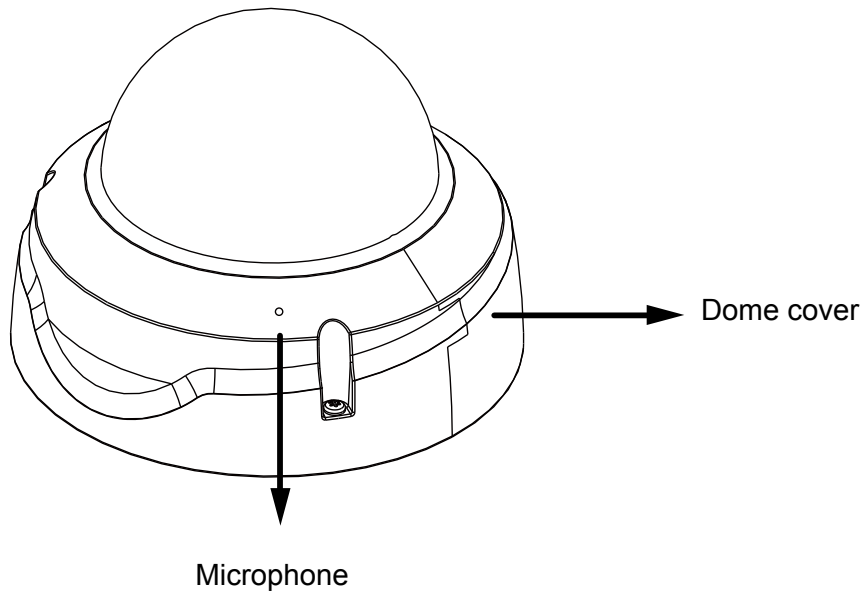

FD9389 Inner View

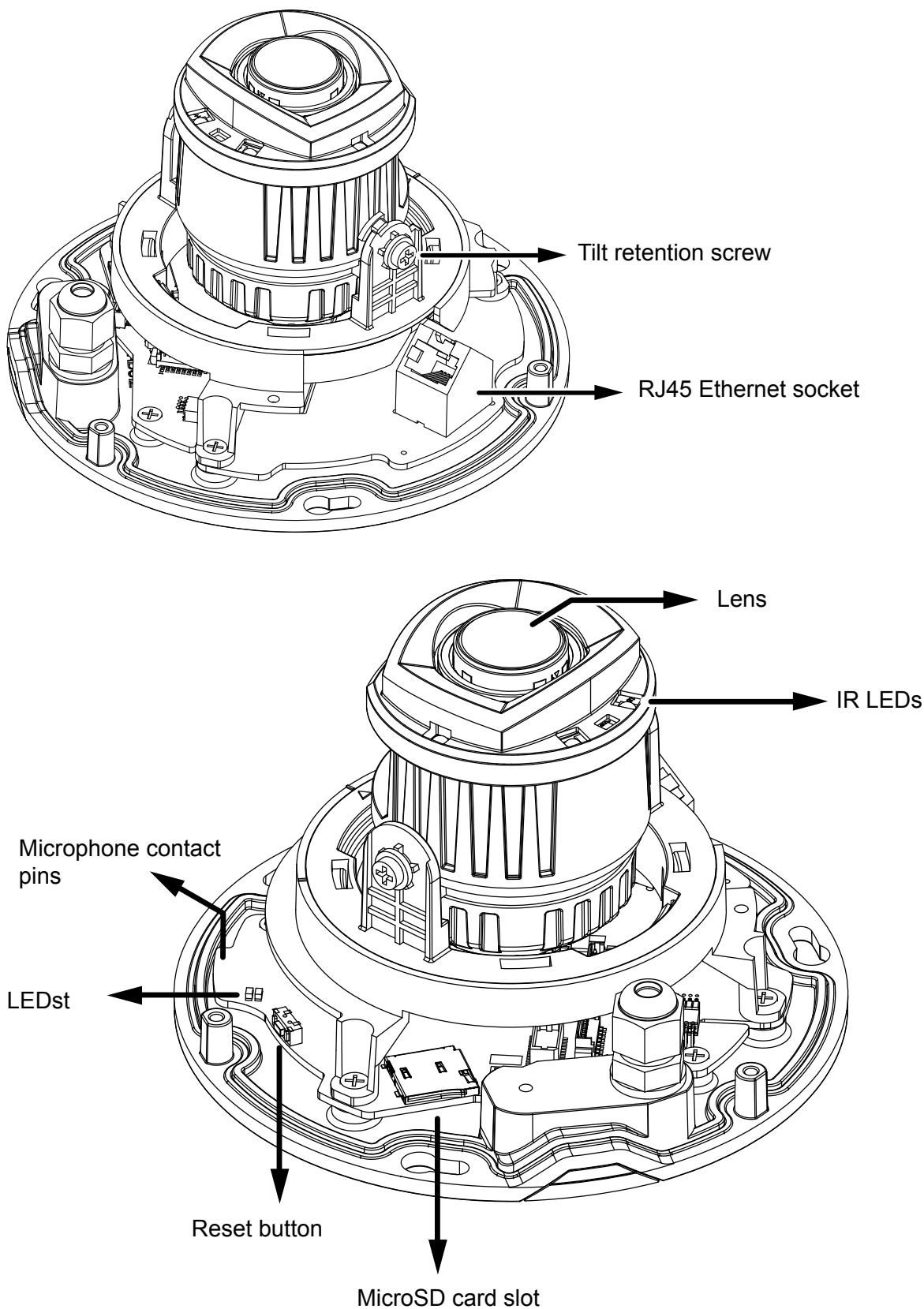

An example of the "-M" model (Manual Focus) is shown here. For models that come with motorized lens, you do not need to manually adjust zoom and focus.

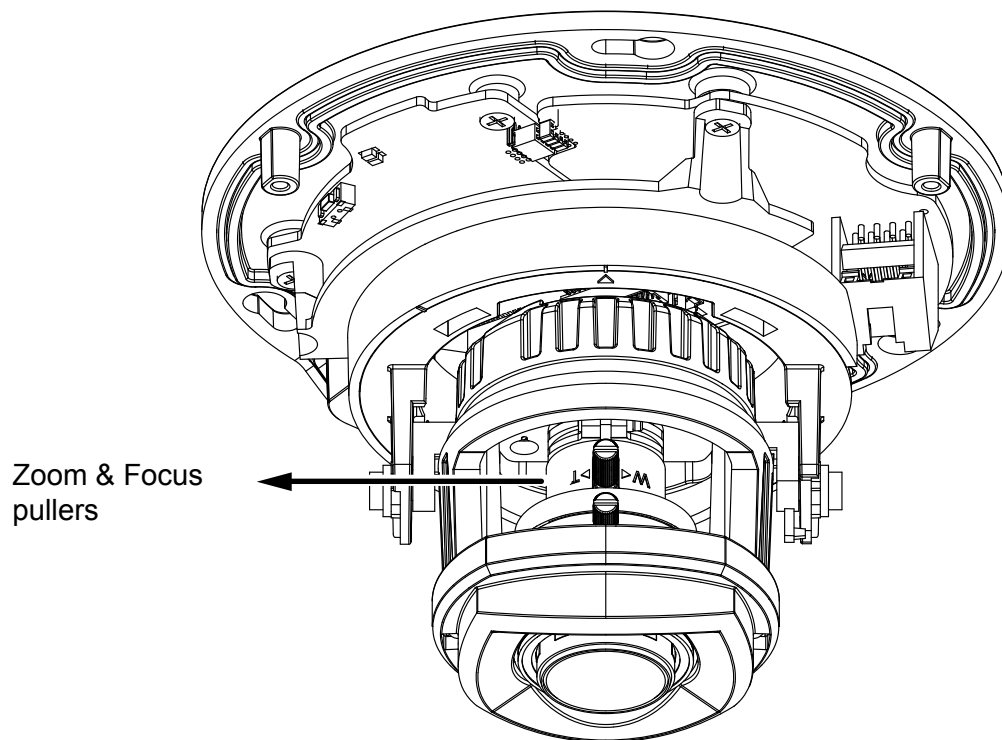
**IMPORTANT:**

Many copper coated aluminum (CCA) and other non-standard conductors cabling products are masqueraded as CAT5E or CAT6 cables. Please avoid using these CCA products especially when cascading PoE cameras. It is a must to use Ethernet cables compliant with the 3P/ETL standard.

NOTE:

Some of the suffix syntax used in model naming are listed below:

E	w/ heater for extreme weather
Fx	Focal length w/ number
T	w/ Remote focus lens
R	w/ PoE repeater
H	w/ High Dynamic Range functionality
M	Manual focus lens

IMPORTANT:

802.3af or 802.3at

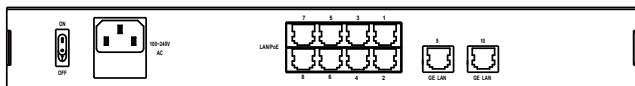

The E model camera comes with an embedded heater and requires an 802.3at PoE switch.

Max. Power Consumption (via PoE)			
Model	Watts	Voltage	Amp
FD9189-HT	10.45	37 ~ 57	0.28 ~ 0.18
FD9189-HM	8.3	37 ~ 57	0.22 ~ 0.15
FD9189-H	8.7	37 ~ 57	0.24 ~ 0.15

Max. Power Consumption (via PoE)			
Model	Watts	Voltage	Amp
FD9389-EHTV	23.55	42.5 ~ 57	0.55 ~ 0.41
FD9389-EHMTV	21.4	42.5 ~ 57	0.50 ~ 0.38
FD9389-EHV	21.8	42.5 ~ 57	0.51 ~ 0.38
FD9389-HTV	10.45	37 ~ 57	0.28 ~ 0.18
FD9389-HTV (w/o cable)			
FD9389-HMTV	8.3	37 ~ 57	0.22 ~ 0.15
FD9389-HMTV (w/o cable)			
FD9389-HV	8.7	37 ~ 57	0.24 ~ 0.15
FD9389-HV(w/o cable)			

Hardware Installation (FD9189)

IMPORTANT:

If you plan to use the Human Detection feature, make sure you measure the installation height of your camera. The height information is important for the accuracy of the video analytics results. Some of the other perspective information are automatically collected by the onboard S-sensor. The height information enables the horizontal and vertical keystone corrections of the field of view. Measure the distance between camera lens and the ground.

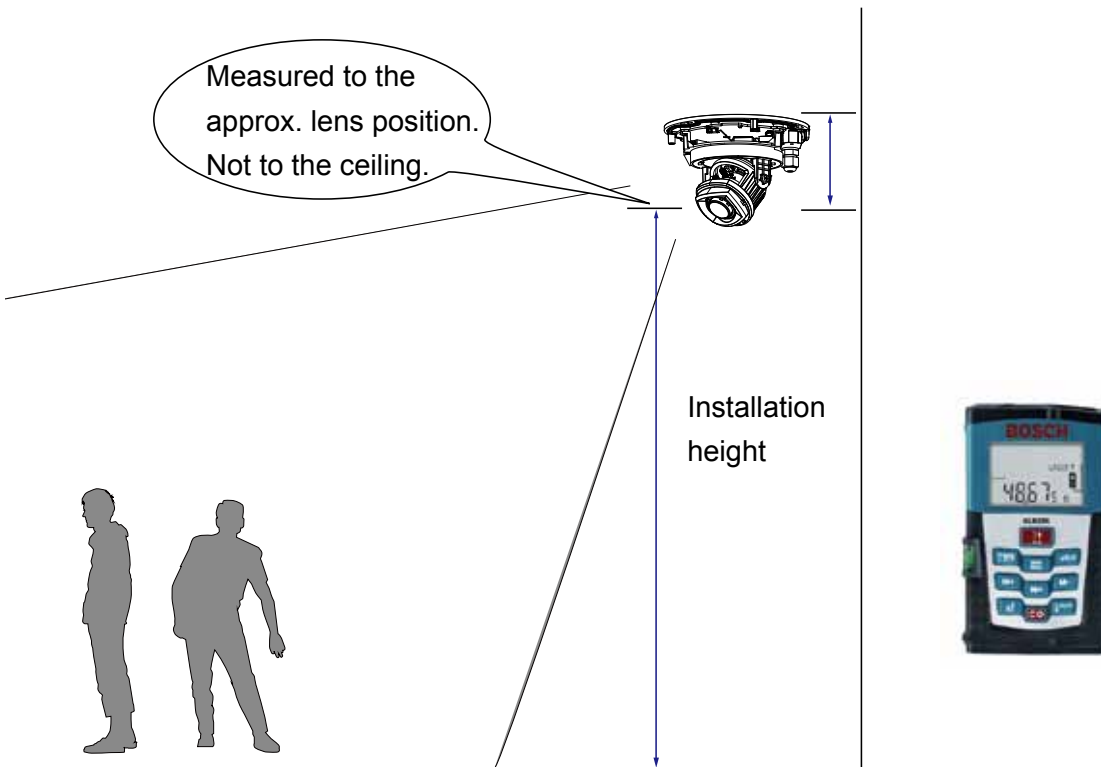

1. Jot down the camera's MAC address for later reference.

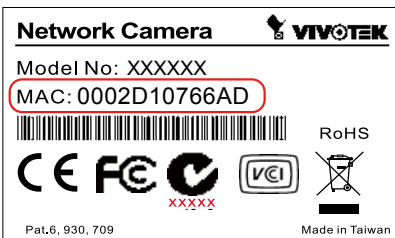

2. Remove the dome cover by loosening 4 T10 screws.

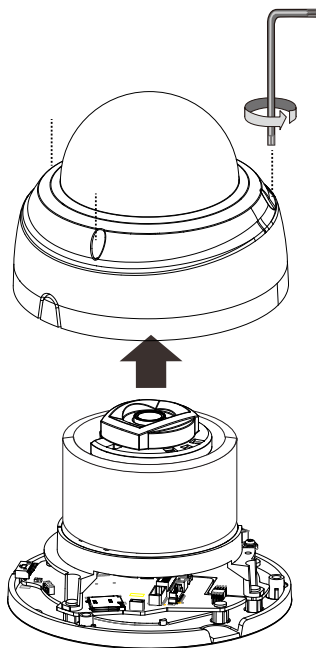

3. Install an MicroSD card if onboard storage is preferred. Remove the foam pad around the lens module.

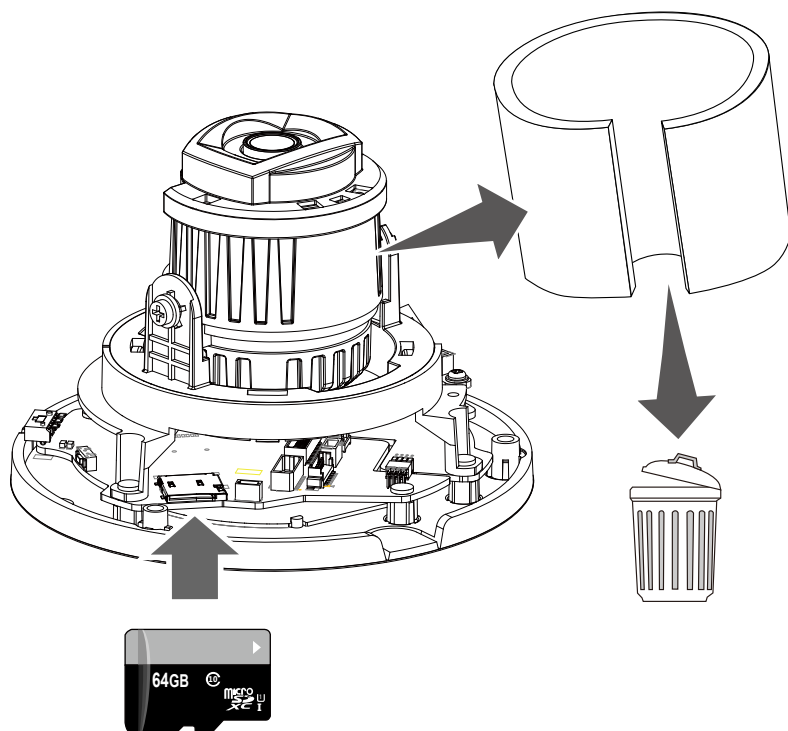

- Remove the breakaway tab at the bottom or on the side of the dome cover depending on how you route your Ethernet cable.

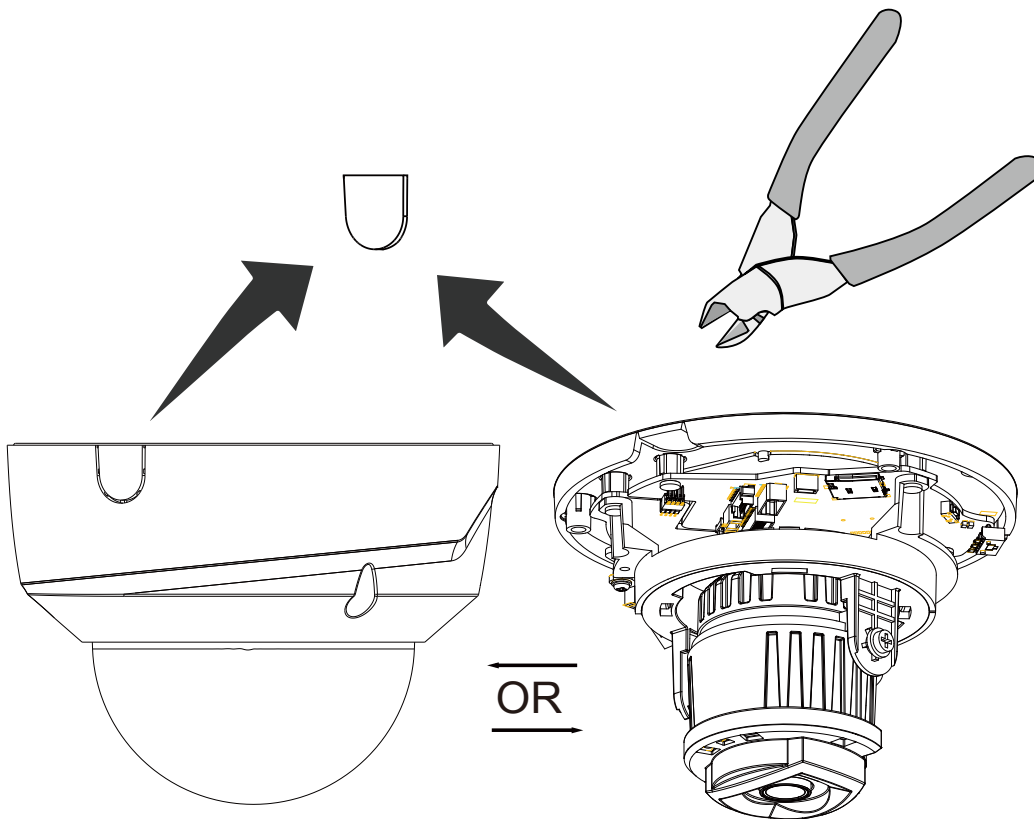

- Drill holes for mounting screws and a cabling hole if applicable. Pull a CAT5e Ethernet cable through the hole.

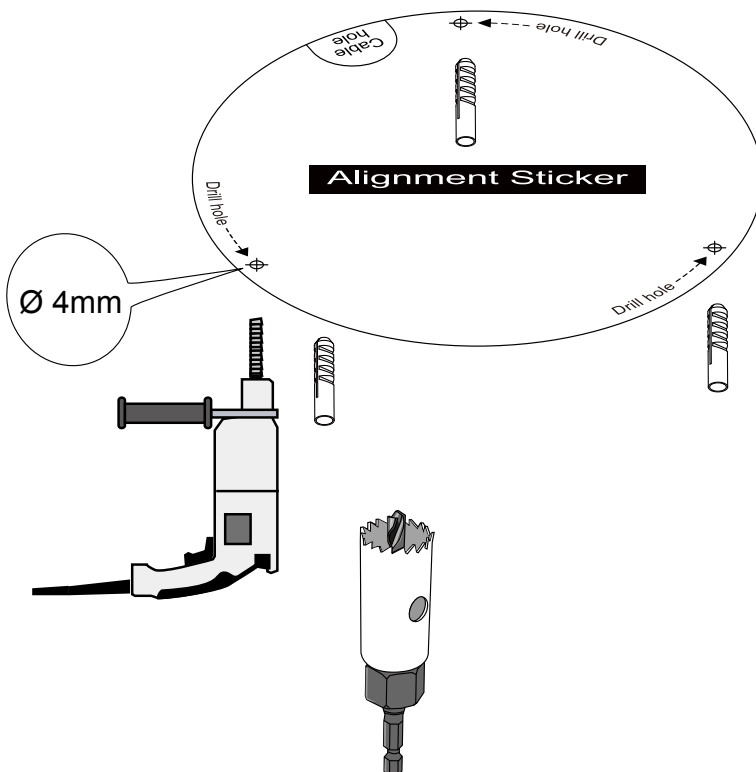

6. Secure the camera to wall or ceiling using the included screws.

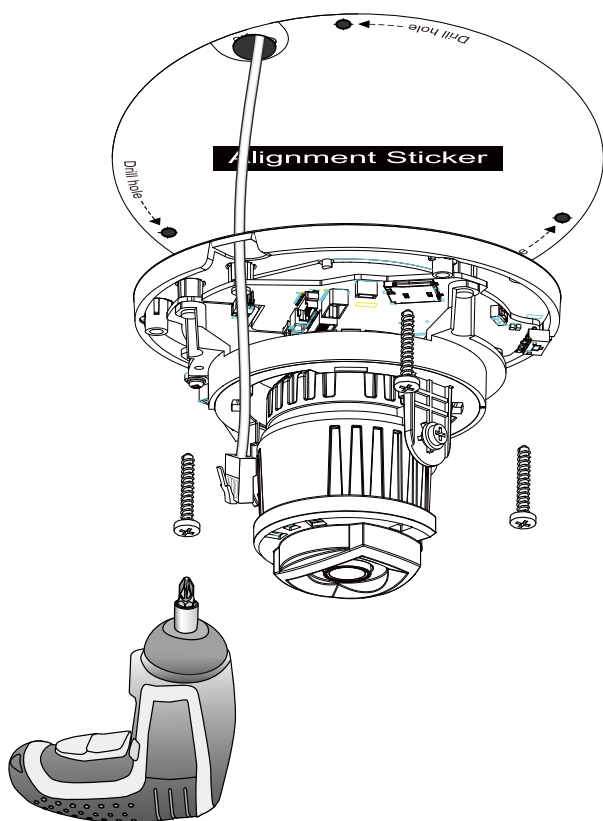

7. Connect the Ethernet cable to the RJ45 port.

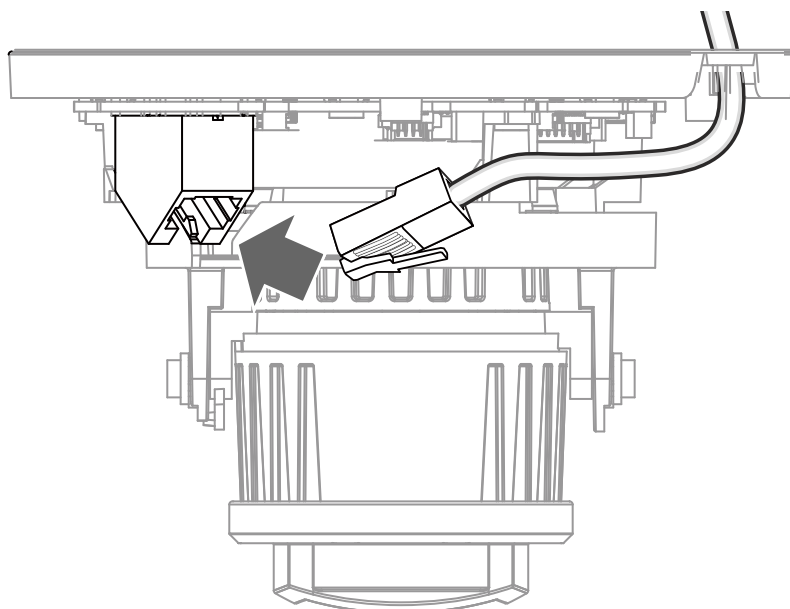

- Please visit VIVOTEK’s website to Install the "Shepherd" software utility. The program will search for VIVOTEK Video Receivers, Video Servers or Network Cameras on the same LAN.

Double-click on the camera’s MAC address to open a web console with the camera.



Software Installation

- Install the **Shepherd** utility, which helps you locate and configure your Network Camera in the local network. If your camera comes without the CD, go to VIVOTEK’s website, and locate the utility in the Downloads > Software page.



9-1. Run the Shepherd utility.

9-2. The program will conduct an analysis of your network environment.

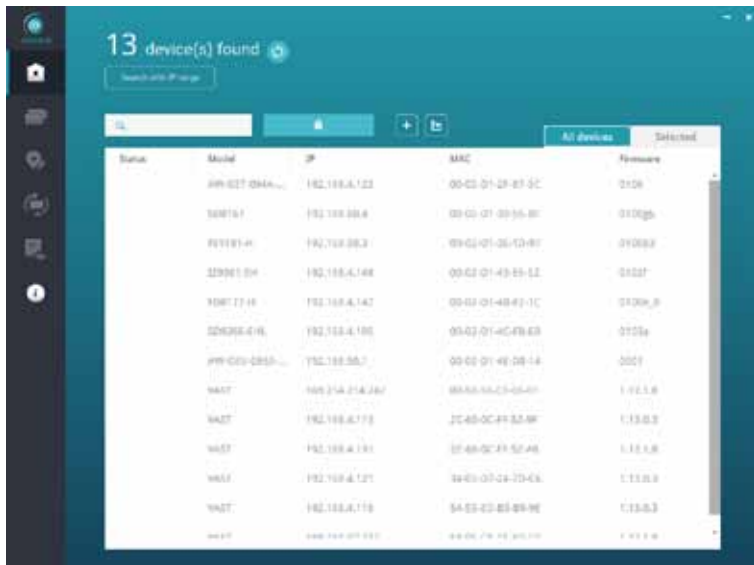

9-3. The program will search for all VIVOTEK network devices on the same LAN.

9-4. After a brief search, the installer window will prompt. Click on the MAC and model name that matches the one printed on the product label. You can then double-click on the address to open a management session with the Network Camera.

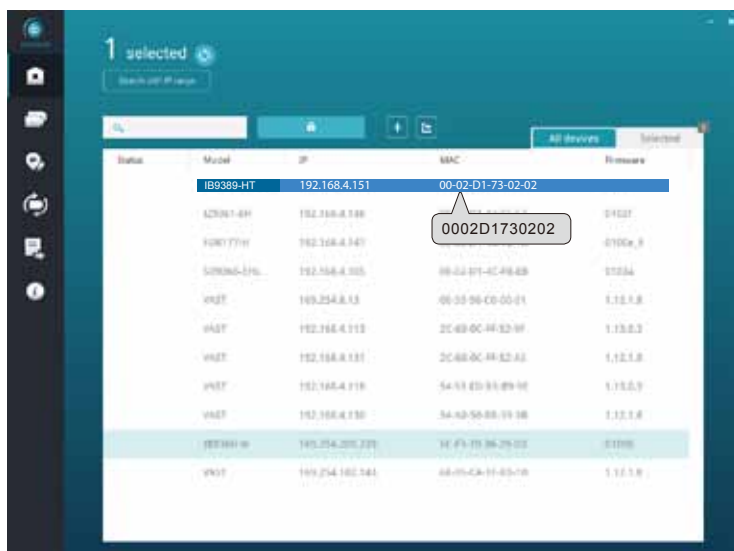

Forceful Password Configuration

10. The first time you log in to the camera, the firmware will prompt for a password configuration for security concerns.

10-1. Since your camera is used for the first time, there is no password. Enter “root” as the user name, and nothing for the password.



10-2. Enter the combination of alphabetic and numeric characters to fulfill the password strength requirement. The default name for the camera administrator is “root”, and can not be changed.

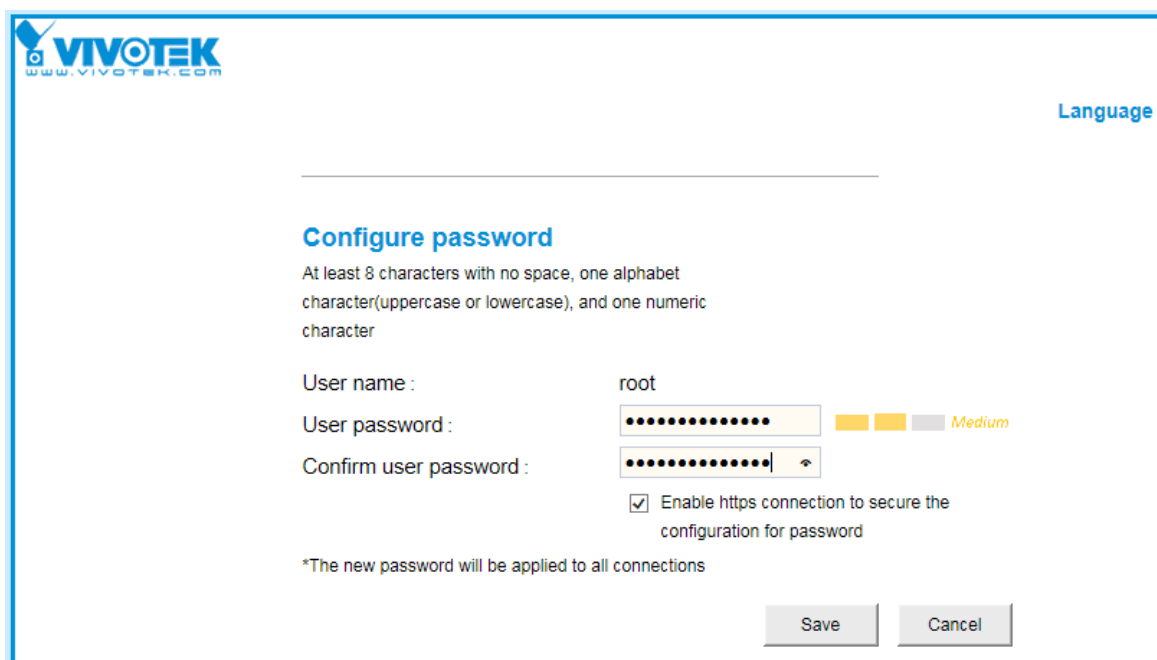

Some, but not all special ASCII characters are supported: !, \$, %, -, ., @, ^, _, and ~. You can use them in the password combination.

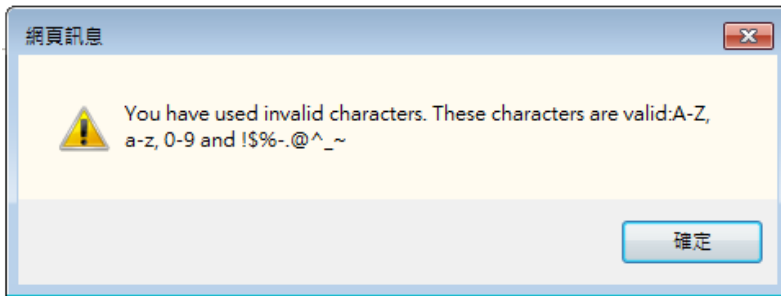

10-3. Another prompt will request for the password you just configured. Enter the password and then you can start configure your camera and see the live view.



11. Loosen, but not completely remove, the retention screws on lens module bracket to adjust the camera's shooting direction. You can pan, tilt, or rotate the camera lens.

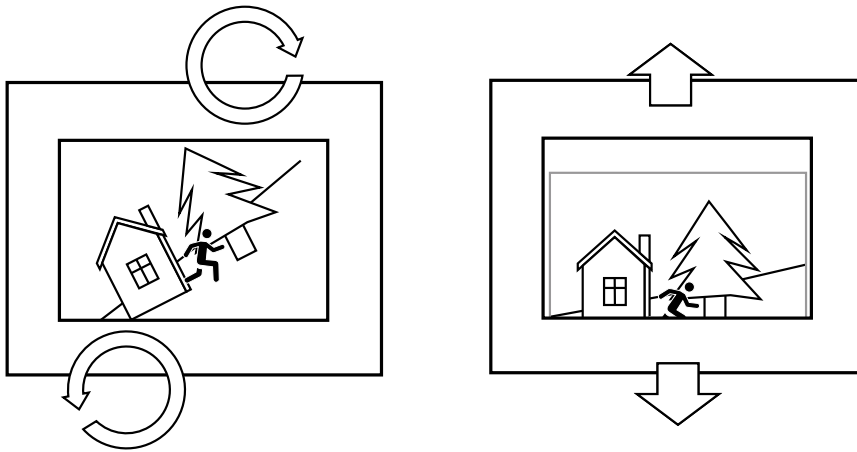
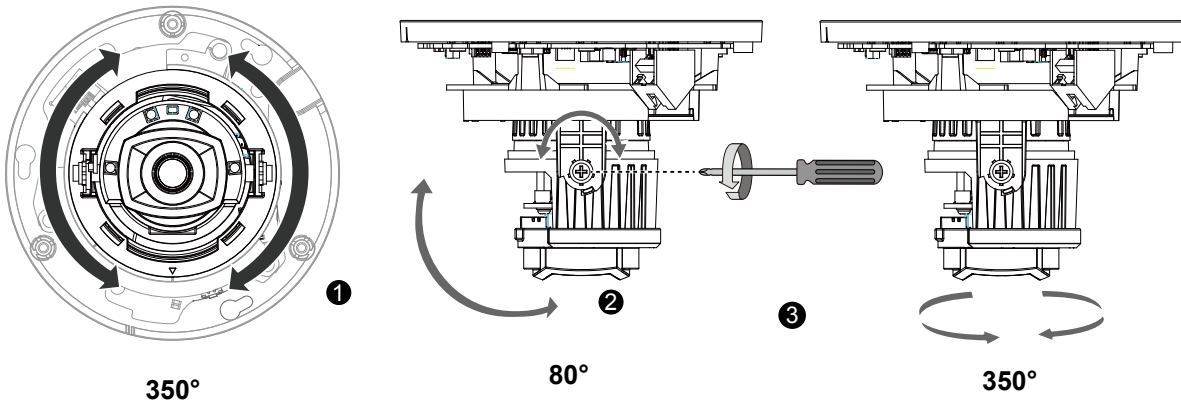

FD9189-HM

On a manual focus model, use the pullers to zoom and focus.

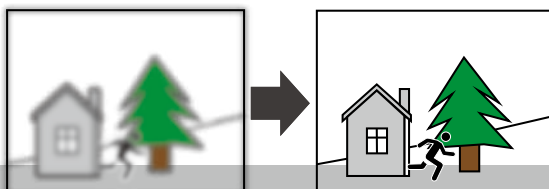
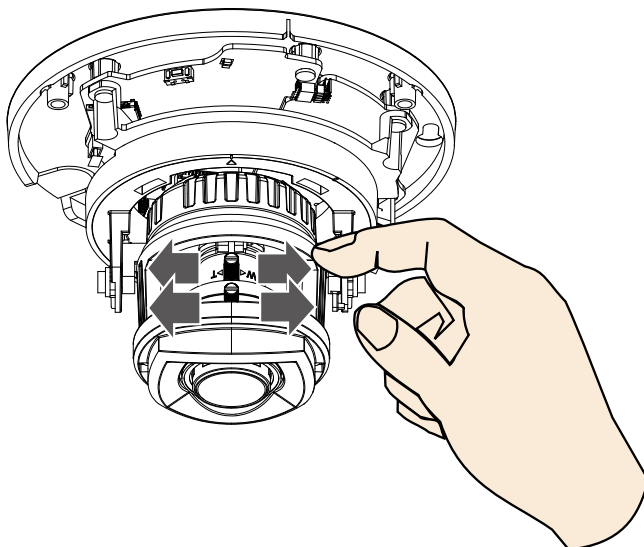



FD9189-HT: For the -HT and -EHT models, open a web console. From a web console, open the firmware configuration page. Enter the Configuration > Media > Image > Focus page. You will see a live stream on screen. If preferred, you can zoom in on the scene. Use the “Perform Auto Focus” function to automatically tune to a best image focus. Check the live view to ensure the image is in focus.

Configuration > Media > Image > Focus



12. Install the dome cover. Remove the protective sheet from the dome cover.

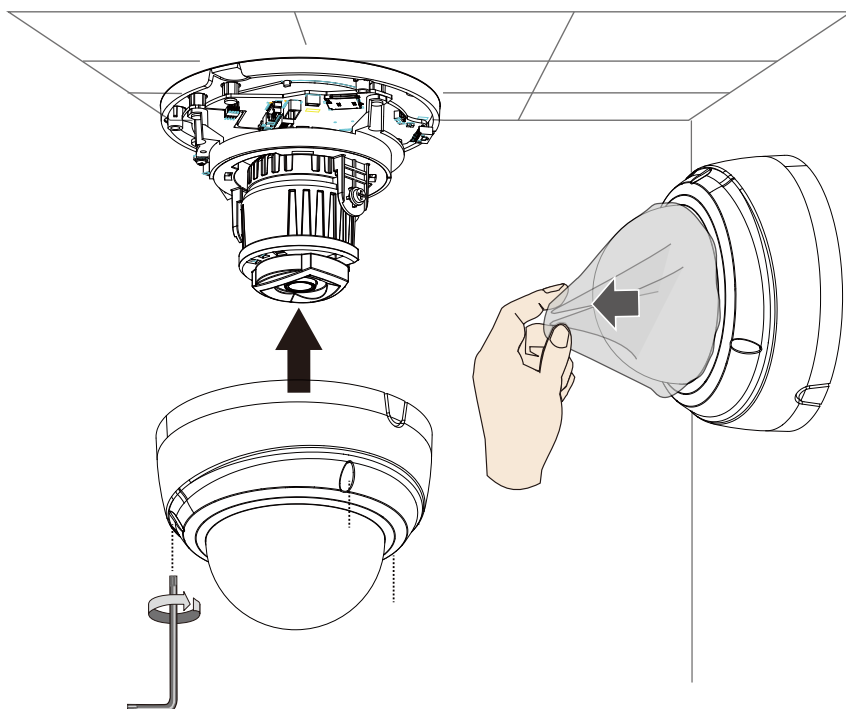

Hardware Installation (FD9389)

1. Jot down the camera's MAC address for later reference.

MAC

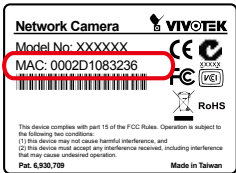

2. Remove the dome cover using the included T10 L wrench.

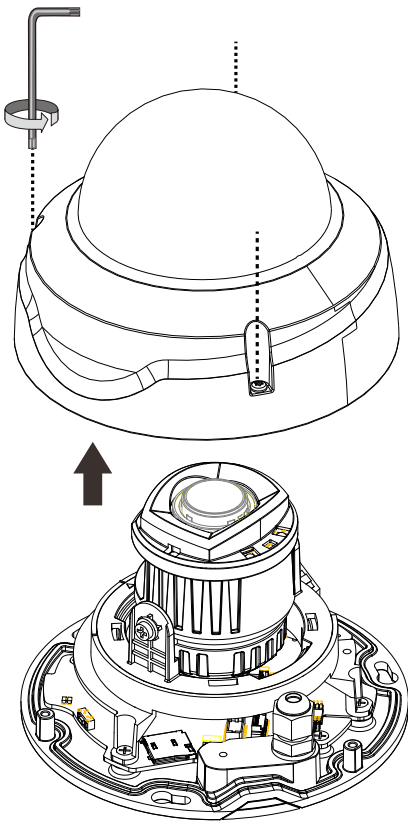

3. Install a MicroSD card if onboard storage is preferred.

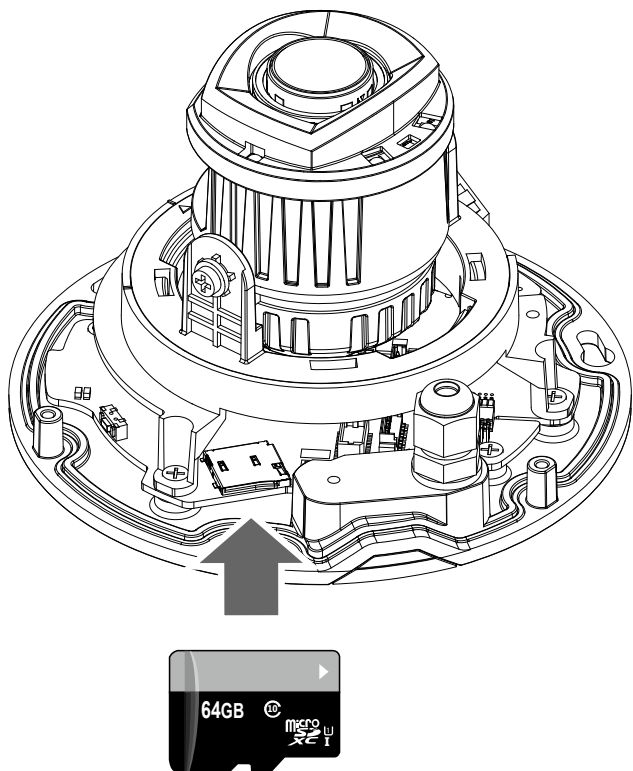

4. Use the alignment sticker to drill mounting holes on the ceiling or wall. If preferred, drill a routing hole. Install the camera by hammer in the wall anchors and drive screws.

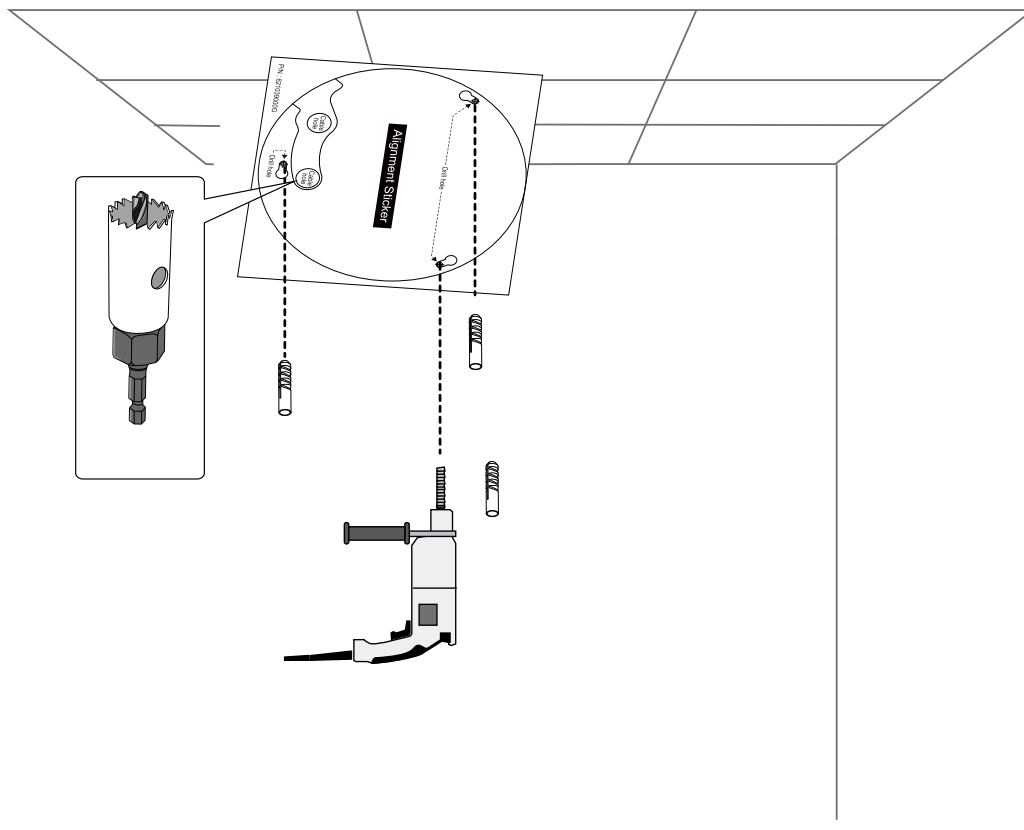



Refer to below drawing for the drill hole dimensions.

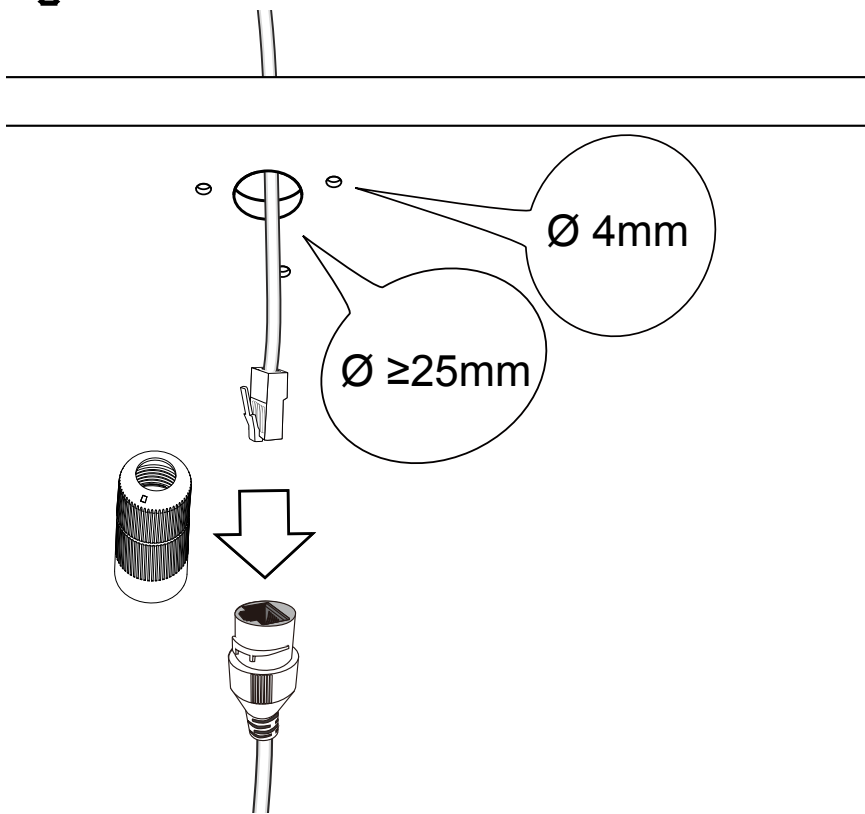

There are two camera configurations: with or without the Ethernet waterproof cable connector. For the installation of these configurations, refer to the following steps.

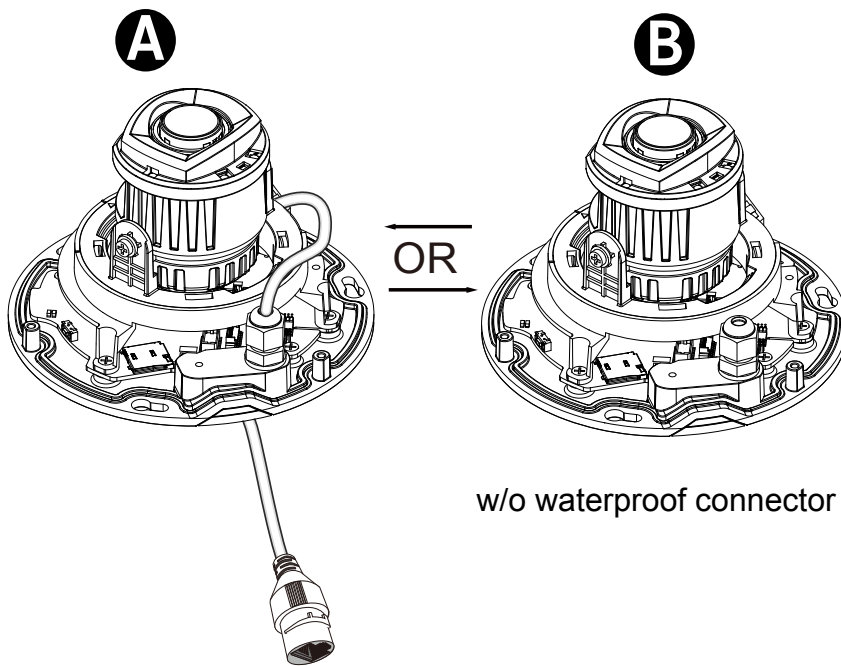

w/ waterproof connector

w/o waterproof connector

- A-1** Prepare an Ethernet cable and install the components of the waterproof cable gland to the cable. Install the cable gland components, rubber seal, claw, and sealing nut, to the Ethernet cable.

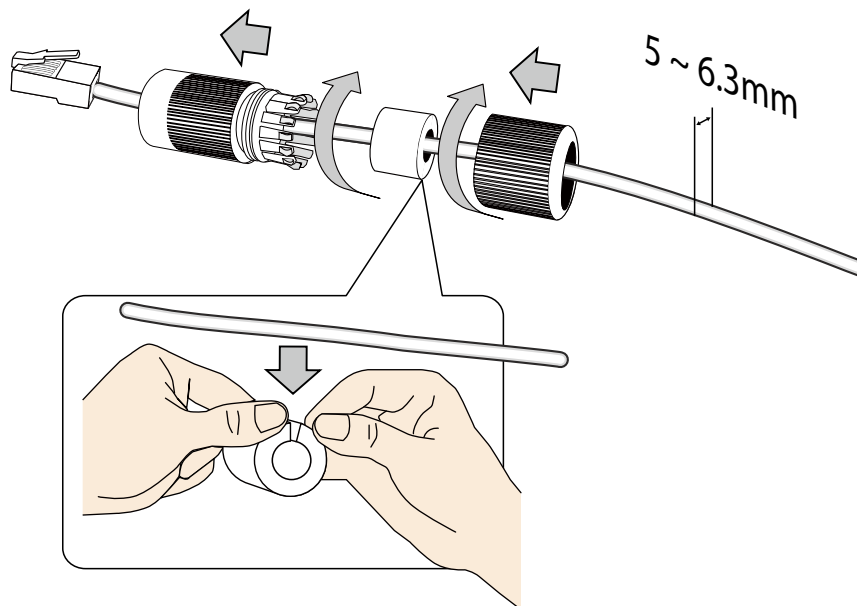

- A-2** Install and tighten up the components. There is a gasket around the RJ45 connector.

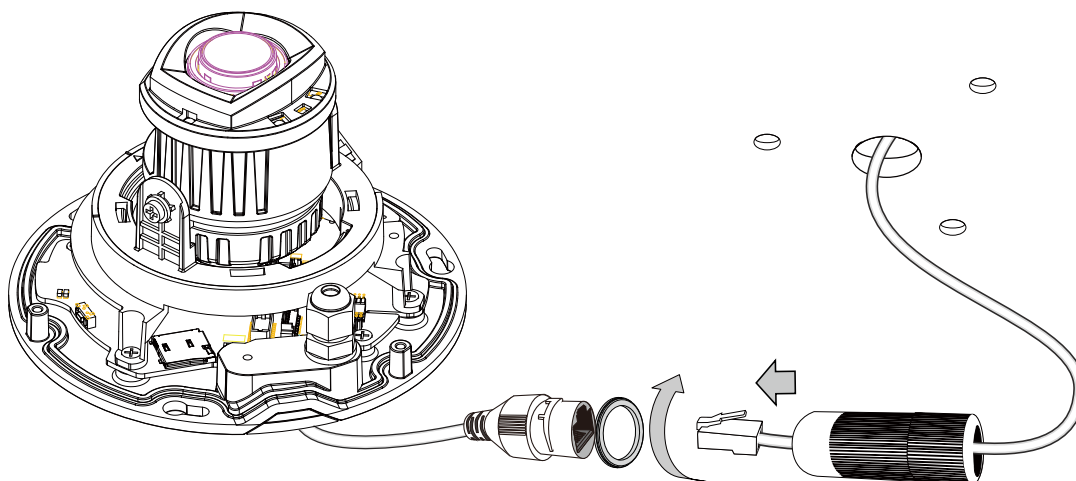

Continue to Step 5.

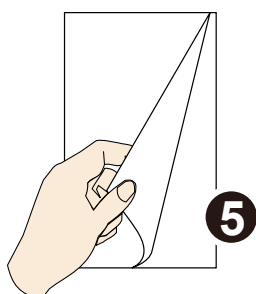

5

B-1

For a configuration without the waterproof connector, remove the cable gland components. Pass an Ethernet cable (without the RJ45 connector) through the routing hole on the camera.

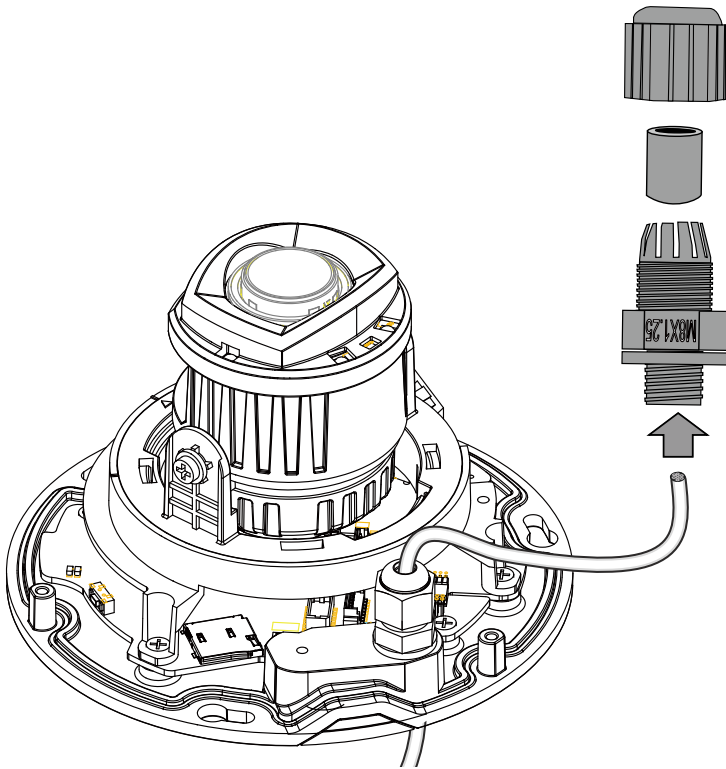

B-2

Remove part of cable sheath.

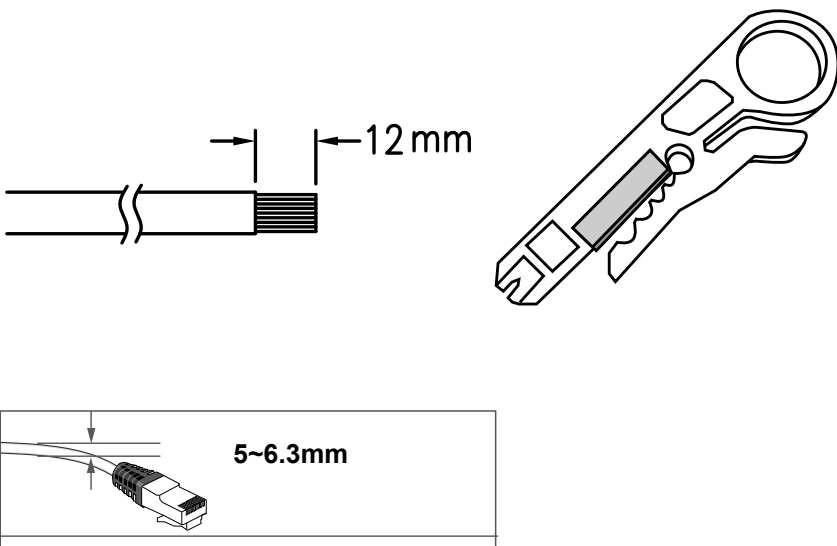

B-3 You will need an RJ45 crimping tool to attach the Ethernet wires to a connector. When done, connect the cable to the camera's Ethernet RJ45 socket.

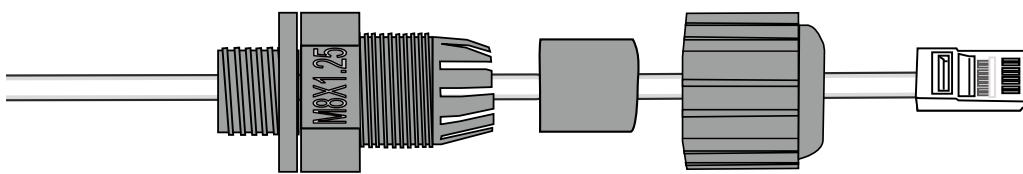
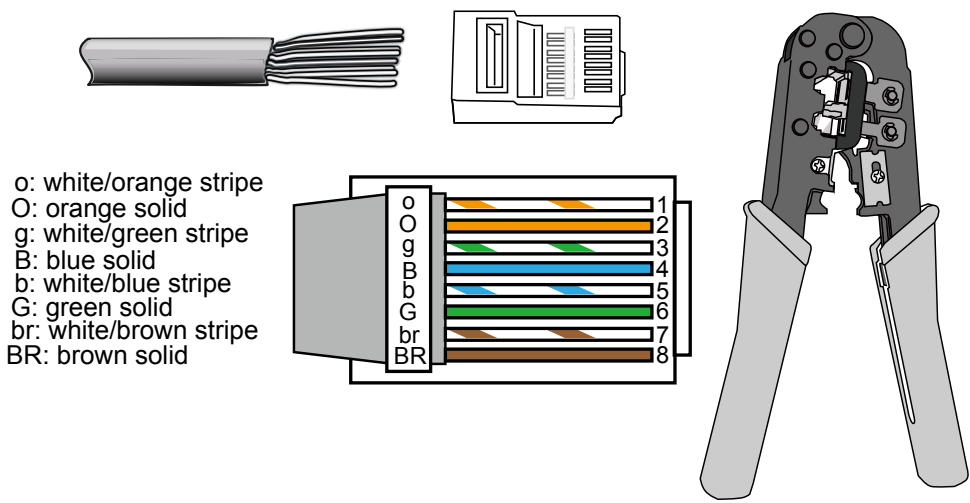

B-4 Install and tighten up the components of the waterproof cable gland. Leave 11.3cm of cable length inside the camera.

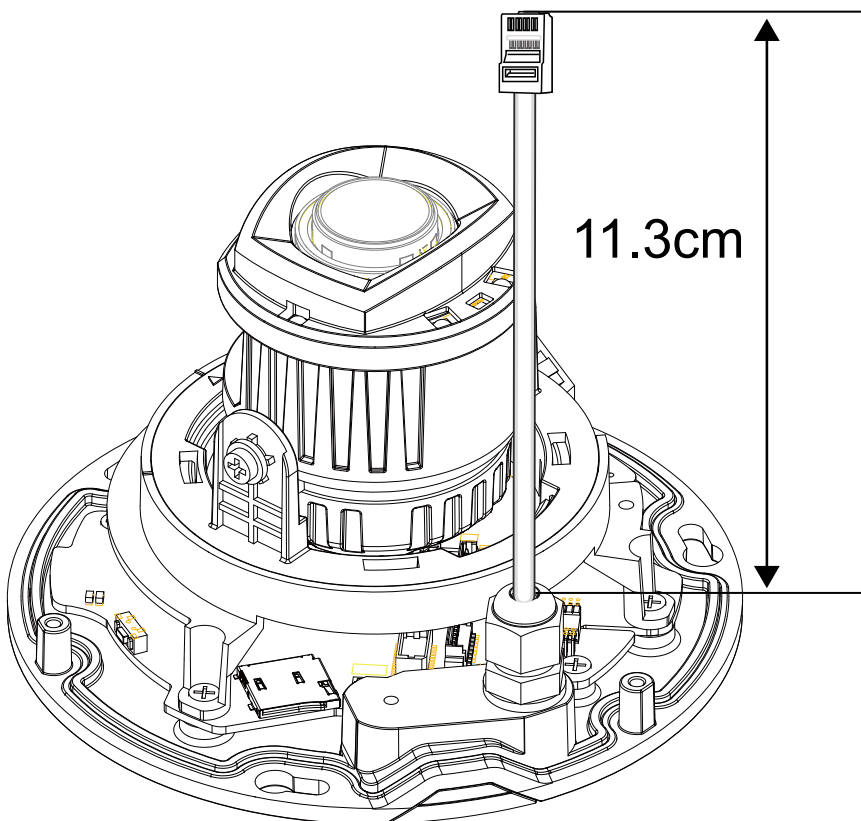

B-5

Connect the connector to the RJ45 Ethernet socket.

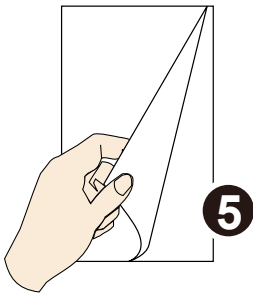
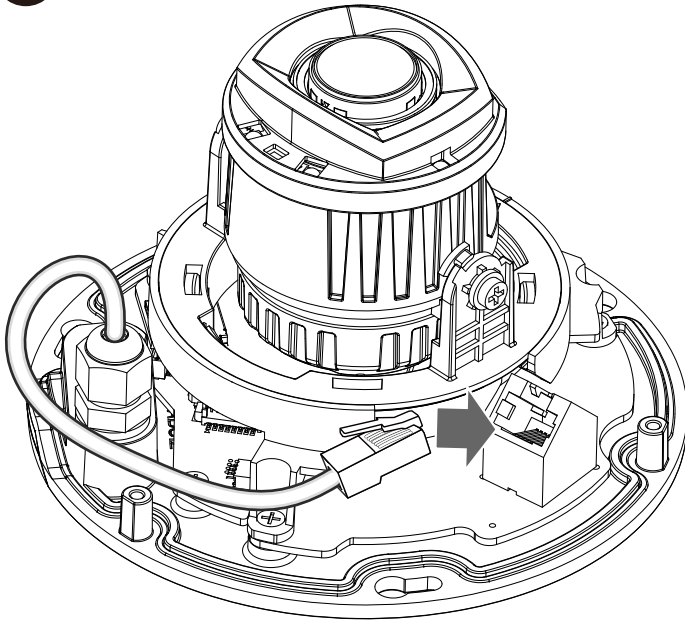

Continue to Step 5.

5. Install the camera to wall or ceiling by driving the included screws.

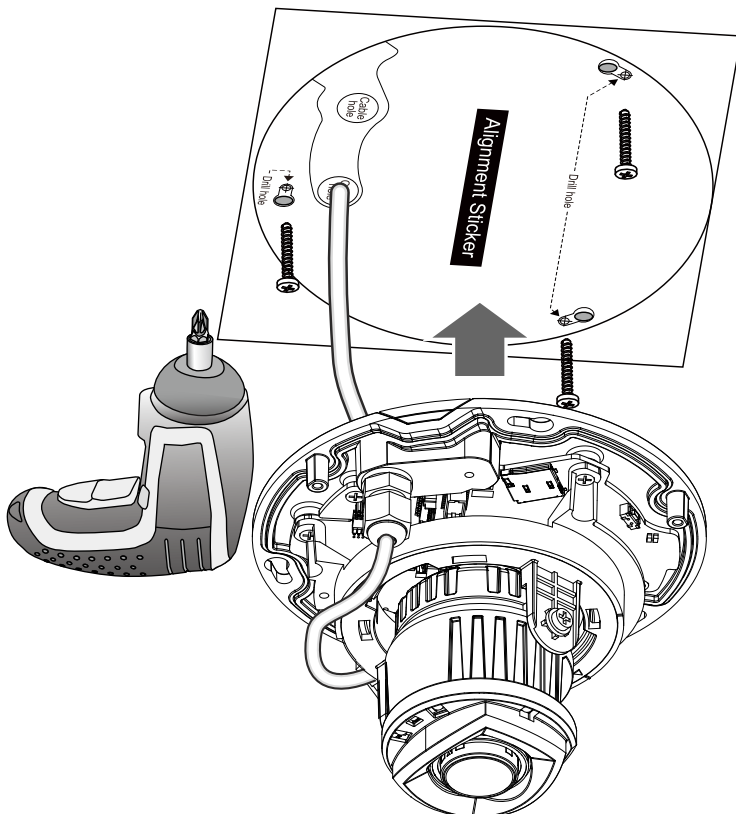

- Please visit VIVOTEK’s website to Install the "Shepherd" software utility. The program will search for VIVOTEK Video Receivers, Video Servers or Network Cameras on the same LAN.

Double-click on the camera’s MAC address to open a web console with the camera.



Software Installation

- Install the **Shepherd** utility, which helps you locate and configure your Network Camera in the local network. If your camera comes without the CD, go to VIVOTEK’s website, and locate the utility in the Downloads > Software page.



7-1. Run the Shepherd utility.

7-2. The program will conduct an analysis of your network environment.

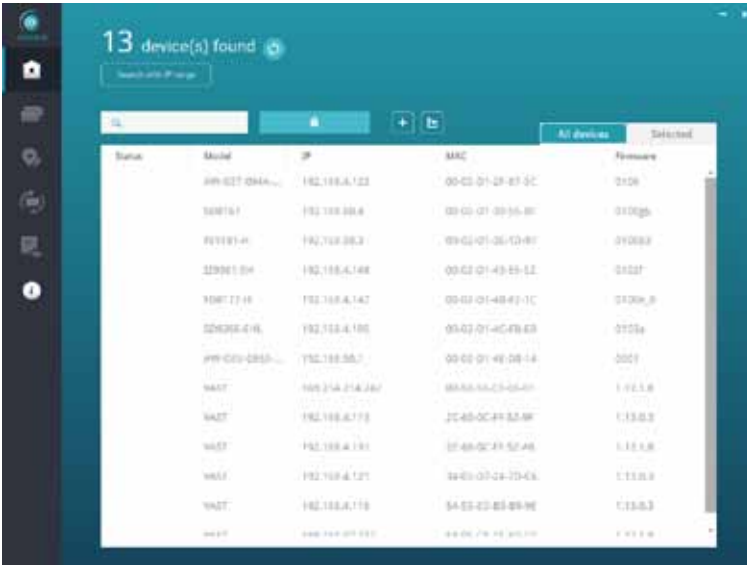

7-3. The program will search for all VIVOTEK network devices on the same LAN.

7-4. After a brief search, the installer window will prompt. Click on the MAC and model name that matches the one printed on the product label. You can then double-click on the address to open a management session with the Network Camera.

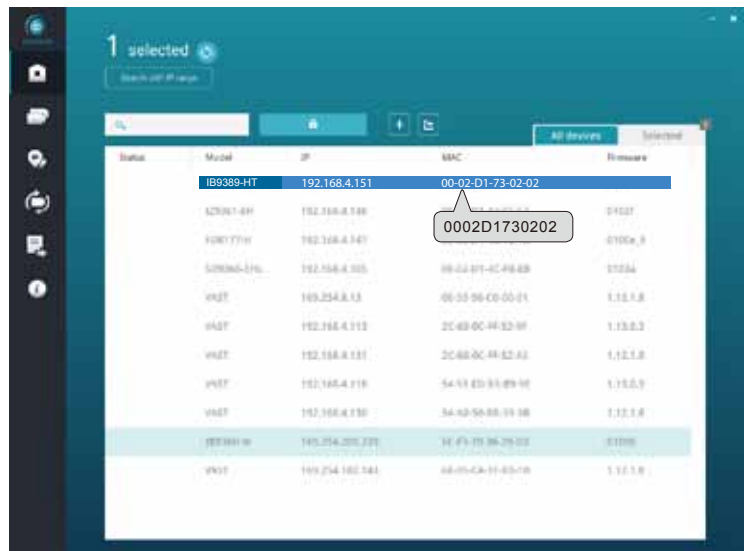

Forceful Password Configuration

8. The first time you log in to the camera, the firmware will prompt for a password configuration for security concerns.

8-1. Since your camera is used for the first time, there is no password. Enter “root” as the user name, and nothing for the password.



8-2. Enter the combination of alphabetic and numeric characters to fulfill the password strength requirement. The default name for the camera administrator is “root”, and can not be changed.

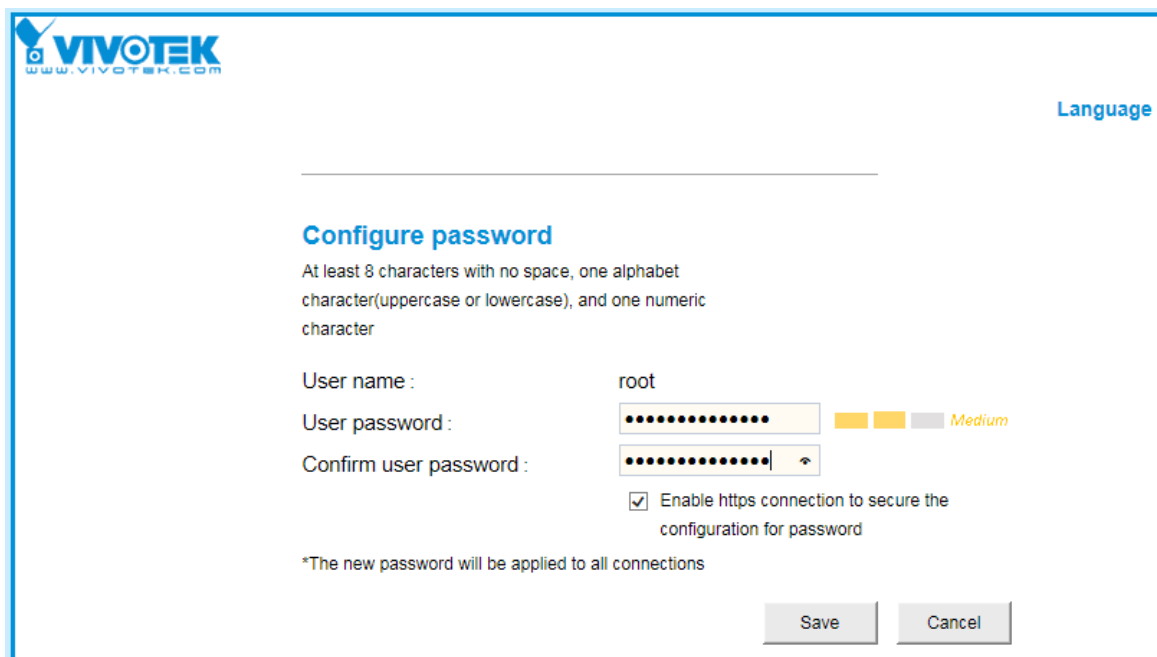

Some, but not all special ASCII characters are supported: !, \$, %, -, ., @, ^, _, and ~. You can use them in the password combination.

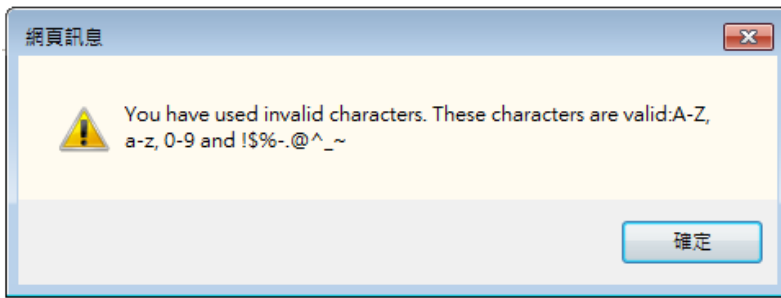

8-3. Another prompt will request for the password you just configured. Enter the password and then you can start configure your camera and see the live view.

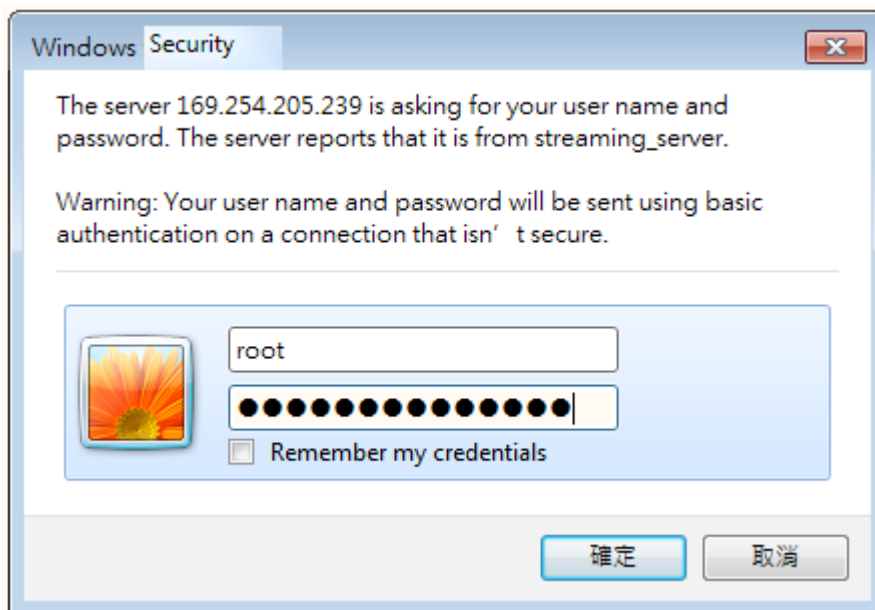

9. With a live view displayed on your laptop, adjust the zoom and focus to obtain an optimal image. Check the live view to ensure the image is in focus.

The "T" models comes with motorized focus lens. Use the Auto Focus function in firmware menu for best image.

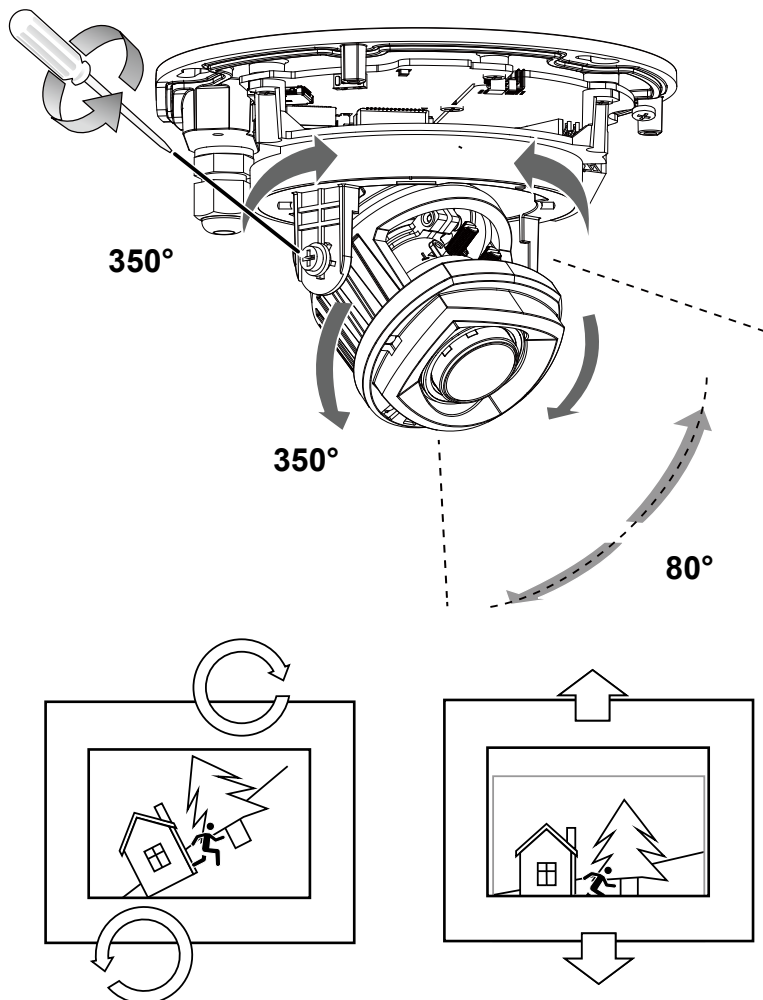



FD9389-HMV, -EHMV

For a manual focus model, use the zoom and focus pullers to adjust to an optimal image.

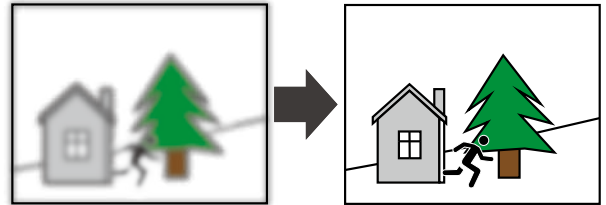
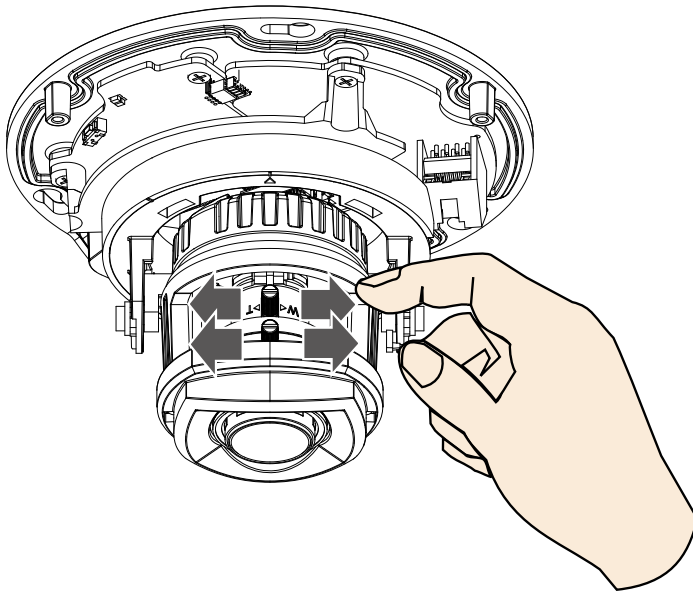

FD9389-HTV, -EHTV

Configuration > Media > Image > Focus

For the -HT and -EHT models, open a web console. From a web console, open the firmware configuration page. Enter the Configuration > Media > Image > Focus page. You will see a live stream on screen. If preferred, you can zoom in on the scene. Use the “Perform Auto Focus” function to automatically tune to a best image focus. Check the live view to ensure the image is in focus.



10. Replace the desiccant bags on the side of the cameras. Whenever you open the dome cover, you should replace the desiccants.

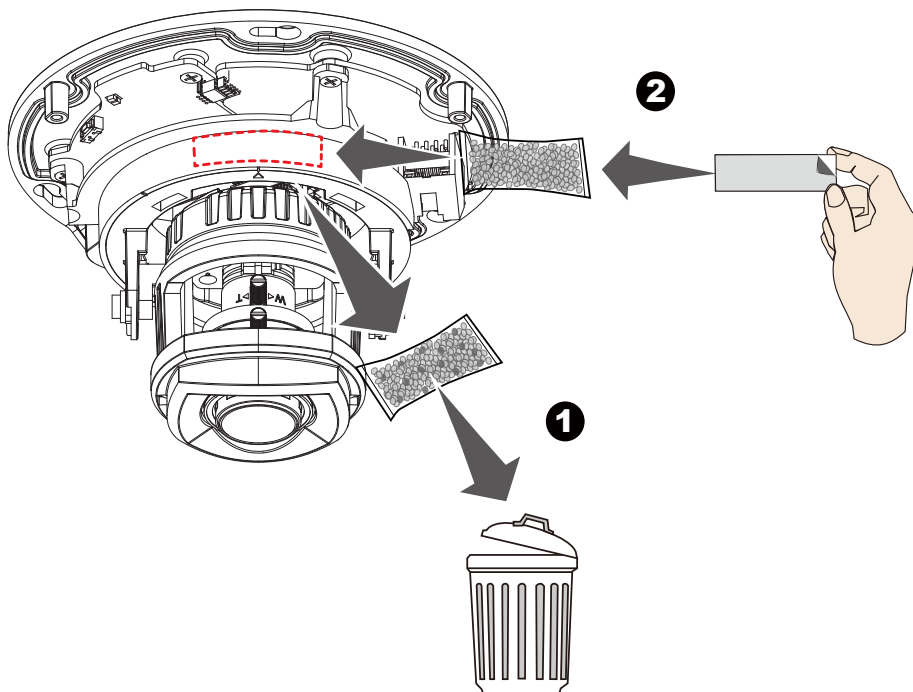

11. Install the dome cover. Remove the protective sheet from the dome cover.

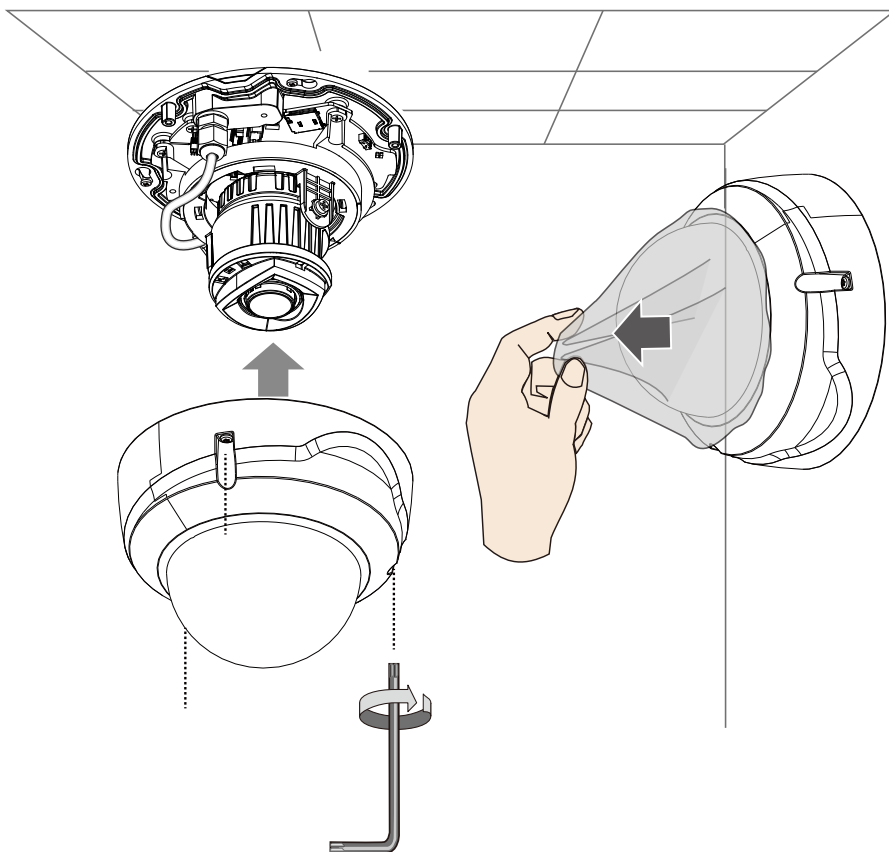

LED Definitions

	Item	LED status	Description
LED Definition	1	Steady Red	Powered and system booting, or network failed
		Red LED off	Power off
		Green LED off	Network is disconnected
	2	Steady Red and Green LED blinks every 1 sec.	Connected to network
	3	Green LED blinks every 1 sec. and RED LED blinks consecutively every 0.15 sec.	Upgrading firmware
	4	Green and RED blink every 0.15 sec, Green and RED light on, then blink again.	Restoring defaults
	5	RED LED is on, Green LED blinks and RED LED is constantly on.	Status after a reset (network connected)
		Green and RED LEDs are constantly on.	Status after a reset (network disconnected)

Hardware Reset

The reset button is used to reset the system or restore the factory default settings. Sometimes resetting the system can return the camera to normal operation. If the system problems remain after reset, restore the factory settings and install again.

Reset: Press the recessed reset button. Wait for the Network Camera to reboot.

Restore: Press and hold the reset button until the status LED rapidly blinks. Note that all settings will be restored to factory default. Upon successful restore, the status LED will blink green and red during normal operation.

SD/SDHC/SDXC Card Capacity

This network camera is compliant with **SD/SDHC/SDXC 16GB / 8GB / 32GB / 64GB** and other preceding standard SD cards.

Network Deployment

General Connection (PoE)

● When using a PoE-enabled switch

The Network Camera is PoE-compliant, allowing transmission of power and data via a single Ethernet cable. Follow the below illustration to connect the Network Camera to a PoE-enabled switch via Ethernet cable.

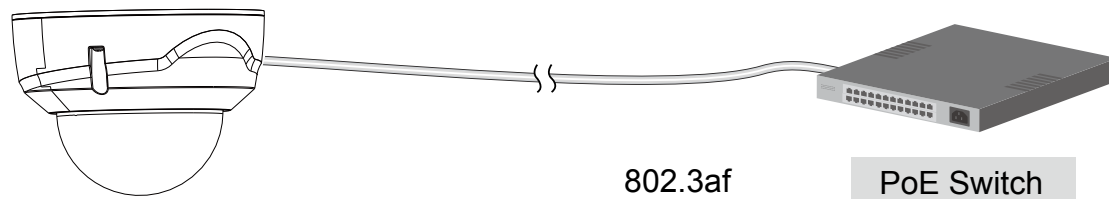

802.3at for FD9389-EHV, -EHMV, and -EHTV

● When using a non-PoE switch

Use a PoE power injector (optional) to connect between the Network Camera and a non-PoE switch.

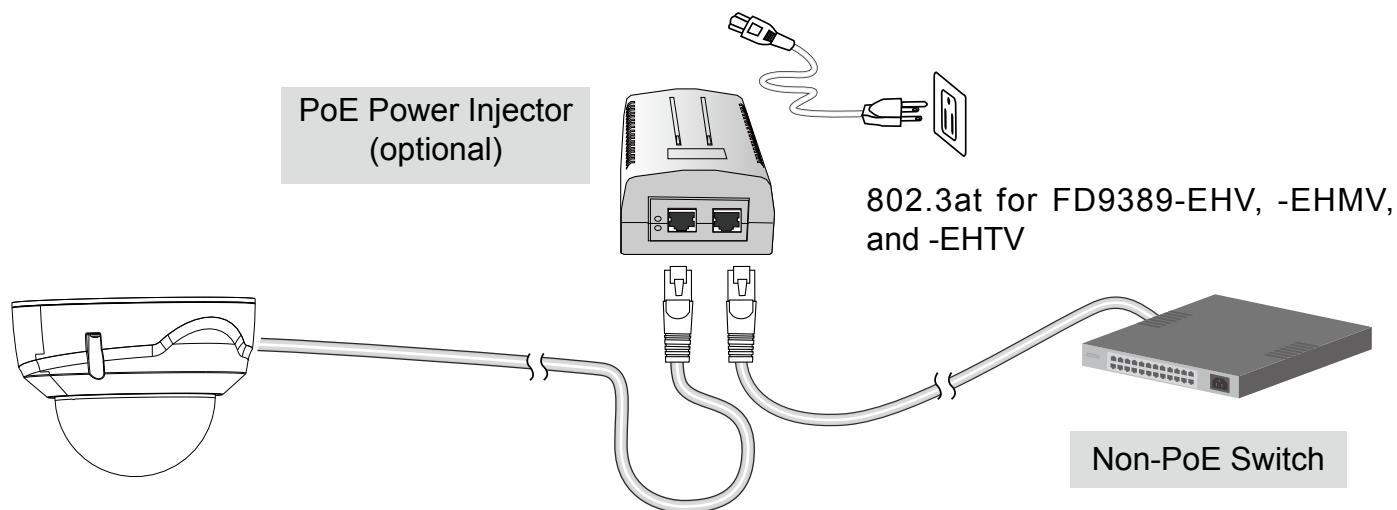

Ready to Use

1. A browser session with the Network Camera should prompt as shown below.
2. You should be able to see live video from your camera. You may also install the 32-channel recording software from the software CD in a deployment consisting of multiple cameras. For its installation details, please refer to its related documents.



IMPORTANT:

- The "E" models, e.g., FD9389-EHV, -EHMV, and -EHTV, are able to operate in low temperature environments. However, when starting these cameras in a very low temperature condition, e.g., -40°C , the embedded heater may take half an hour to warm up the camera. When the temperature within the canister reaches -10°C , the camera automatically starts.

Internet connection via a router

Before setting up the Network Camera over the Internet, make sure you have a router and follow the steps below.

1. Connect your Network Camera behind a router, the Internet environment is illustrated below. Regarding how to obtain your IP address, please refer to Software Installation on page 20 for details.

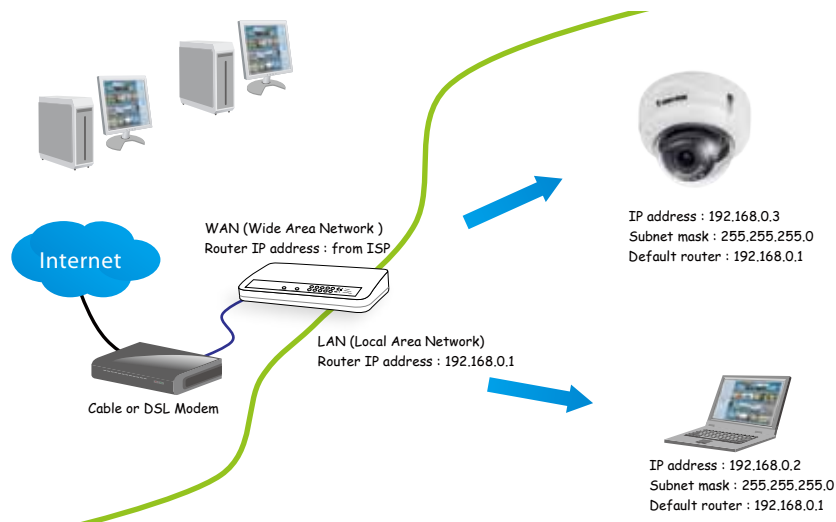

2. In this case, if the Local Area Network (LAN) IP address of your Network Camera is 192.168.0.3, please forward the following ports for the Network Camera on the router.

- HTTP port: default is 80
- RTSP port: default is 554
- RTP port for video: default is 5556
- RTCP port for video: default is 5557

If you have changed the port numbers on the Network page, please open the ports accordingly on your router. For information on how to forward ports on the router, please refer to your router's user's manual.

3. Find out the public IP address of your router provided by your ISP (Internet Service Provider). Use the public IP and the secondary HTTP port to access the Network Camera from the Internet. Please refer to Network Type on page 96 for details.

Internet connection with static IP

Choose this connection type if you are required to use a static IP for the Network Camera. Please refer to LAN setting on page 95 for details.

Internet connection via PPPoE (Point-to-Point over Ethernet)

Choose this connection type if you are connected to the Internet via a DSL Line. Please refer to PPPoE on page 96 for details.

For example, your router and IP settings may look like this:

Device	IP Address: internal port	IP Address: External Port (Mapped port on the router)
Public IP of router	122.146.57.120	
LAN IP of router	192.168.2.1	
Camera 1	192.168.2.10:80	122.146.57.120:8000
Camera 2	192.168.2.11:80	122.146.57.120:8001
...

Configure the router, virtual server or firewall, so that the router can forward any data coming into a preconfigured port number to a network camera on the private network, and allow data from the camera to be transmitted to the outside of the network over the same path.

From	Forward to
122.146.57.120:8000	192.168.2.10:80
122.146.57.120:8001	192.168.2.11:80
...	...

When properly configured, you can access a camera behind the router using the HTTP request as follows: `http://122.146.57.120:8000`

If you change the port numbers on the Network configuration page, please open the ports accordingly on your router. For example, you can open a management session with your router to configure access through the router to the camera within your local network. Please consult your network administrator for router configuration if you have troubles with the configuration.

For more information with network configuration options (such as that of streaming ports), please refer to Configuration > Network Settings. VIVOTEK also provides the automatic port forwarding feature as an NAT traversal function with the precondition that your router must support the UPnP port forwarding feature.

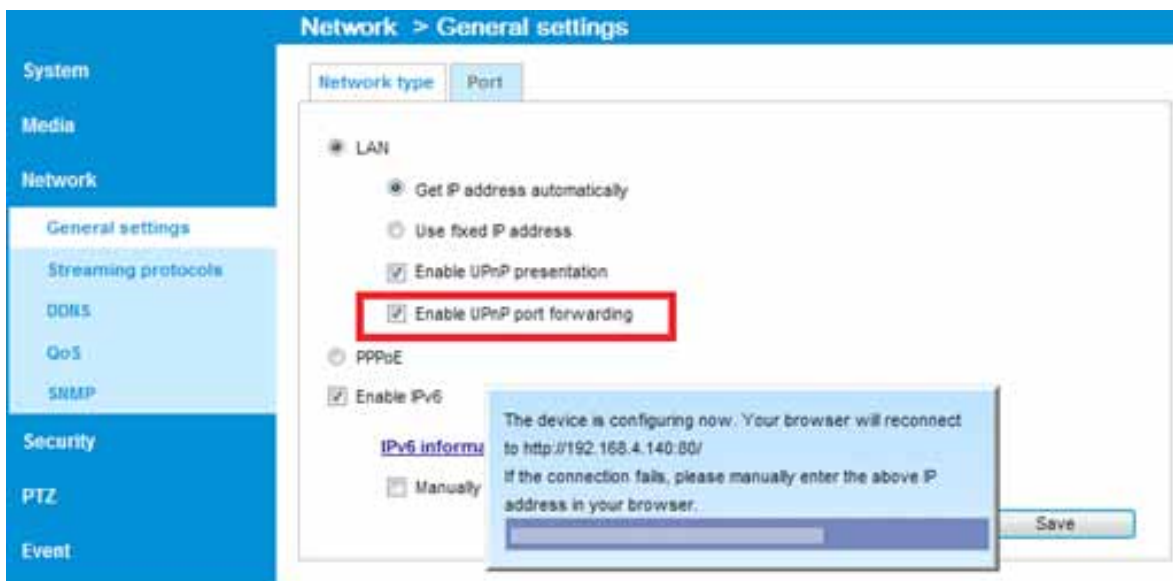

Accessing the Network Camera

This chapter explains how to access the Network Camera through web browsers, RTSP players, 3GPP-compatible mobile devices, and VIVOTEK recording software.

Using Web Browsers

Use Installation Wizard 2 (IW2) to access the Network Cameras on LAN.

If your network environment is not a LAN, follow these steps to access the Network Camera:

1. Launch your web browser (e.g., Microsoft® Internet Explorer or Mozilla Firefox).
2. Enter the IP address of the Network Camera in the address field. Press **Enter**.
3. Live video will be displayed in your web browser.
4. If it is the first time installing the VIVOTEK network camera, an information bar will prompt as shown below. Follow the instructions to install the required plug-in on your computer.

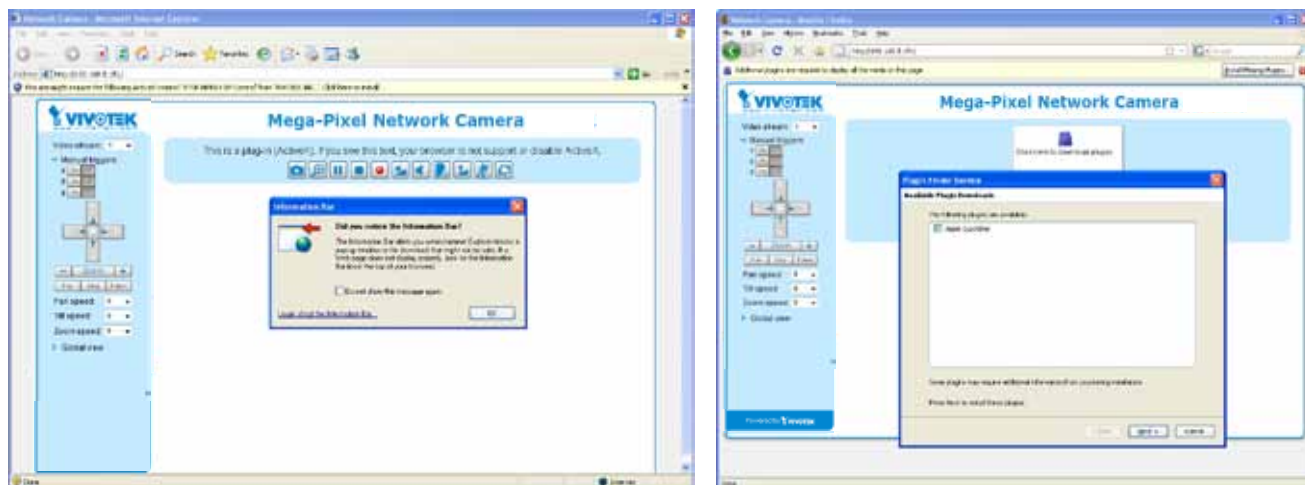

NOTE:

- For Mozilla Firefox or Chrome users, your browser will use QuickTime to stream the live video. If you don't have QuickTime on your computer, please download it first, then launch the web browser.

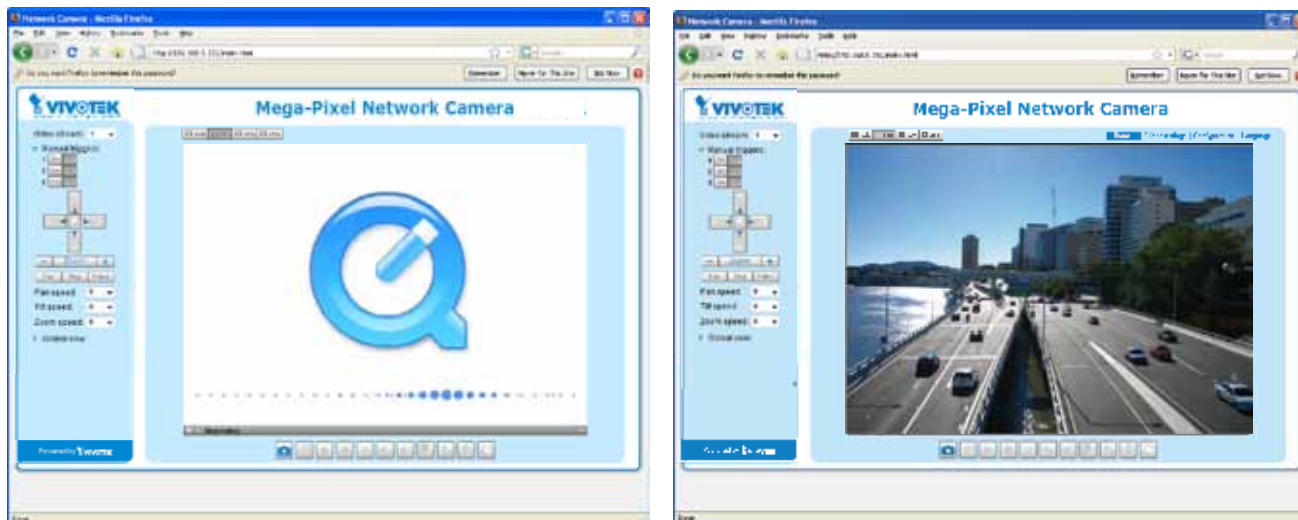

- ▶ *By default, the Network Camera is not password-protected. To prevent unauthorized access, it is highly recommended to set a password for the Network Camera. For more information about how to enable password protection, please refer to Security on page 113.*
- ▶ *If you see a dialog box indicating that your security settings prohibit running ActiveX® Controls, please enable the ActiveX® Controls for your browser.*

1. Choose **Tools > Internet Options > Security > Custom Level**.

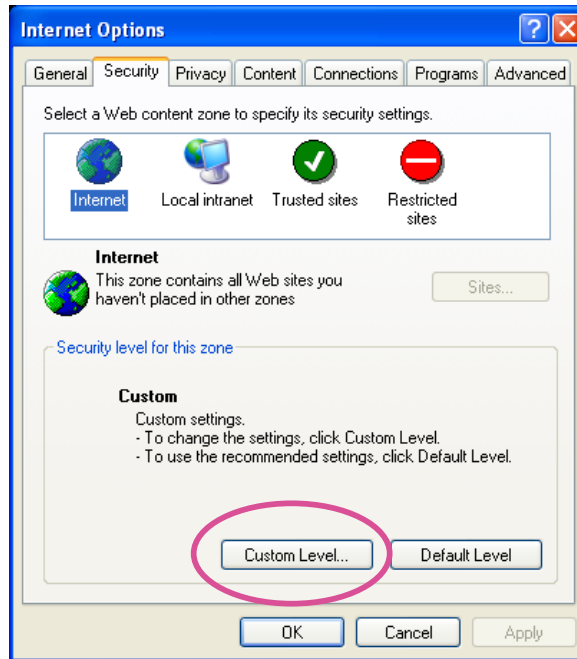

2. Look for **Download signed ActiveX® controls**; select **Enable or Prompt**. Click **OK**.

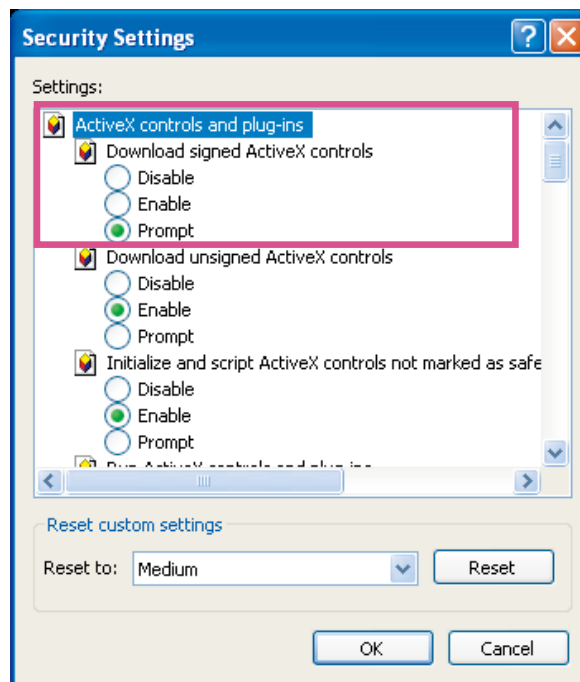

3. Refresh your web browser, then install the ActiveX® control. Follow the instructions to complete installation.

⚠ IMPORTANT:

- Currently the Network Camera utilizes a 32-bit ActiveX plugin. You CAN NOT open a management/view session with the camera using a 64-bit IE browser.
- If you encounter this problem, try execute the Iexplore.exe program from C:\Windows\SysWOW64. A 32-bit version of IE browser will be installed.
- On Windows 7, the 32-bit explorer browser can be accessed from here:
[C:\Program Files \(x86\)\Internet Explorer\Iexplore.exe](C:\Program Files (x86)\Internet Explorer\Iexplore.exe)
- If you open a web session from the Shepherd utility, a 32-bit IE browser will be opened.

💡 Tips:

1. The onscreen Java control can malfunction under the following situations: A PC connects to different cameras that are using the same IP address (or the same camera running different firmware versions). Removing your browser cookies will solve this problem.
2. If you encounter problems with displaying the configuration menus or UI items, try disable the Compatibility View on IE8 or IE9.



You may also press the F12 key to open the developer tools utility, and then change the Browser Mode to the genuine IE8 or IE9 mode.

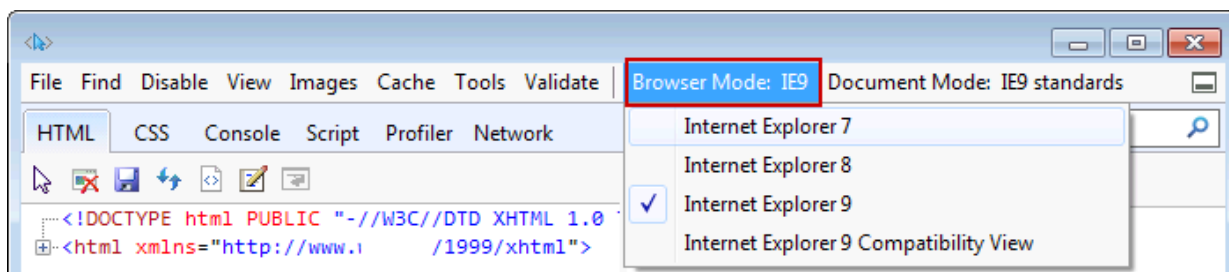

- In the event of plug-in compatibility issues, you may try to uninstall the plug-in that was previously installed.

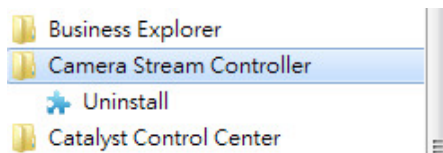

Using RTSP Players

To view the streaming media using RTSP players, you can use one of the following players that support RTSP streaming.



Quick Time Player



VLC media player

1. Launch the RTSP player.
2. Choose File > Open URL. A URL dialog box will pop up.
3. The address format is `rtsp://<ip address>:<rtsp port>/<RTSP streaming access name for stream1 or stream2>`

As most ISPs and players only allow RTSP streaming through port number 554, please set the RTSP port to 554. For more information, please refer to RTSP Streaming on page 103.

For example:

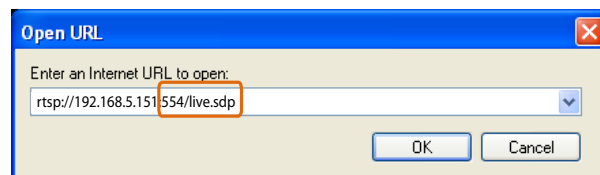

4. The live video will be displayed in your player.
For more information on how to configure the RTSP access name, please refer to RTSP Streaming on page 103 for details.



Using 3GPP-compatible Mobile Devices

To view the streaming media through 3GPP-compatible mobile devices, make sure the Network Camera can be accessed over the Internet. For more information on how to set up the Network Camera over the Internet, please refer to Setup the Network Camera over the Internet on page 37.

To utilize this feature, please check the following settings on your Network Camera:

1. Because most players on 3GPP mobile phones do not support RTSP authentication, make sure the authentication mode of RTSP streaming is set to disable.
For more information, please refer to RTSP Streaming on page 103.
2. As the the bandwidth on 3G networks is limited, you will not be able to use a large video size. Please set the video streaming parameters as listed below.
For more information, please refer to Stream settings on page 84.

Video Mode	H.264
Frame size	176 x 144
Maximum frame rate	5 fps
Intra frame period	1S
Video quality (Constant bit rate)	40kbps

3. As most ISPs and players only allow RTSP streaming through port number 554, please set the RTSP port to 554. For more information, please refer to RTSP Streaming on page 103.
4. Launch the player on the 3GPP-compatible mobile devices (e.g., QuickTime).
5. Type the following URL commands into the player.
The address format is `rtsp://<public ip address of your camera>:<rtsp port>/<RTSP streaming access name for stream # with small frame size and frame rate>`.
For example:

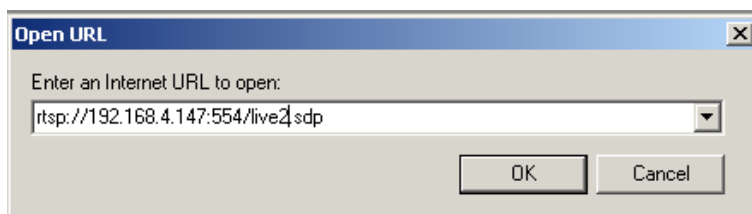

You can configure Stream #2 into the suggested stream settings as listed above for live viewing on a mobile device.

Using VIVOTEK Recording Software

You can download a VAST recording software, allowing simultaneous monitoring and video recording for multiple Network Cameras. Please install the recording software; then launch the program to add the Network Camera to the Channel list. For detailed information about how to use the recording software, please refer to the user's manual of the software or download it from <http://www.vivotek.com>.

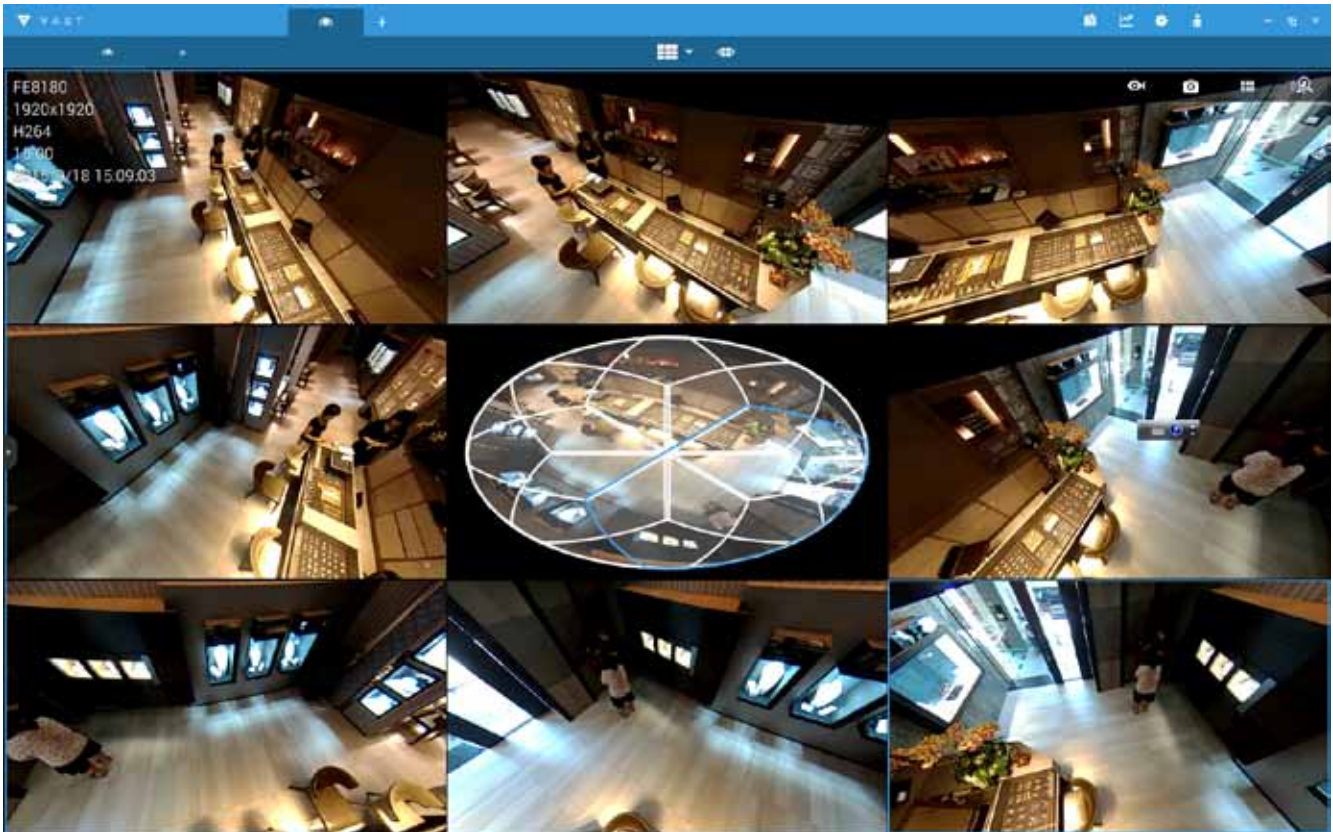

Tips:

1. If you encounter problems with displaying live view or the onscreen plug-in control, you may try to remove the plug-ins that might have been installed on your computer. Remove the following folder: C:\Program Files (x86)\Camera Stream Controller\.
2. If you forget the root (administrator) password for the camera, you can restore the camera defaults by pressing the reset button for longer than 5 seconds.
3. If DHCP is enabled in your network, and the camera cannot be accessed, run the Shepherd utility to search the network. If the camera has been configured with fixed IP that does not comply with your local network, you may see its default IP 169.254.x.x. If you still cannot find the camera, you can restore the camera to its factory defaults.
4. If you change your network parameters, e.g., added a connection to a LAN card, re-start the Shepherd utility.

Main Page

This chapter explains the layout of the main page. It is composed of the following sections: VIVOTEK INC. Logo, Host Name, Camera Control Area, Configuration Area, Menu, and Live Video Window.



VIVOTEK INC. Logo

Click this logo to visit the VIVOTEK website.

Host Name

The host name can be customized to fit your needs. The name can be changed especially there are many cameras in your surveillance deployment. For more information, please refer to System on page 58.

Camera Control Area

Video Stream: This Network Camera supports multiple streams (streams 1 and 2) simultaneously. You can select any of them for live viewing. For more information about multiple streams, please refer to page 84 for detailed information.

Manual Trigger: Click to enable/disable an event trigger manually. Please configure an event setting on the Application page before you enable this function. A total of 3 event configuration can be configured. For more information about event setting, please refer to page 131. If you want to hide this item on the homepage, please go to **Configuration > System > Homepage Layout > General settings > Customized button** to deselect the "show manual trigger button" checkbox.

Configuration Area

Client Settings: Click this button to access the client setting page. For more information, please refer to Client Settings on page 52.

Configuration: Click this button to access the configuration page of the Network Camera. It is suggested that a password be applied to the Network Camera so that only the administrator can configure the Network Camera. For more information, please refer to Configuration on page 57.

Language: Click this button to choose a language for the user interface. Language options are available in: English, Deutsch, Español, Français, Italiano, 日本語, Português, 簡體中文, and 繁體中文. Please note that you can also change a language on the Configuration page; please refer to page 57.

Hide Button

You can click the hide button to hide or display the control panel.

Resize Buttons



Click the Auto button, the video cell will resize automatically to fit the monitor.

Click 100% is to display the original homepage size.

Click 50% is to resize the homepage to 50% of its original size.

Click 25% is to resize the homepage to 25% of its original size.

Live Video Window

- The following window is displayed when the video mode is set to H.264 or H.265:
H.265/264 Protocol and Media Options



Video Title: The video title can be configured. For more information, please refer to Video Settings on page 70.

H.264 or H. 265 Protocol and Media Options: The transmission protocol and media options for H.264 or H.265 video streaming. For further configuration, please refer to Client Settings on page 52.

Time: Display the current time. For further configuration, please refer to Media > Image > Genral settings on page 70.

Title and Time: The video title and time can be stamped on the streaming video. For further configuration, please refer to Media > Image > General settings on page 74.

PTZ Panel: This Network Camera supports “digital” (e-PTZ) pan/tilt/zoom control, which allows roaming a smaller view frame within a large view frame. Please refer to PTZ settings on page 128 for detailed information.

Global View: Click on this item to display the Global View window. The Global View window contains a full view image (the largest frame size of the captured video) and a floating frame (the viewing region of the current video stream). The floating frame allows users to control the e-PTZ function (Electronic Pan/Tilt/Zoom). For more information about e-PTZ operation, please refer to E-PTZ Operation on page 128. For more information about how to set up the viewing region of the current video stream, please refer to page 128.

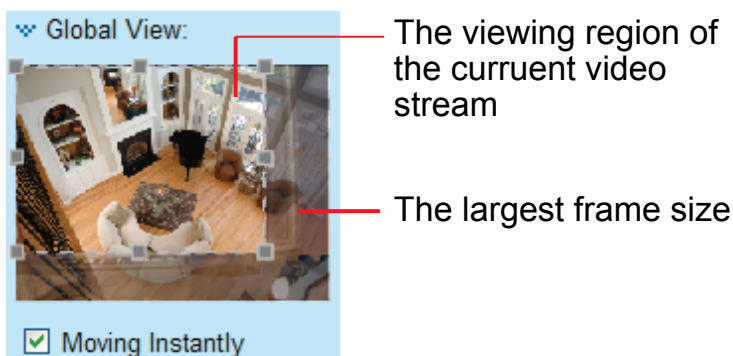



Note that the PTZ buttons on the panel are not operational unless you are showing only a portion of the full image. If the live view window is displaying the full view, the PTZ buttons are not functional.



Video Control Buttons: Depending on the Network Camera model and Network Camera configuration, some buttons may not be available.

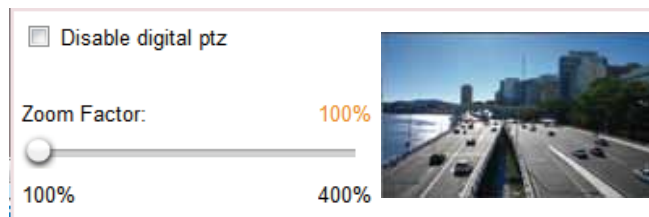

 **Snapshot:** Click this button to capture and save still images. The captured images will be displayed in a pop-up window. Right-click the image and choose **Save Picture As** to save it in JPEG (*.jpg) or BMP (*.bmp) format.

 **Digital Zoom:** Click and uncheck “Disable digital zoom” to enable the zoom operation. The navigation screen indicates the part of the image being magnified. To control the zoom level, drag the slider bar. To move to a different area you want to magnify, drag the navigation screen.



 **Pause:** Pause the transmission of the streaming media. The button becomes the  **Resume** button after clicking the Pause button.

 **Stop:** Stop the transmission of the streaming media. Click the  **Resume** button to continue transmission.

 **Start MP4 Recording:** Click this button to record video clips in MP4 file format to your computer. Press the  **Stop MP4 Recording** button to end recording. When you exit the web browser, video recording stops accordingly. To specify the storage destination and file name, please refer to MP4 Saving Options on page 53 for details.



NOTE:

1. For a megapixel camera, it is recommended to use monitors of the 24" size or larger, and are capable of 1600x1200 or better resolutions.
2. Below are the defaults for **Audio** settings:
 - For cameras with built-in microphone: **Not Muted.**
 - For cameras without built-in microphone: **Muted.**

- The following window is displayed when the video mode is set to MJPEG:





Video Title: The video title can be configured. For more information, please refer to Media > Image on page 74.

Time: Display the current time. For more information, please refer to Media > Image on page 74.



Title and Time: Video title and time can be stamped on the streaming video. For more information, please refer to Media > Image on page 74.

Video Control Buttons: Depending on the Network Camera model and Network Camera configuration, some buttons may not be available.

 **Snapshot:** Click this button to capture and save still images. The captured images will be displayed in a pop-up window. Right-click the image and choose **Save Picture As** to save it in JPEG (*.jpg) or BMP (*.bmp) format.

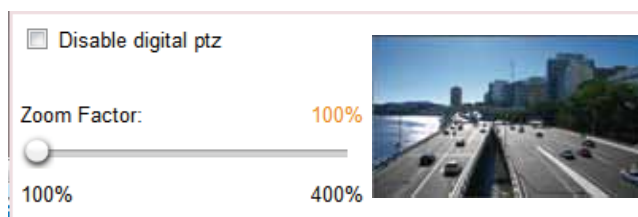
 **Digital Zoom:** Click and uncheck “Disable digital zoom” to enable the zoom operation. The navigation screen indicates the part of the image being magnified. To control the zoom level, drag the slider bar. To move to a different area you want to magnify, drag the navigation screen.



 **Start MP4 Recording:** Click this button to record video clips in MP4 file format to your computer. Press the  **Stop MP4 Recording** button to end recording. When you exit the web browser, video recording stops accordingly. To specify the storage destination and file name, please refer to MP4 Saving Options on page 53 for details.

 **Full Screen:** Click this button to switch to full screen mode. Press the “Esc” key to switch back to normal mode.

Client Settings

This chapter explains how to select the stream transmission mode and saving options on the local computer. When completed with the settings on this page, click **Save** on the page bottom to enable the settings.

H.265/H.264 Media Options

Select to stream video or audio data or both. This is enabled only when the video mode is set to H.264.

H.265/H.264 Protocol Options

H.265/H.264 protocol options

TCP

Depending on your network environment, there are four transmission modes of H.264 streaming:

UDP unicast: This protocol allows for more real-time audio and video streams. However, network packets may be lost due to network burst traffic and images may be broken. Activate UDP connection when occasions require time-sensitive responses and the video quality is less important. Note that each unicast client connecting to the server takes up additional bandwidth and the Network Camera allows up to ten simultaneous accesses.

UDP multicast: This protocol allows multicast-enabled routers to forward network packets to all clients requesting streaming media. This helps to reduce the network transmission load of the Network Camera while serving multiple clients at the same time. Note that to utilize this feature, the Network Camera must be configured to enable multicast streaming at the same time. For more information, please refer to RTSP Streaming on page 103.

TCP: This protocol guarantees the complete delivery of streaming data and thus provides better video quality. The downside of this protocol is that its real-time effect is not as good as that of the UDP protocol.

HTTP: This protocol allows the same quality as TCP protocol without needing to open specific ports for streaming under some network environments. Users inside a firewall can utilize this protocol to allow streaming data through.

MP4 Saving Options

MP4 saving options

Folder:

File name prefix:

Add date and time suffix to file name

Users can record live video as they are watching it by clicking  Start MP4 Recording on the main page. Here, you can specify the storage destination and file name.

Folder: Specify a storage destination on your PC for the recorded video files. The location can be changed.

File name prefix: Enter the text that will be appended to the front of the video file name. A specified folder will be automatically created on your local hard disk.

Add date and time suffix to the file name: Select this option to append the date and time to the end of the file name.

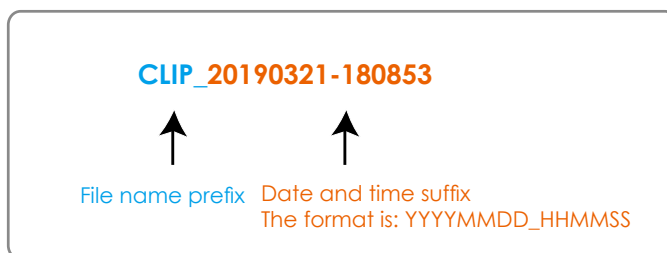

Local Streaming Buffer Time

Local streaming buffer time

Millisecond

In the case of encountering unsteady bandwidth, live streaming may lag and video streaming may not be very smoothly. If you enable this option, the live streaming will be stored temporarily on your PC's cache memory for a few milli seconds before being played on the live viewing window. This will help you see the streaming more smoothly. If you enter 3,000 Millisecond, the streaming will delay for 3 seconds.

Joystick settings

Enable Joystick

Connect a joystick to a USB port on your management computer. Supported by the plug-in (Microsoft's DirectX), once the plug-in for the web console is loaded, it will automatically detect if there is any joystick on the computer. The joystick should work properly without installing any other driver or software.

Then you can begin to configure the joystick settings of connected devices. Please follow the instructions below to enable joystick settings.

1. Select a detected joystick, if there are multiple, from the Selected joystick menu. If your joystick is not detected, it may be defective.
2. Click Calibrate or Configure buttons to configure the joystick-related settings.

Joystick settings

Selected joystick: Macally AirStick



NOTE:

- If you want to assign Preset actions to your joystick, the preset locations should be configured in advance in the **Configuration > PTZ** page. In Windows, use the search function on the Start menu to search for Game Controller.
- If your joystick is not working properly, it may need to be calibrated. Click the **Calibrate** button to open the Game Controllers window located in Microsoft Windows control panel and follow the instructions for trouble shooting.
- The joystick will appear in the **Game Controllers** list in the Windows Control panel. If you want to check out for your devices, go to the following page: Start -> Control Panel -> Game Controllers.



Buttons Configuration

In the Button Configuration window, the left column shows the actions you can assign, and the right column shows the functional buttons and assigned actions. The number of buttons may differ from different joysticks.

Please follow the steps below to configure your joystick buttons:

1. Choosing one of the actions and click **Assign** will pop up a dialog. Then you can assign this action to a button by pressing the joystick button or select it from the drop-down list.
For example: Assign **Home** (move to home position) to Button 1.

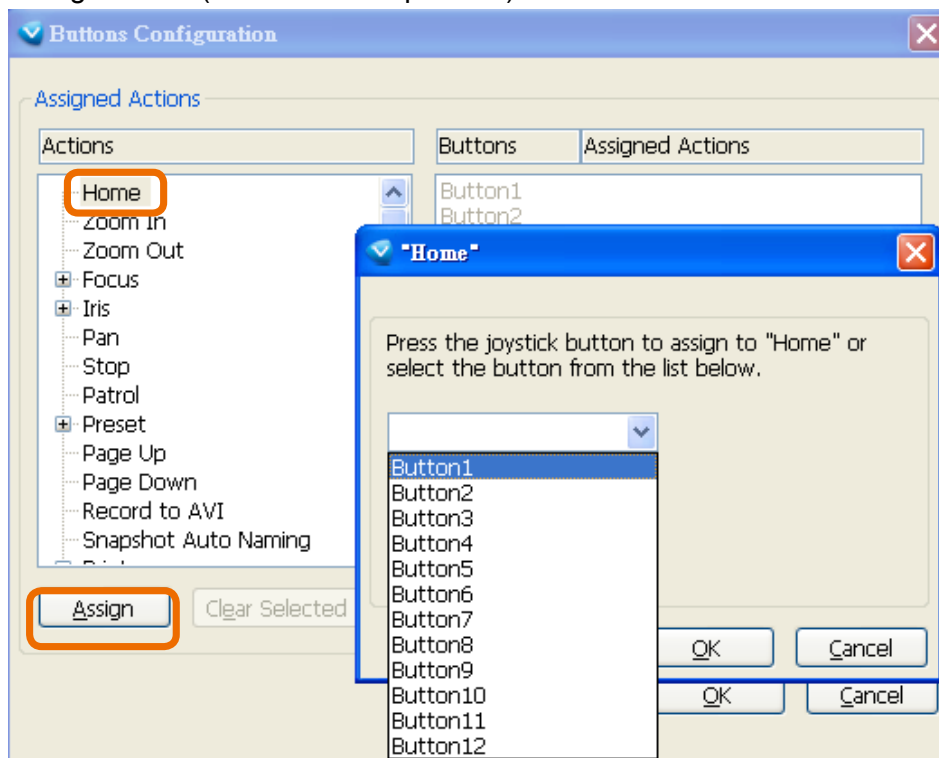

2. Click **OK** to confirm the configuration.

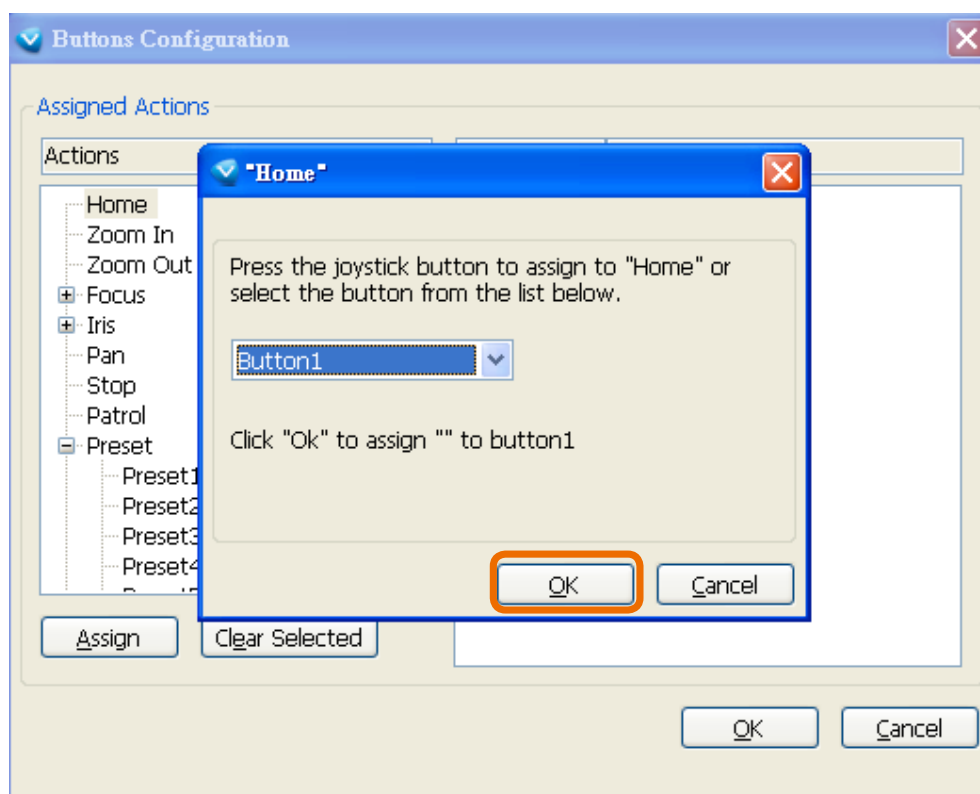

Buttons Configuration

Click the **Configure Buttons** button, a window will prompt as shown below. Please follow the steps below to configure your joystick buttons:

1. Select a button number from the Button # pull-down menu.

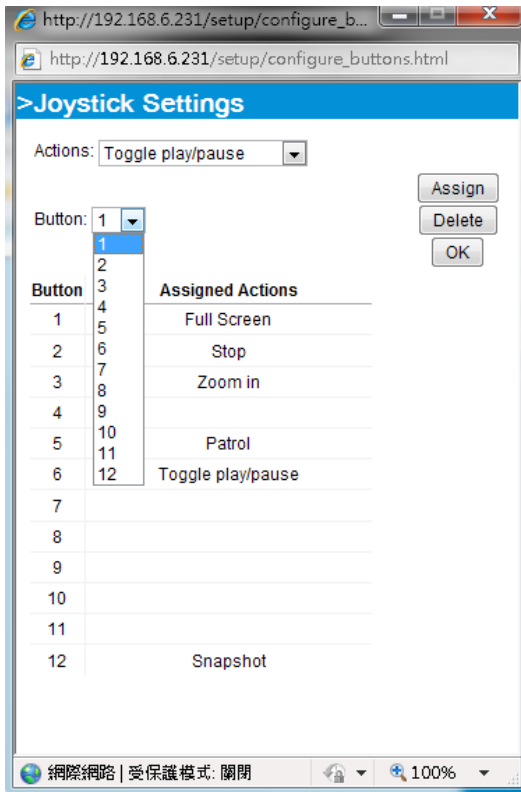

Tips:

If you are not sure of the locations of each button, use the **Properties** window in the **Game Controllers** utility.

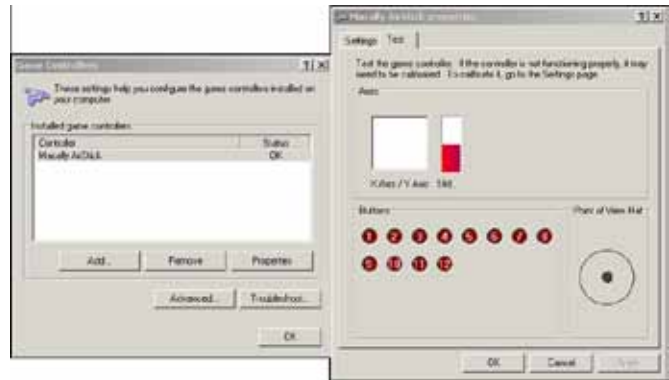

2. Select a corresponding action, such as Patrol or Preset#.

3. Click the **Assign** button to assign an action to the button. You can delete an association by selecting a button number, and then click the **Delete** button.

Repeat the process until you are done with the configuration of all preferred actions.

The buttons you define should appear on the button list accordingly.

4. Please remember to click the **Save** button on the Client settings page to preserve your settings.

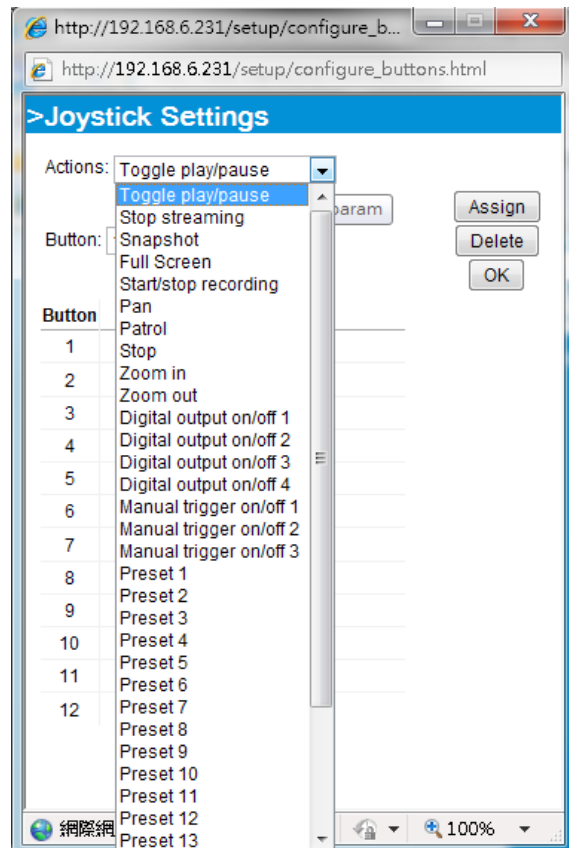

Configuration

Click **Configuration** on the main page to enter the camera setting pages. Note that only Administrators can access the configuration page.

VIVOTEK provides an easy-to-use user interface that helps you set up your network camera with minimal effort. In order to simplify the user interface, detailed information will be hidden unless you click on the function item. When you click on the first sub-item, the detailed information for the first sub-item will be displayed; when you click on the second sub-item, the detailed information for the second sub-item will be displayed and that of the first sub-item will be hidden.

The following is the interface of the main page:

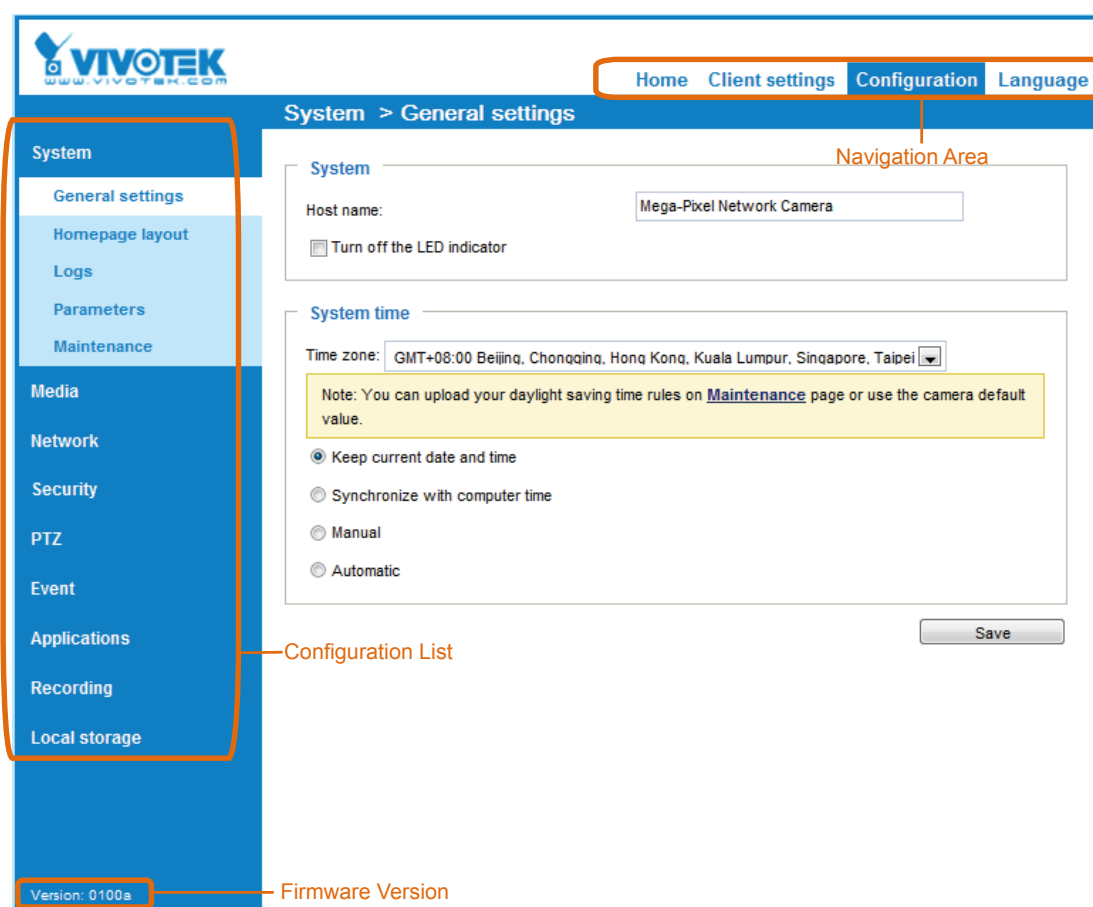

Each function on the configuration list will be explained in the following sections.

The Navigation Area provides access to all different views from the **Home** page (for live viewing), **Configuration** page, and multi-language selection.

System > General settings

This section explains how to configure the basic settings for the Network Camera, such as the host name and system time. It is composed of the following two columns: System, and System Time. When finished with the settings on this page, click **Save** at the bottom of the page to enable the settings.

System



The screenshot shows a settings panel titled "System". It contains two main elements: a text input field for the "Host name" which is currently set to "Mega-Pixel Network Camera", and a checkbox labeled "Turn off the LED indicator" which is currently unchecked.

Host name: Enter a desired name for the Network Camera. The text will be displayed at the top of the main page, and also on the view cells of the ST7501 and VAST management software.

Turn off the LED indicators: If you do not want others to notice the network camera is in operation, you can select this option to turn off the LED indicators.

System time

System time

Time zone: GMT+08:00 Beijing, Chongqing, Hong Kong, Kuala Lumpur, Singapore, Taipei

Note: You can upload your daylight saving time rules on [Maintenance](#) page or use the camera default value.

Keep current date and time
 Synchronize with computer time
 Manual
 Automatic

Keep current date and time: Select this option to preserve the current date and time of the Network Camera. The Network Camera's internal real-time clock maintains the date and time even when the power of the system is turned off.

Synchronize with computer time: Select this option to synchronize the date and time of the Network Camera with the local computer. The read-only date and time of the PC is displayed as updated.

Manual: The administrator can enter the date and time manually. Note that the date and time format are [yyyy/mm/dd] and [hh:mm:ss].

Automatic: The Network Time Protocol is a protocol which synchronizes computer clocks by periodically querying an NTP Server.

NTP server: Assign the IP address or domain name of the time-server. Leaving the text box blank connects the Network Camera to the default time servers. The precondition is that the camera must have the access to the Internet.

Update interval: Select to update the time using the NTP server on an hourly, daily, weekly, or monthly basis.

Time zone : Select the appropriate time zone from the list. If you want to upload Daylight Savings Time rules, please refer to **System > Maintenance > Import/ Export files** on page 67 for details.

System > Homepage layout

This section explains how to set up your own customized homepage layout.

General settings

This column shows the settings of your homepage layout. You can manually select the background and font colors in Theme Options (the second tab on this page). The settings will be displayed automatically in this Preview field. The following shows the homepage using the default settings:



- Hide Powered by VIVOTEK: If you check this item, it will be removed from the homepage.

Logo graph

Here you can change the logo that is placed at the top of your homepage.

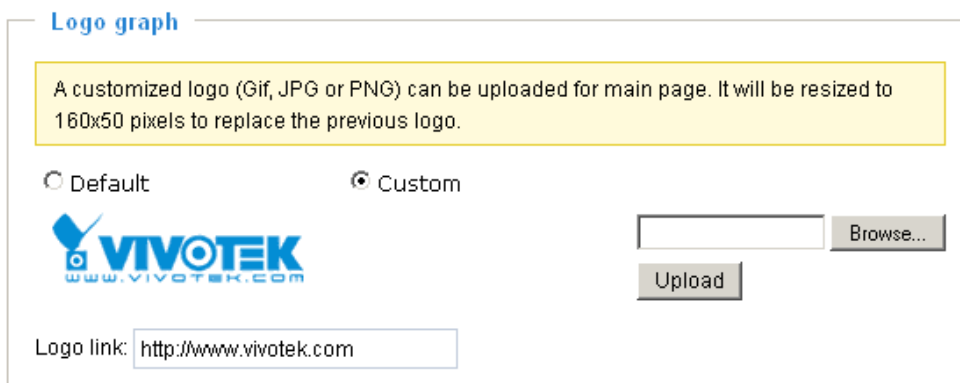

Follow the steps below to upload a new logo:

1. Click **Custom** and the Browse field will appear.
2. Select a logo from your files.
3. Click **Upload** to replace the existing logo with a new one.
4. Enter a website link if necessary.
5. Click **Save** to enable the settings.

Customized button

If you want to hide manual trigger buttons on the homepage, please uncheck this item. This item is checked by default.



Theme Options

Here you can change the color of your homepage layout. There are three types of preset patterns for you to choose from. The new layout will simultaneously appear in the **Preview** filed. Click **Save** to enable the settings.

General settings | Theme options

Font Color

Background Color of the Control Area

Font Color of the Configuration Area

Background Color of the Configuration Area

Preset patterns

Font Color of the Video Title

Background Color of the Video Area

Frame Color

Themes

Color

- Font color: #000000
- Font color of video title: #098BD6
- Bk color of control area: #C4EAFF
- Bk color of configuration area: #0186D1
- Bk color of video area: #C4EAFF
- Frame color: #0186D1

Save

General settings | Theme options

VIVOTEK
www.vivotek.com

Mega-Pixel Network

Video stream 1

Manual triggers:

Digital output: On Off

Powered by VIVOTEK

General settings | Theme options

VIVOTEK
www.vivotek.com

Mega-Pixel Network

Video stream 1

Manual triggers:

Digital output: On Off

Powered by VIVOTEK

■ Follow the steps below to set up the customized homepage:

1. Click **Custom** on the left column.
2. Click the field where you want to change the color on the right column.

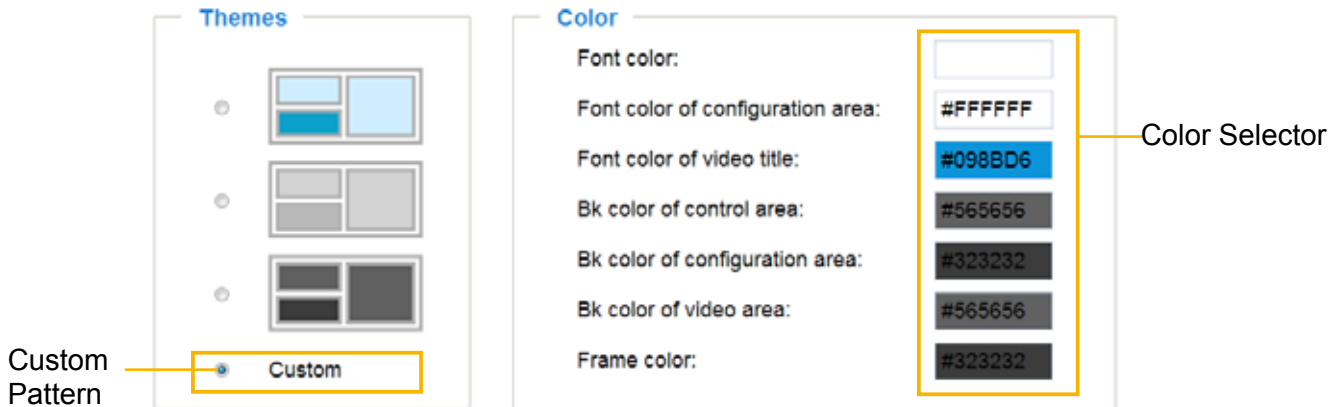

3. The palette window will pop up as shown below.

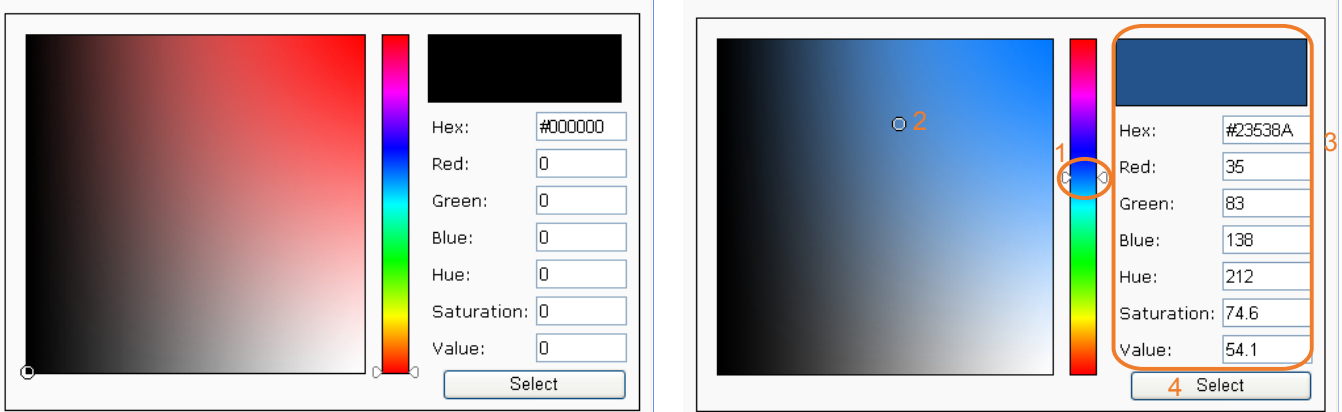

4. Drag the slider bar and click on the left square to select a desired color.
5. The selected color will be displayed in the corresponding fields and in the **Preview** column.
6. Click **Save** to enable the settings.

System > Logs

This section explains how to configure the Network Camera to send the system log to a remote server as backup.

Log server settings



Follow the steps below to set up the remote log:

1. Select **Enable remote log**.
2. In the IP address text box, enter the IP address of the remote server.
2. In the port text box, enter the port number of the remote server.
3. When completed, click **Save** to enable the setting.

You can configure the Network Camera to send the system log file to a remote server as a log backup. Before utilizing this feature, it is suggested that the user install a log-recording tool to receive system log messages from the Network Camera. An example is Kiwi Syslog Daemon. Visit <http://www.kiwisyslog.com/kiwi-syslog-daemon-overview/>.

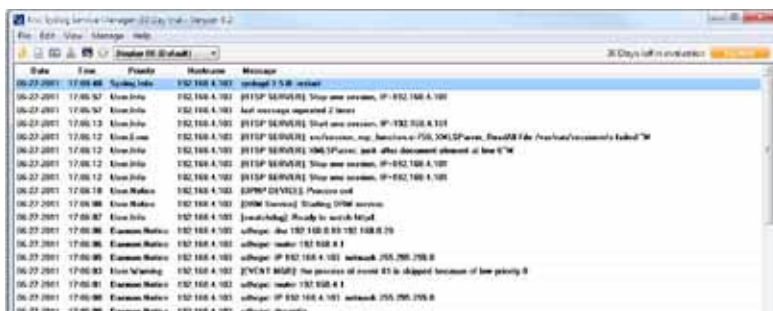

System log

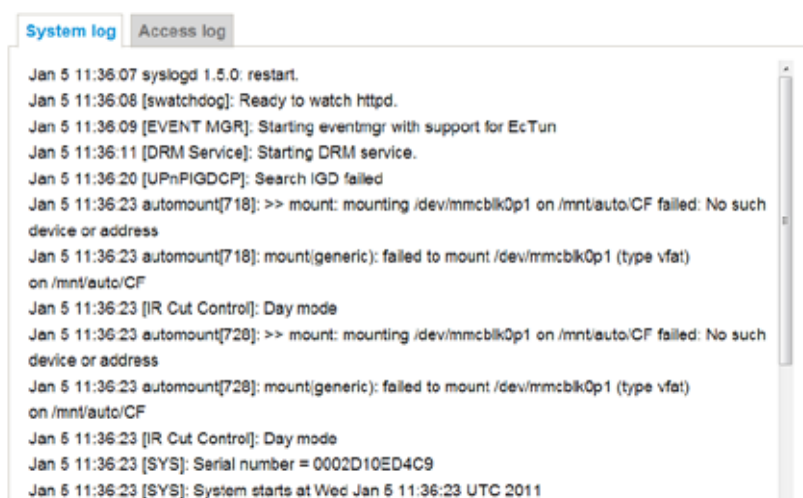

This column displays the system log in a chronological order. The system log is stored in the Network Camera's buffer area and will be overwritten when reaching a certain limit.

You can install the included VAST recording software, which provides an Event Management function group for delivering event messages via emails, GSM short messages, onscreen event panel, or to trigger an alarm, etc. For more information, refer to the VAST User Manual.

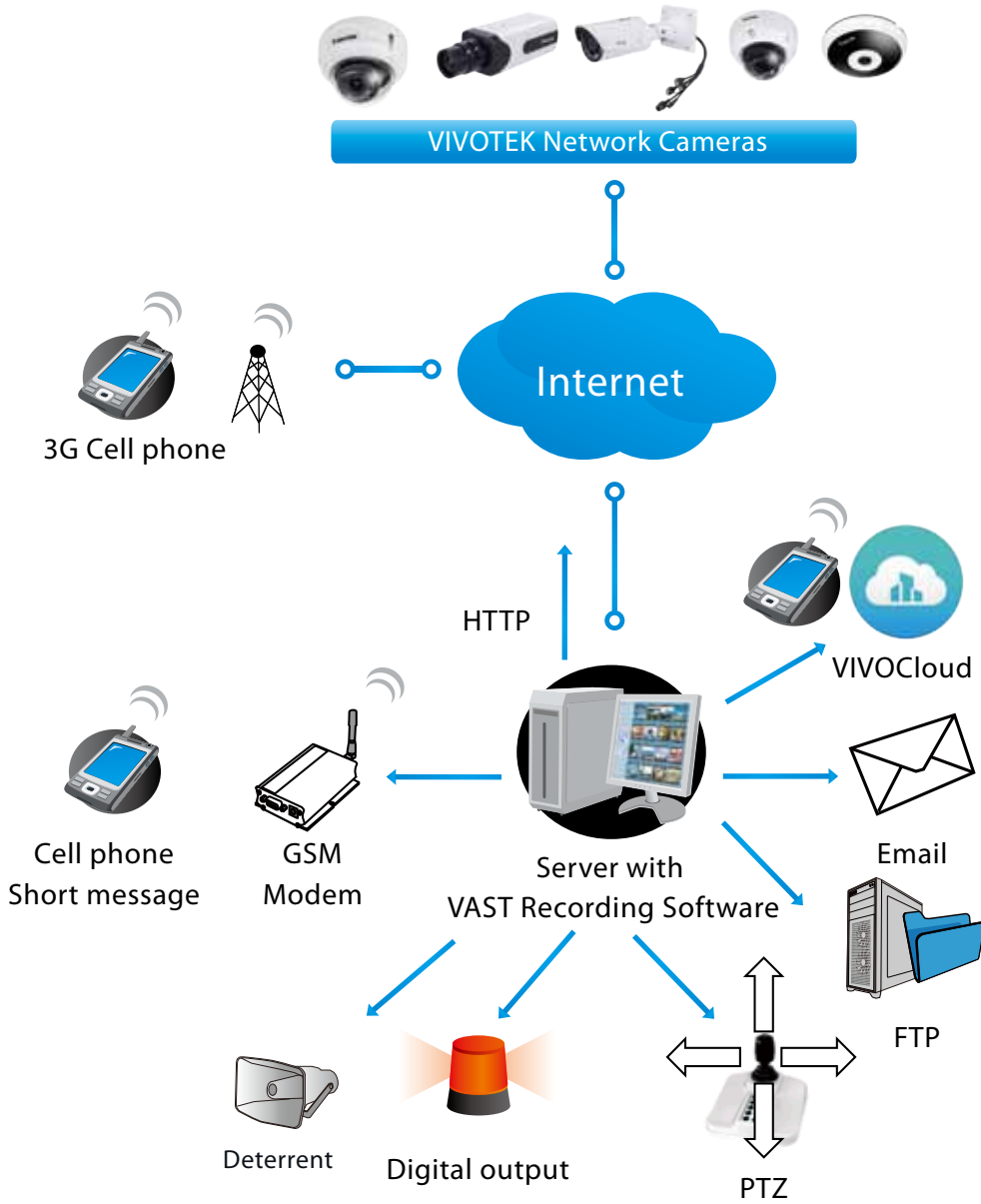

Access log

System log

Access log

```
Jan 5 11:36:28 [RTSP SERVER]: Start one session, IP=172.16.2.52
Jan 5 11:49:15 [RTSP SERVER]: Start one session, IP=192.168.4.105
Jan 5 13:11:20 [RTSP SERVER]: Start one session, IP=192.168.4.105
```

Access log displays the access time and IP address of all viewers (including operators and administrators) in a chronological order. The access log is stored in the Network Camera's buffer area and will be overwritten when reaching a certain limit.

System > Parameters

The View Parameters page lists the entire system's parameters. If you need technical assistance, please provide the information listed on this page.

Parameters

```
system_hostname='FD9389-HV'
system_ledoff='0'
system_lowlight='1'
system_date='2019/05/02'
system_time='12:58:53'
system_datetime=''
system_ntp=''
system_timezoneindex='320'
system_daylight_enable='0'
system_daylight_dstactualmode='1'
system_daylight_auto_begintime='NONE'
system_daylight_auto_endtime='NONE'
system_daylight_timezones=',-360,-320,-280,-240,-241,-200,-201,-160'
system_updateinterval='0'
system_info_modelname='FD9389-HV'
system_info_extendedmodelname='FD9389-HV'
system_info_serialnumber='0002D17DEE5A'
system_info_firmwareversion='FD9389-VVTK-0113d'
system_info_language_count='10'
system_info_language_i0='English'
system_info_language_i1='Deutsch'
system_info_language_i2='Español'
system_info_language_i3='Français'
system_info_language_i4='Italiano'
system_info_language_i5='日本語'
system_info_language_i6='Português'
system_info_language_i7='简体中文'
system_info_language_i8='繁體中文'
system_info_language_i9='Русский'
system_info_language_i10=''
system_info_language_i11=''
```

System > Maintenance

This chapter explains how to restore the Network Camera to factory default, upgrade firmware version, etc.

General settings > Upgrade firmware

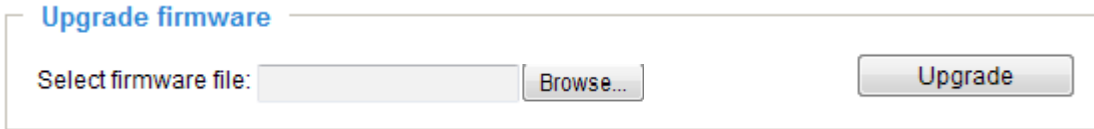

Upgrade firmware

Select firmware file:

This feature allows you to upgrade the firmware of your Network Camera. It takes a few minutes to complete the process.

Note: Do not power off the Network Camera during the upgrade!

Follow the steps below to upgrade the firmware:

1. Download the latest firmware file from the VIVOTEK website. The file is in .pkg file format.
2. Click **Browse...** and locate the firmware file.
3. Click **Upgrade**. The Network Camera starts to upgrade and will reboot automatically when the upgrade completes.

If the upgrade is successful, you will see “Reboot system now!! This connection will close”. After that, re-access the Network Camera.

The following message is displayed when the upgrade has succeeded.

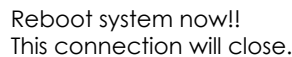

Reboot system now!!
This connection will close.

The following message is displayed when you have selected an incorrect firmware file.

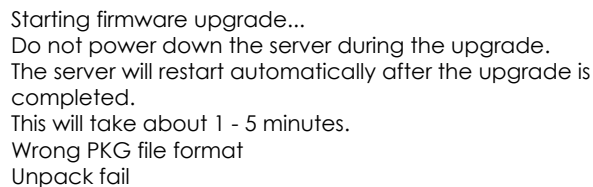

Starting firmware upgrade...
Do not power down the server during the upgrade.
The server will restart automatically after the upgrade is completed.
This will take about 1 - 5 minutes.
Wrong PKG file format
Unpack fail

General settings > Reboot

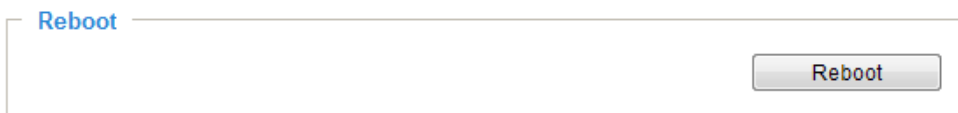

Reboot

This feature allows you to reboot the Network Camera, which takes about one minute to complete. When completed, the live video page will be displayed in your browser. The following message will be displayed during the reboot process.

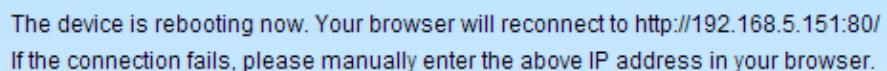

The device is rebooting now. Your browser will reconnect to <http://192.168.5.151:80/>
If the connection fails, please manually enter the above IP address in your browser.

If the connection fails after rebooting, manually enter the IP address of the Network Camera in the address field to resume the connection.

General settings > Restore

Restore

Restore all settings to factory default except settings in

Network Daylight saving time Custom language VADP Focus position

Restore

This feature allows you to restore the Network Camera to factory default settings.

Network: Select this option to retain the Network Type settings (please refer to Network Type on page 96).

Daylight Saving Time: Select this option to retain the Daylight Saving Time settings (please refer to Import/Export files below on this page).

Custom Language: Select this option to retain the Custom Language settings.

VADP: Retain the VADP modules (3rd-party software stored on the SD card) and related settings.

Focus position: Retain the lens focus position using the previously saved position parameters.

If none of the options is selected, all settings will be restored to factory default. The following message is displayed during the restoring process.

The device is rebooting now. Your browser will reconnect to <http://192.168.5.151:80/>
If the connection fails, please manually enter the above IP address in your browser.



Import/Export files

This feature allows you to Export / Update daylight saving time rules, custom language file, configuration file, and server status report.

General settings
Import/Export files

Export files

Export daylight saving time configuration file	<input type="button" value="Export"/>
Export language file	<input type="button" value="Export"/>
Export configuration file	<input type="button" value="Export"/>
Export server status report	<input type="button" value="Export"/>

Upload files

Update daylight saving time rules:	<input type="text"/>	<input type="button" value="Browse..."/>	<input type="button" value="Upload"/>
Update custom language file:	<input type="text"/>	<input type="button" value="Browse..."/>	<input type="button" value="Upload"/>
Upload configuration file:	<input type="text"/>	<input type="button" value="Browse..."/>	<input type="button" value="Upload"/>

Export daylight saving time configuration file: Click to set the start and end time of DST (Daylight Saving).

Follow the steps below to export:

1. In the Export files column, click **Export** to export the daylight saving time configuration file from the Network Camera.
2. A file download dialog will pop up as shown below. Click **Open** to review the XML file or click **Save** to store the file for editing.

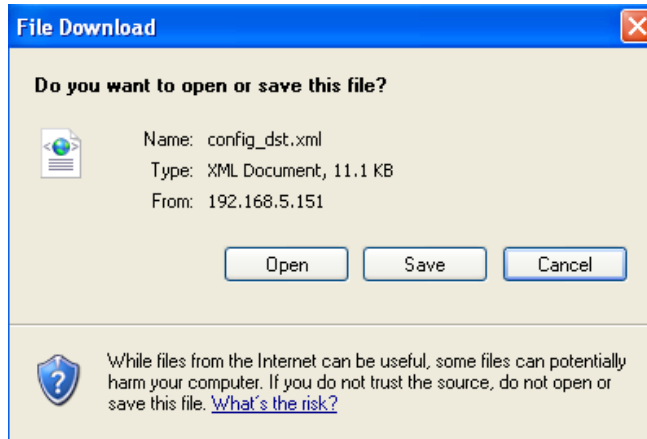

- Open the file with Microsoft® Notepad and locate your time zone; set the start and end time of DST. When completed, save the file.

In the example below, DST begins each year at 2:00 a.m. on the second Sunday in March and ends at 2:00 a.m. on the first Sunday in November.

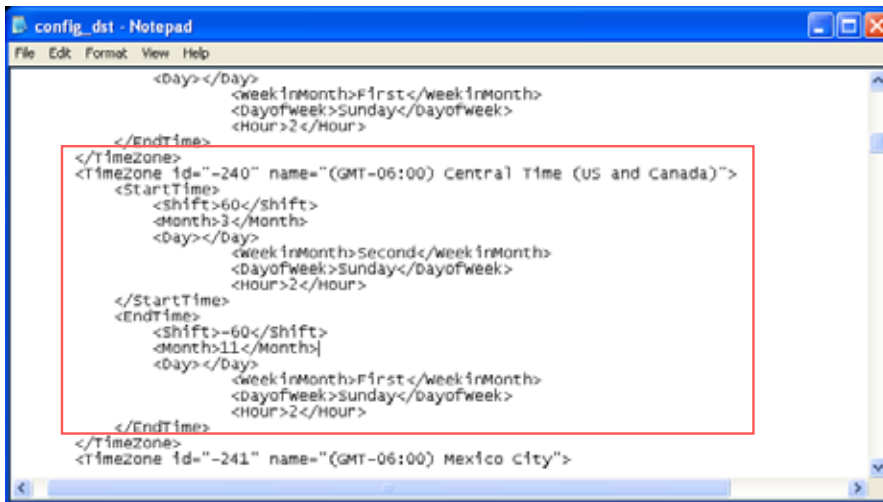

Update daylight saving time rules: Click **Browse...** and specify the XML file to update.

If the incorrect date and time are assigned, you will see the following warning message when uploading the file to the Network Camera.

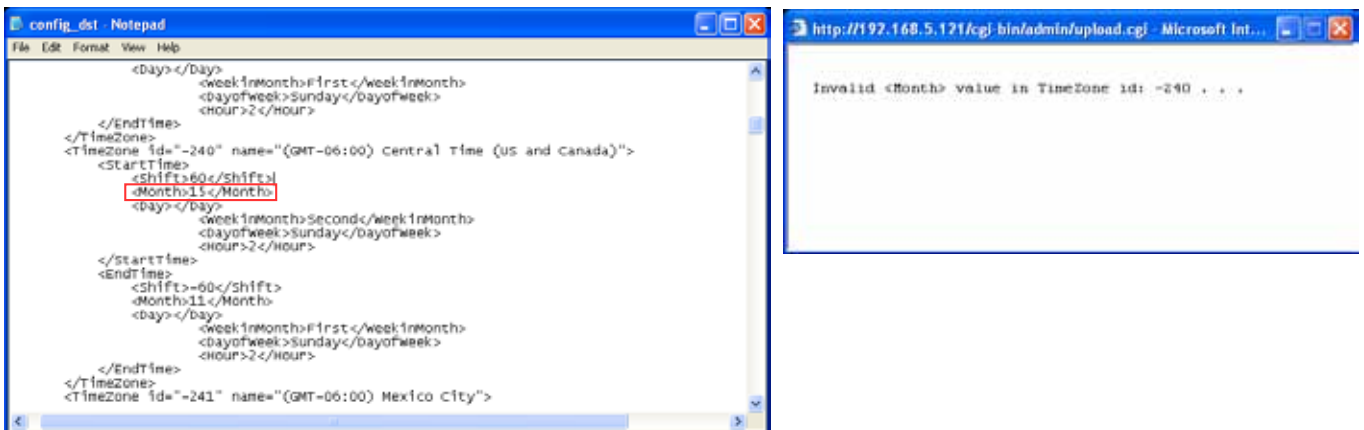

The following message is displayed when attempting to upload an incorrect file format.

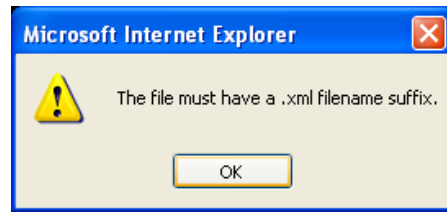

Export language file: Click to export language strings. VIVOTEK provides nine languages: English, Deutsch, Español, Français, Italiano, 日本語, Português, 簡體中文, and 繁體中文.

Update custom language file: Click **Browse...** and specify your own custom language file to upload.

Export configuration file: Click to export all parameters for the device and user-defined scripts.

Update configuration file: Click **Browse...** to update a configuration file. Please note that the model and firmware version of the device should be the same as the configuration file. If you have set up a fixed IP or other special settings for your device, it is not suggested to update a configuration file.

Export server status report: Click to export the current server status report, such as time, logs, parameters, process status, memory status, file system status, network status, kernel message ... and so on.

Tips:

- If a firmware upgrade is accidentally disrupted, say, by a power outage, you still have a last resort method to restore normal operation. See the following for how to bring the camera back to work:

Applicable scenario:

- (a) Power disconnected during firmware upgrade.
- (b) Unknown reason causing abnormal LED status, and a Restore cannot recover normal working condition.

You can use the following methods to activate the camera with its backup firmware:

- (a) Press and hold down the reset button for at least one minute.
- (b) Power on the camera until the Red LED blinks rapidly.
- (c) After boot up, the firmware should return to the previous version before the camera hanged. (The procedure should take 5 to 10 minutes, longer than the normal boot-up process). When this process is completed, the LED status should return to normal.

Media > Image

This section explains how to configure the image settings of the Network Camera. It is composed of the following columns: General settings, IR control, Image settings, Exposure, Focus, and Privacy mask. The Focus window is available only for models that come with motorized lens.

General settings

The screenshot shows the 'General settings' tab selected. Under the 'Video settings' section, the following options are visible:

- Video title: [Empty text box]
- Show timestamp and video title in video and snapshots
- Position of timestamp and video title on image: [Top] (dropdown)
- Timestamp and video title font-size: [30] (dropdown)
- Video font (.ttf): [Default] (dropdown) [Upload]
- Color: B/W Color
- Power line frequency: 50 Hz 60 Hz
- Video orientation: Flip Mirror Rotate

Video title

Show timestamp and video title in video and snapshots: Enter a name that will be displayed on the title bar of the live video as the picture shown below. A zoom indicator will be displayed on the Home page when you zoom in/out on the live viewing window as shown below. You may zoom in/out on the image by scrolling the mouse wheel inside the live viewing window, and the maximum zoom in will be up to 12 times.

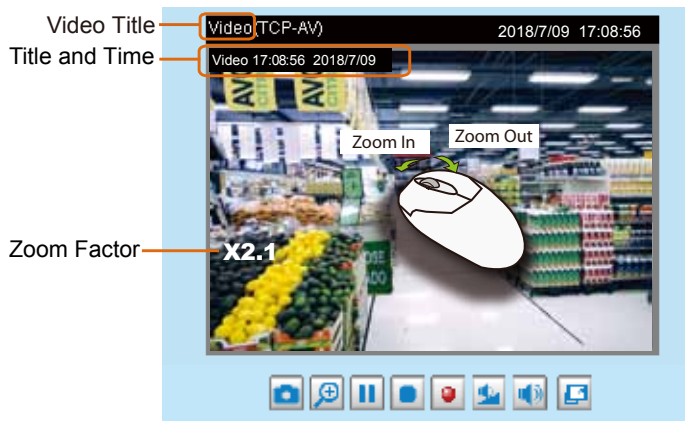

Position of timestamp and video title on image: Select to display time stamp and video title on the top or at the bottom of the video stream.

Timestamp and video title font size: Select the font size for the time stamp and title.

Video font (.ttf): You can select a True Type font file for the display of textual messages on video.

Color: Select to display color or black/white video streams.

Power line frequency: Set the power line frequency consistent with local utility settings to eliminate image flickering associated with fluorescent lights. Note that after the power line frequency is changed, you must disconnect and reconnect the power cord of the Network Camera in order for the new setting to take effect.

Video orientation: Flip - vertically reflect the display of the live video; Mirror - horizontally reflect the display of the live video. Select both options if the Network Camera is installed upside-down (e.g., on the ceiling) to correct the image orientation. Please note that if you have preset locations, those locations will be cleared after flip/mirror setting.

Rotate -

Rotate Degrees

The rotation here indicates clockwise rotation. Rotation can be applied with flip, mirror, and physical lens rotation (see below) settings to adapt to different mounting locations.

The figures in the illustration are shown in a consecutive order.

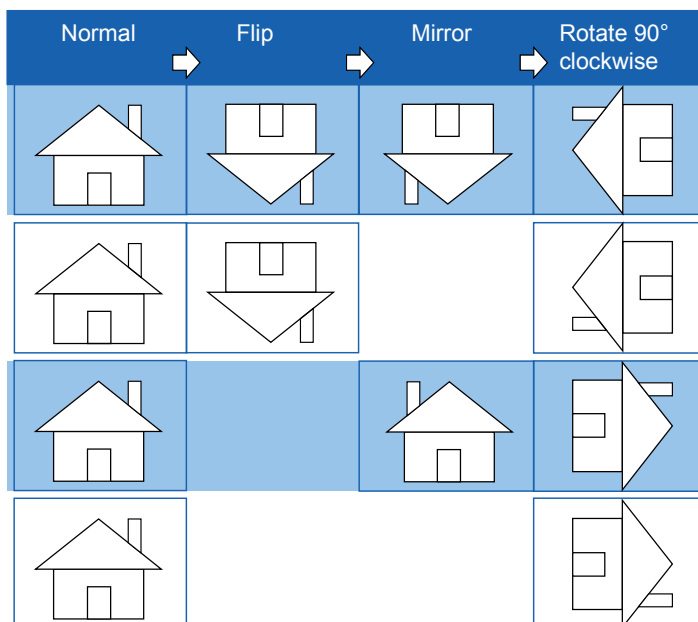

The camera may be installed on a vertical, side-facing, or tilted surface in order to accommodate the interior or exterior design of a building. The interior of a building can be shaped as a narrow rectangular space, such as a corridor. The conventional HD image, such as that of a 16:9 aspect ratio, will be incongruous with its wide horizontal view. With video rotation, the camera can more readily cover the field of view on a tall and narrow scene.

Day/Night Settings

Day/Night settings

Switch to B/W in night mode

IR cut filter:

Light sensor sensitivity:

Switch to B/W in night mode

Select this to enable the Network Camera to automatically switch to Black/White during night mode.

IR cut filter

With a removable IR-cut filter, this Network Camera can automatically remove the filter to let Infrared light pass into the sensor during low light conditions.

- Auto mode (The **Day/Night Exposure Profile** will not be available if Auto mode is selected)
The Network Camera automatically removes the filter by judging the level of ambient light.
- Day mode
In day mode, the Network Camera switches on the IR cut filter at all times to block infrared light from reaching the sensor so that the colors will not be distorted.
- Night mode
In night mode, the Network Camera switches off the IR cut filter at all times for the sensor to accept infrared light, thus helping to improve low light sensitivity.
- Synchronize with digital input
If an external IR device is connected that comes with its own light sensor, you can use a digital input from it to trigger the IR cut filter. Doing so can synchronize the detection of light level between the camera and the external IR device.
- Schedule mode
The Network Camera switches between day mode and night mode based on a specified schedule. Enter the start and end time for day mode. Note that the time format is [hh:mm] and is expressed in 24-hour clock time. By default, the start and end time of day mode are set to 07:00 and 18:00.

Light sensor sensitivity

Tune the responsiveness of the IR filter to lighting conditions as Low, Normal, or High.

When completed with the settings on this page, click **Save** to enable the settings.

IR control

Turn on built-in IR illuminator in night mode

Select this to turn on the camera's onboard IR illuminator when the camera detects low light condition and enters the night mode.

Image settings

On this page, you can tune the White balance and Image adjustment.

Sensor Setting 2:
For special situations

Sensor Setting 1:
For normal situations



White balance: Adjust the value for the best color temperature.

■ You may follow the steps below to adjust the white balance to the best color temperature.

1. Place a sheet of paper of white or cooler-color temperature color, such as blue, in front of the lens, then allow the Network Camera to automatically adjust the color temperature.
2. Click the **On** button to **Fix current value** and confirm the setting while the white balance is being measured.

■ You may also manually tune the color temperature by pulling the RGain and BGain slide bars.

Image Adjustment

■ **Brightness**: Adjust the image brightness level, which ranges from 0% to 100%.

■ **Contrast**: Adjust the image contrast level, which ranges from 0% to 100%.

■ **Saturation**: Adjust the image saturation level, which ranges from 0% to 100%.

■ **Sharpness**: Adjust the image sharpness level, which ranges from 0% to 100%.

■ **Gamma curve**: Adjust the image sharpness level, which ranges from 0.45 to 1, from Detailed to Contrast. You may let firmware **Optimize** your display or select the **Manual** mode, and pull the slide bar pointer to change the preferred level of Gamma correction towards higher contrast or towards the higher luminance for detailed expression for both dark and lighted areas of an image.

This option is disabled when the WDR feature is enabled.

Defog: Defog helps improve the visibility quality of captured image in poor weather conditions such as smog, fog, or smoke.

Highlight mask

- Strong light sources will be masked from the scene, and the image contrast will be strengthened. This function is useful to prevent the spot-light effects in a high dynamic scene.

False color may be observed around the edges of strong light sources.

Noise reduction

- Enable noise reduction: Check to enable noise reduction in order to reduce noises and flickers in image. This applies to the onboard 3D Noise Reduction feature. Use the slide bar to adjust the reduction strength. Note that applying this function to the video channel will consume system computing power.

3D Noise Reduction is mostly applied in low-light conditions. When enabled in a low-light condition with fast moving objects, trails of after-images may occur. You may then select a lower strength level or disable the function.

Scene mode: deblur

- When enabled, shutter time will be fixed to 1/120 second to reduce image smear. This feature is designed to apply with human movement at the pace of 1.4~2.2m/s. The deblur function is related to Motion detection where motion-alerted pixels need to be suppressed in order to increase the accuracy of motion detection. In certain conditions, shadows or light changes can all cause false alarms in motion detection.

The deblur function uses the same detection window as that of the Motion detection.

Note that the **Preview** button has been cancelled, all changes made to image settings is directly shown on screen. You can click **Restore** to recall the original settings without incorporating the changes. When completed with the settings on this page, click **Save** to enable the setting. You can also click on **Profile mode** to adjust all settings above in a tabbed window for special lighting conditions.

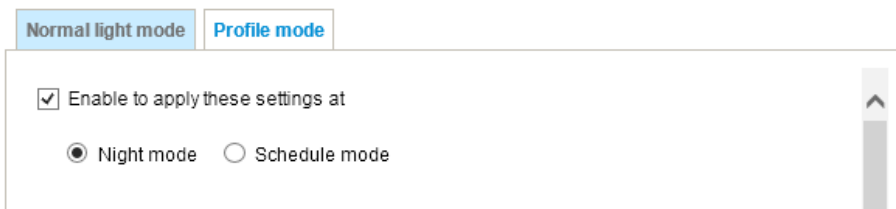

Enable to apply these settings at: Select the mode this profile to apply to: Day mode, Night mode, or Schedule mode. Please manually enter a range of time if you choose the Schedule mode. Then check **Save** to take effect.

Enable digital image stabilizer

If you experience problems such as vibration occurs when on a pole mount, try enable the image stabilizer.

Exposure

On this page, you can set the Exposure measurement window, Exposure level, Exposure mode, Exposure time, Gain control, and Day/Night mode settings. You can configure two sets of Exposure settings: one for normal situations, the other for special situations, such as the day/night/schedule mode.

Sensor Setting 2:
For special situations

Sensor Setting 1:
For normal situations

Exposure strategy:

Measurement window: This function allows users to set measurement window(s) for low light compensation. For example, where low-light objects are posed against an extremely bright background. You may want to exclude the bright sunlight shining through a building's corridor.

- Full view: Calculate the full range of view and offer appropriate light compensation.
- Custom: This option allows you to manually add customized windows as inclusive or exclusive regions. A total of 10 windows can be configured. Please refer to the next page for detailed illustration.

The inclusive window refers to the “weighted window”; the exclusive window refers to “ignored window”. It adopts the weighted averages method to calculate the value. The inclusive windows have a higher priority. You can overlap these windows, and, if you place an exclusive window within a larger inclusive window, the exclusive part of the overlapped windows will be deducted from the inclusive window. An exposure value will then be calculated out of the remaining of the inclusive window.

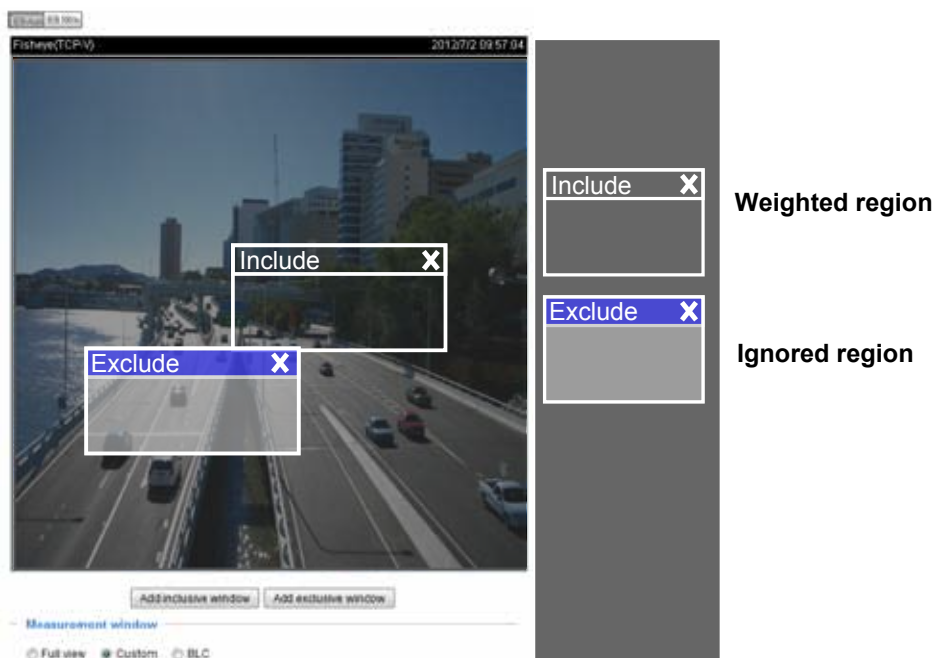

- **Center:** Use the center portion of the screen to determine the exposure level.

Metering mode:

- **Auto:** Firmware automatically determines an optimal exposure level.
- **BLC** (Back Light Compensation): This option will automatically add a “weighted region” in the middle of the window and give the necessary light compensation.
- **HLC:** (Highlight Compensation). Firmware detects strong light sources and compensates on affected spots to enhance the overall image quality. For example, the HLC helps reduce the glares produced by spotlights or headlights.

Exposure control:

- **Exposure level:** You can manually set the Exposure level, which ranges from -2.0 to +2.0 (dark to bright). You can click and drag the semi-circular pointers on the **Exposure time** and **Gain control** slide bars to specify a range of shutter time and Gain control values within which the camera can automatically tune to an optimal imaging result. You may prefer a shorter shutter time to better capture moving objects, while a faster shutter reduces light and needs to be compensated by electrical brightness gains.
- **Exposure mode:** (available when WDR Pro is disabled)
You can click and drag the semi-circular pointers on the **Exposure time** and **Gain control** slide bars to specify a range of shutter time and Gain control values within which the camera can automatically tune to an optimal imaging result. You can also configure the iris size to control the amount of light. For example, you may prefer a shorter shutter time to better capture moving objects, while a faster shutter reduces light and needs to be compensated by electrical brightness gains.
- **Flickerless:** Under some circumstances when there is a difference between the video capture frequency and local AC power frequency (NTSC or PAL), the mismatch causes color shifts or flickering images. If the above mismatch occurs, select the **Flickerless** checkbox, and the range of Exposure time (the shutter time) will be limited to a range in order to match the AC power frequency. When selected, the exposure time will be forced to stay longer than 1/120 second. For cameras that come with fixed iris lens, setting the exposure time to longer than 1/120 second may introduce too much lights to the lens. Users can use this option to observe whether the result of long exposure time is satisfactory.

Auto: If you set Exposure mode as **Auto**, the Exposure time and Gain control will not be configurable since the sensor library will automatically adjust the value according to the ambient light. Then you can configure iris mode as “indoor” or “outdoor” to reach the best image quality.

- **Iris mode:** Select Indoor or Outdoor iris mode to adapt to the installation. The preset iris aperture setting will apply.

■ **AE Speed Adjustment:**

This function applies when you need to monitor fast changing lighting conditions. For example, the camera may need to monitor a highway lane or entrance of a parking area at night where cars passing by with their lights on can bring fast changes in light levels. The same applies if the camera is installed on a vehicle, and when it needs to adapt to fast changes of light when entering and leaving a tunnel.

■ **WDR Pro:**

This refers to the Wide Dynamic Range function that enables the camera to capture details in a high contrast environment. Use the checkbox to enable the function, and use the slide bar to select the strength of the WDR Pro functionality, depending on the lighting condition at the installation site. You can select a higher effect when the contrast is high (between the shaded area and the light behind the objects).

Enable WDR enhanced: This function allows users to identify more image details with an extreme contrast from an object of interest with one shadowed side against a bright background, e.g., an entrance. You may select the **Enable WDR enhanced** checkbox, and then adjust the strength (low, medium, high) to reach the best image quality.

You can click **Restore** to recall the original settings without incorporating the changes. When completed with the settings on this page, click **Save** to enable the settings.

If you want to configure another sensor setting for day/night/schedule mode, please click **Profile** to open the Profile of exposure settings page as shown below.

Activated period: Select the mode this profile to apply to: Day mode, Night mode, or Schedule mode. Please manually enter a range of time if you choose Schedule mode. Then check **Save** to take effect.

Please follow the steps below to set up a profile:

1. Select the **Profile mode** tab.
2. Select the applicable mode: Night mode or Schedule mode. Please manually enter a range of time if you choose the Schedule mode.
3. Configure Exposure control settings in the following columns. Please refer to previous discussions for detailed information.
4. Click **Save** to enable the setting and click **Close** to exit the page.



Focus

Focus here refers to the **Remote Focus**, applicable to Network Cameras that are equipped with a stepping motor lens. The automated focus adjustment function eliminates the needs to physically adjust camera focus. In an outdoor deployment consisting of a large number of cameras, the auto focus function can be very helpful when these cameras become out of focus after days or weeks of operation. And that can easily result from the effects of natural forces, e.g., shrink and expand due to a wide range of operating temperatures and the vibration caused by wind.



Below is the procedure to perform the automated Focus function:

1. Select from the bottom of the screen whether you want to perform focus adjustment on the **Full view** or within a **Custom** focus window. You can create a custom window and click and drag the window to a desired position on screen.
2. It is recommended to **Reset** to the default back focus position of the sensor board.
3. You can use the **Fully-opened iris** checkbox (default) to increase the iris size for a better focus adjustment result.
4. Click to select the **Fully-opened iris** or the **Full-range scan** buttons. When a full-range scan is selected, a full-range scan through the camera's entire focal length can take about 30 to 80 seconds. If not, the auto focus scan will only go through the length where optimal focus may occur, and that takes about 15 to 20 seconds. In theory, best results of the auto scan can be acquired when the camera's iris is fully open.

5. Wait for the scan to complete. After a short while, the clearest image obtained should be displayed and the optimal focus range achieved. Use the arrow marks on the sides to fine-tune the focus if you are not satisfied with the results. You may still need to use the arrow marks to fine-tune the focus depending on the live image on your screen. ">" means moving from wide to tele end; and "<" tele to wide.

The methodology of using the Resize Buttons at the upper left corner of the streaming window is the same as that on the home page.

Focus window:

By default, the optimal focus is found on a full view window. You may designate a custom window within your current field of view to acquire the best focus out of it. However, you can not place a focus window on a distant background, e.g., a hall way that stretches away for 3 meters or farther. Doing so you will not benefit from the Focus window function.

- **Full view:** The focus tuning takes place by referring to the full view.
- **Custom:** You can create a focus window and drag it to a place of interest in your view window. Note that it is recommended to use this function only when you have a solid object in your view window that is showing a consistent color or texture. This function will not take effect if you set the focus window on a distant background.

Privacy mask

Click **Privacy Mask** to open the settings page. On this page, you can block out sensitive zones to address privacy concerns.

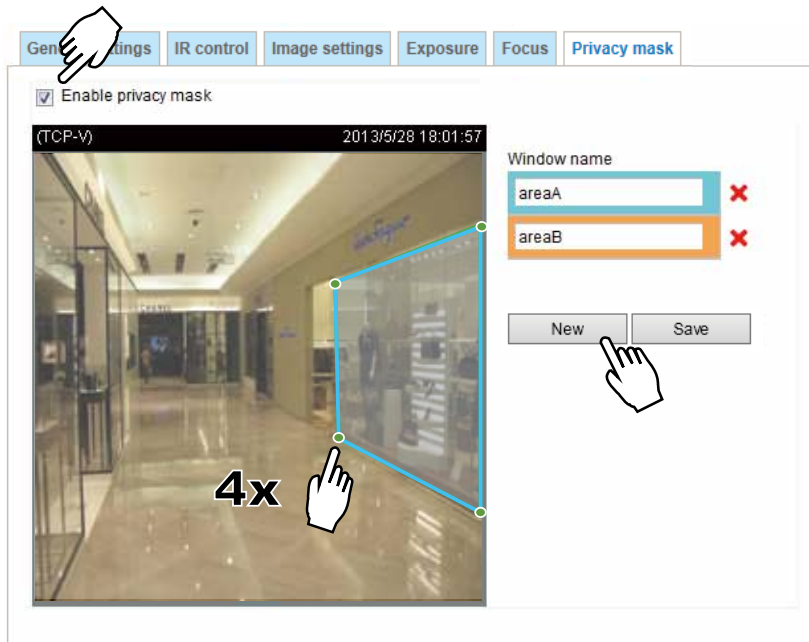

- To configure privacy mask windows,
 1. Click **New** to add a new window.
 2. You can use 4 mouse clicks to create a new masking window, which is recommended to be at least twice the size of the object (height and width) you want to cover.
 3. Enter a Window Name and click **Save** to enable the setting.
 4. Click on the **Enable privacy mask** checkbox to enable this function.



NOTE:

- ▶ *Up to 5 privacy mask windows can be configured on the same screen.*
- ▶ *If you want to delete the privacy mask window, please click the 'x' mark on the side of window name.*

Media > Video

Mode

The screenshot shows a user interface for selecting video modes. At the top, there are two tabs: 'Mode' and 'Stream'. The 'Mode' tab is active. Below the tabs, there is a list of three radio button options:

- 5-Megapixel (4:3) (MAX 30fps)
- 4-Megapixel (16:9) (MAX 30fps)
- 1080P FULL HD (16:9) (MAX 60fps)

The applicable video modes include:

- **5MP (4:3) (max. 30fps)**: This is the full resolution at 5 megapixels in a 4:3 screen aspect ratio.
- **4MP (16:9) (max. 30fps)**: At the 16:9 aspect ratio, the usable resolution is slightly reduced to 4MP.
- **1080P Full HD (16:9) (max. 60fps)**: If the need should arise for monitoring fast vehicles at 60fps, select this mode with a compromised resolution.

Media > Video

Stream settings

Mode
Stream

- ▶ Video settings for stream 1 [Viewing Window](#)
- ▶ Video settings for stream 2 [Viewing Window](#)
- ▶ Video settings for stream 3

This Network Camera supports multiple streams with frame sizes ranging from 480 x 352 to 2560 x 1920 pixels

The definition of multiple streams:

- Stream 1: Users can define the "Region of Interest" (viewing region) and the "Output Frame Size" (size of the live view window).
- Stream 2: The default frame size for Stream 2 is set to the 640 x 480.
- Stream 3: The default frame size for Stream 3 is set to the 2560 x 1920.

Click **Viewing Window** to open the viewing region settings page. On this page, you can configure the **Region of Interest** and the **Output Frame Size** for a video stream. For example, you can crop only a portion of the image that is of your interest, and thus save the bandwidth needed to transmit the video stream. As the picture shown below, the area of your interest in a parking lot should be the vehicles. The blue sky is of little value for the surveillance purpose.





Please follow the steps below to set up those settings for a stream:

1. Select a stream for which you want to set up the viewing region.
2. Select a **Region of Interest** from the drop-down list. The floating frame, the same as the one in the Global View window on the home page, will resize accordingly. If you want to set up a customized viewing region, you can also resize and drag the floating frame to a desired position with your mouse.
3. Choose a proper **Output Frame Size** from the drop-down list according to the size of your monitoring device.

NOTE:

► All the items in the “Region of Interest” should not be larger than the “Output Frame Size” (current maximum resolution).

■ The parameters of the multiple streams:

	Region of Interest	Output frame size
Stream 1	2560 x 1920 ~ 480 x 352 (Selectable)	2560 x 1920 ~ 480 x 352 (Selectable)
Stream 2	2560 x 1920 ~ 480 x 352 (Selectable)	2560 x 1920 ~ 480 x 352 (Selectable)
Stream 3	Fixed	Fixed

When completed with the settings in the Viewing Window, click **Save** to enable the settings and click **Close** to exit the window. The selected **Output Frame Size** will immediately be applied to the **Frame size** of each video stream. Then you can go back to the home page to test the e-PTZ function. For more information about the e-PTZ function, please refer to page 128.

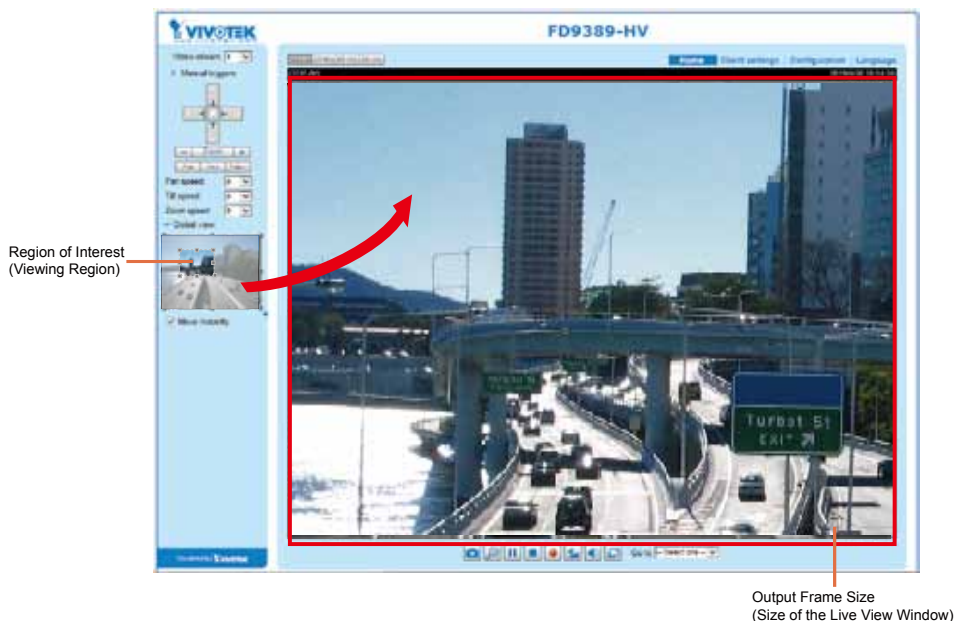

Click the stream item to display the detailed information. The maximum frame size will follow your settings in the above Viewing Window sections.

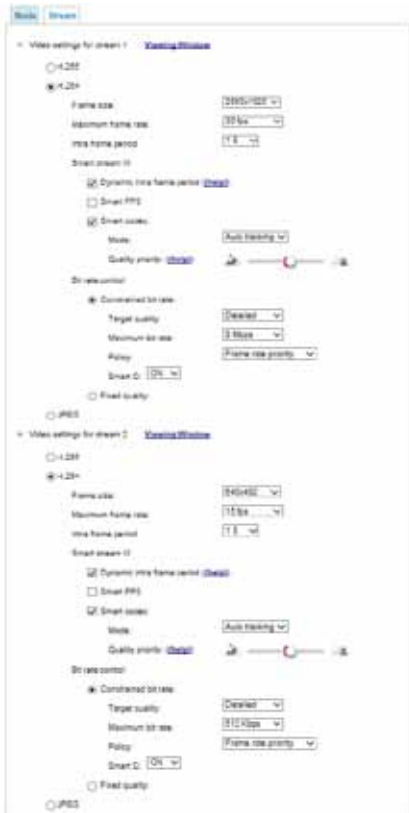

This Network Camera provides real-time H.265, H.264 and MJPEG compression standards (Triple Codec) for real-time viewing. If the **H.265** or **H.264** mode is selected, the video is streamed via RTSP protocol. There are several parameters through which you can adjust the video performance:



■ **Frame size**

You can set up different video resolutions for different viewing devices. For example, you can configure a smaller frame size and lower bit rate for remote viewing on mobile phones and a larger video size and a higher bit rate for live viewing on web browsers, or recording the stream to an NVR. Note that a larger frame size takes up more bandwidth.

■ **Maximum frame rate**

This limits the maximum refresh frame rate per second. Set the frame rate higher for smoother video quality and for recognizing moving objects in the field of view.

If the power line frequency is set to 50Hz , the frame rates are selectable at 1fps, 2fps, 3fps, 5fps, 8fps, 10fps, 12fps, 15fps, and up to 25fps. If the power line frequency is set to 60Hz, the frame rates are selectable at 1fps, 2fps, 3fps, 5fps, 8fps, 10fps, 12fps, 15fps, and up to 30fps. You can also select **Customize** and manually enter a value.

The frame rate will decrease if you select a higher resolution.

■ Intra frame period

Determine how often for firmware to plant an I frame. The shorter the duration, the more likely you will get better video quality, but at the cost of higher network bandwidth consumption. Select the intra frame period from the following durations: 1/4 second, 1/2 second, 1 second, 2 seconds, 3 seconds, and 4 seconds.

■ Smart stream III

■ Dynamic Intra frame period

High quality motion codecs, such as H.265, utilize the redundancies between video frames to deliver video streams at a balance of quality and bit rate.

The encoding parameters are summarized and illustrated below. The **I-frames** are completely self-referential and they are largest in size. The **P-frames** are predicted frames. The encoder refers to the previous I- or P-frames for redundant image information.

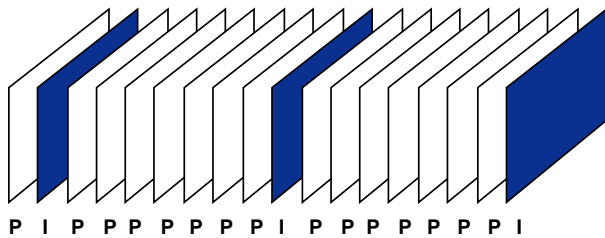

H.264/265 Frame Types

By dynamically prolonging the intervals for I-frames insertion to up to 10 seconds, the bit rates required for streaming a video can be tremendously reduced. When streaming a video of a static scene, the Dynamic Intra frame feature can save up to 53% of bandwidth. The amount of bandwidth thus saved is also determined by the activities in the field of view. If activities occur in the scene, firmware automatically shortens the I-frame insertion intervals in order to maintain image quality. In the low light or night conditions, the sizes of P-frames tend to be enlarged due to the noises, and hence the bandwidth saving effect is also reduced.

Streaming a typical 2MP scene normally requires 3~4Mb/s of bandwidth. With the Dynamic Intra frame function, the bandwidth for streaming a medium-traffic scene can be reduced to 2~3Mb/s, and during the no-traffic period of time, down to 500kb/s.

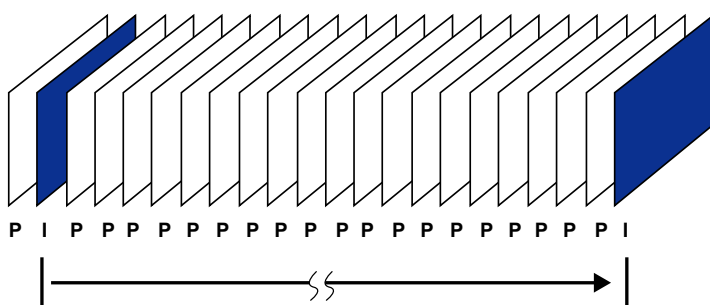

Static scene

Dynamic Intra Frame w/ static scenes

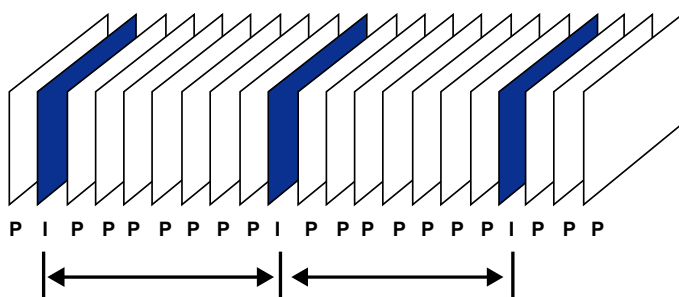

Activities

Dynamic Intra Frame w/ activities in scenes

With the H.265 codec in an optimal scenario and when Dynamic Intra frame is combined with the Smart Stream function, an 80% of bandwidth saving can be achieved compared with using H.264 without enabling these bandwidth-saving features.

■ Smart FPS

In a static scene, the algorithm puts old frames in queue when no motions occur in scene. When motions occur, the encoding returns to normal to deliver real-time streaming.

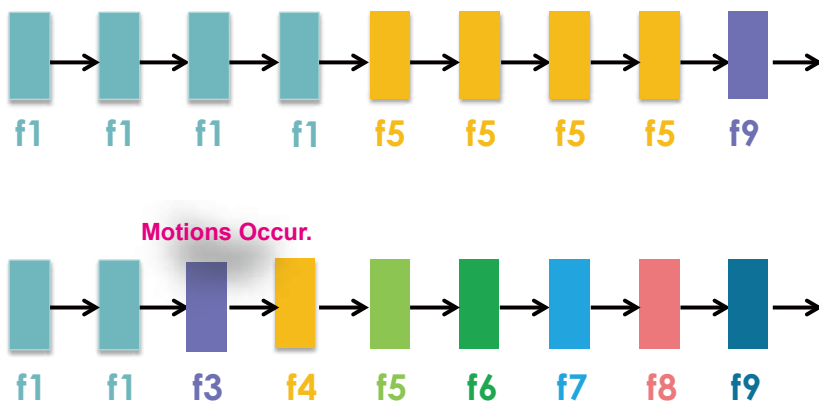

By queuing the old frames from a static scene, both the computing efforts and the size of P frames are reduced. It is beneficial for keeping up with the frame rate requirements.

A default frame difference threshold, 1%, is embedded in firmware for returning from Smart FPS to normal encoding when motions occur.



NOTE:

Comparing with Smart Stream II, Smart Stream III has two more configurable options: [Smart Q](#), and [Smart FPS](#).

- **Smart codec:** Smart codec effectively reduces the quality of the whole or the non-interested areas on a screen and therefore reduces the bandwidth consumed.

You can manually specify the video quality for the foreground and the background areas.



Select an operation mode if Smart codec is preferred.

- **Auto tracking:** The Auto mode configures the whole screen into the non-interested area. The video quality of part of the screen returns to normal when one or more objects move in that area. The remainder of the screen where there are no moving objects (no pixel changes) will still be transmitted in low-quality format.
- **Manual:** The Manual mode allows you to configure 3 ROI windows (Region of Interest, with Foreground quality) on the screen. Areas not included in any ROI windows will be considered as the non-interested areas. The details in the ROI areas will be transmitted in a higher-quality video format.

As illustrated below, the upper screen may contain little details of your interest, while the sidewalk on the lower screen is included in an ROI window.



As the result, the lower screen is constantly displayed in high details, while the upper half is transmitted using a lower-quality format. Although the upper half is transmitted using a lower quality format, you still have an awareness of what is happening on the whole screen.

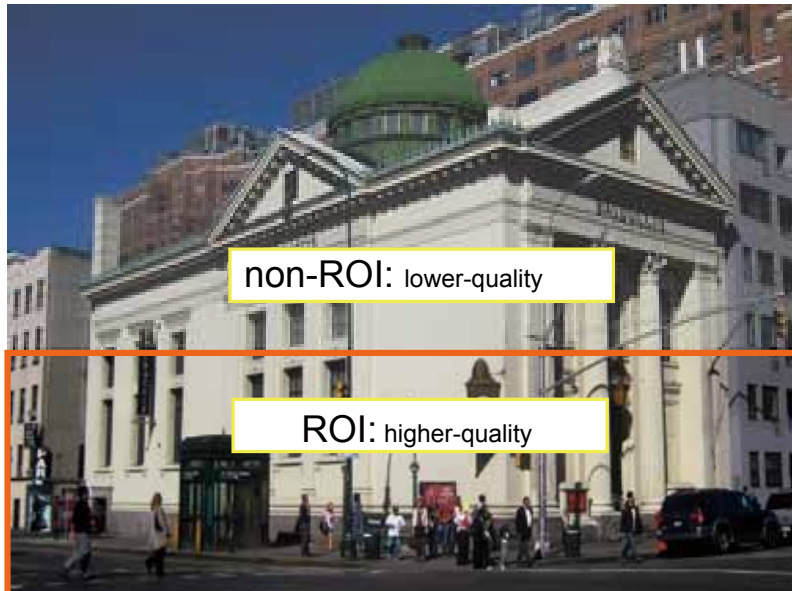

- **Hybrid:** The major difference between the “Manual” mode and the “Hybrid” mode is that:

In the “**Hybrid**” mode, any objects entering the non-interested area will restore the video quality of the moving objects and the area around them. The video quality of the associated non-interested area is immediately restored to normal to cover the moving objects.

In the “**Manual**” mode, the non-interested area is always transmitted using a low-quality format regardless of the activities occurring inside.

Quality priority: ([Help](#))



- **Quality priority:** Use the slide bar to tune the quality contrast between the ROI and non-interested areas.

The farther the slide bar button is to the right, the higher the image quality of the ROI areas. On the contrary, the farther the slide bar button to the left, the higher the image quality of the non-interested area.

In this way, you may set up an ROI window as a privacy mask by covering a protected area using an ROI window, while the rest of the screen becomes the non-interested area. You may then configure the non-interested area to have a high image quality, or vice versa.

You should also select the Maximum bit rate from the pull-down menu as the threshold to contain the bandwidth consumption for both the high- and low-quality video sections in a smart stream.

■ Bit rate control

Constrained bit rate:

A complex scene generally produces a larger file size, meaning that higher bandwidth will be needed for data transmission. The bandwidth utilization is configurable to match a selected level, resulting in mutable video quality performance. The bit rates are selectable at the following rates: 20Kbps, 30Kbps, 40Kbps, 50Kbps, 64Kbps, 128Kbps, 256Kbps, 512Kbps, 768Kbps, 1Mbps, 2Mbps, 3Mbps, 4Mbps, 6Mbps, 8Mbps, 10Mbps, 12Mbps, 14Mbps, ~ to 40Mbps. You can also select **Customize** and manually enter a value up to 40Mbps.

- - **Target quality**: Select a desired quality ranging from Medium to Excellent.
- **Maximum bit rate**: select a bit rate from the pull-down menu. The bit rate ranges from 20kbps to a maximum of 40Mbps. The bit rate then becomes the Average or Upper bound bit rate number. The Network Camera will strive to deliver video streams around or within the bit rate limitation you impose.
- **Policy**: If Frame Rate Priority is selected, the Network Camera will try to maintain the frame rate per second performance, while the image quality will be compromised. If Image quality priority is selected, the Network Camera may drop some video frames in order to maintain image quality.

Smart Q: Select ON or OFF to enable or disable the feature. Smart Q is scene-aware. The Smart Q reduces frame size and bit rate consumption through the following:

- Dynamically adjusting the image quality for scenes in different luminosities in low light frames. Less noises means less of the bandwidth consumed.
- Endorsing different qualities for the I frames and P frames, and hence reduces the frame size.
- Dividing a single frame into different sections, and giving these sections different qualities. For a highly complex area, such as an area with dense vegetation, screen windows, or repeated patterns (complex textiles patterns like wall paper), having a lower quality value actually poses little effects on human eyes.

Unnecessary quality is unrecognized by human eyes and wastes the bit rate.

The Smart Q streaming can save up to 50% to 80% of bandwidth in different illumination conditions while keeping the same imaging quality. These numbers come from the comparison between Smart Stream II and Smart Stream III streamings.

Fixed quality:

On the other hand, if **Fixed quality** is selected, all frames are transmitted with the same quality; bandwidth utilization is therefore unpredictable. The video quality can be adjusted to the following settings: Medium, Standard, Good, Detailed, and Excellent. You can also select **Customize** and manually enter a value.

Maximum bit rate: With the guaranteed image quality, you might still want to place a bit rate limitation to control the size of video streams for bandwidth and storage concerns. The configurable bit rate starts from 1Mbps to 40Mbps.

The Maximum bit rate setting in the Fixed quality configuration can ensure a reasonable and limited use of network bandwidth. For example, in low light conditions where a Fixed quality setting is applied, video packet sizes can tremendously increase when noises are produced with electrical gains.

You may also manually enter a bit rate number by selecting the **Customized** option.

If the **JPEG** mode is selected, the Network Camera sends consecutive JPEG images to the client, producing a moving effect similar to a filmstrip. Every single JPEG image transmitted guarantees the same image quality, which in turn comes at the expense of variable bandwidth usage. Because the media contents are a combination of JPEG images, no audio data is transmitted to the client. There are three parameters provided in MJPEG mode to control the video performance:

JPEG

Frame size:

Maximum frame rate:

Bit rate control

Constrained bit rate:

Fixed quality:

Quality:

Maximum bit rate:

■ Frame size

You can set up different video resolution for different viewing devices. For example, set a smaller frame size and lower bit rate for remote viewing on mobile phones and a larger video size and a higher bit rate for live viewing on web browsers. Note that a larger frame size takes up more bandwidth.

■ Maximum frame rate

This limits the maximum refresh frame rate per second. Set the frame rate higher for smoother video quality.

If the power line frequency is set to 50Hz (at the 5MP resolution), the frame rates are selectable at 1fps, 2fps, 3fps, 5fps, 8fps, 10fps, and 15fps. If the power line frequency is set to 60Hz, the frame rates are selectable at 1fps, 2fps, 3fps, 5fps, 8fps, 10fps, and 15fps. You can also select **Customize** and manually enter a value. The frame rate will decrease if you select a higher resolution.

■ Video quality

Refer to the previous page setting an average or upper bound threshold for controlling the bandwidth consumed for transmitting motion jpegs. The configuration method is identical to that for H.264.

For Constant Bit Rate and other settings, refer to the previous page for details.



NOTE:

- ▶ *Video quality and fixed quality refers to the **compression rate**, so a lower value will produce higher quality.*
- ▶ *Converting high-quality video may significantly increase the CPU loading, and you may encounter streaming disconnection or video loss while capturing a complicated scene. In the event of occurrence, we suggest you customize a lower video resolution or reduce the frame rate to obtain smooth video.*

Media > Audio

Audio Settings

Audio settings

Mute AEC

Internal microphone input gain:
0
100%

 70%

Audio type

G.711: pcmu ▾

G.726 bit rate: 32 Kbps ▾

Mute: Select this option to disable audio transmission from the Network Camera to all clients. Note that if muted, no audio data will be transmitted even if audio transmission is enabled on the Client Settings page. In that case, the following message is displayed:

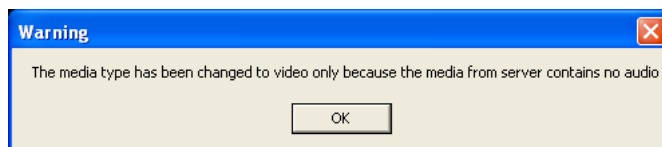

Internal microphone input: Select the gain of the external audio input according to ambient conditions. Adjust the gain from 0% to 100%.

Audio type: Select audio codec and the sampling bit rate .

- G.711 also provides good sound quality and requires about 64Kbps. Select pcmu (μ -Law) or pcma (A-Law) mode.
- G.726 is a speech codec standard covering voice transmission at rates of 16, 24, 32, and 40kbit/s.

When completed with the settings on this page, click **Save** to enable the settings.__

Network > General settings

This section explains how to configure a wired network connection for the Network Camera.

Network Type

Network type

LAN

Get IP address automatically

Use fixed IP address

Enable UPnP presentation

Enable UPnP port forwarding

PPPoE

Enable IPv6

Save

LAN

Select this option when the Network Camera is deployed on a local area network (LAN) and is intended to be accessed by local computers. The default setting for the Network Type is LAN. Please remember to click on the **Save** button when you complete the Network setting.

Get IP address automatically: Select this option to obtain an available dynamic IP address assigned by the DHCP server each time the camera is connected to the LAN.

Use fixed IP address: Select this option to manually assign a static IP address to the Network Camera.

Network type

LAN

Get IP address automatically

Use fixed IP address

IP address: 172.16.168.10

Subnet mask: 255.255.0.0

Default router: 172.16.0.1

Primary DNS: 192.168.0.21

Secondary DNS: 192.168.0.22

Primary WINS server: 192.168.0.21

Secondary WINS server: 192.168.0.22

Enable UPnP presentation

Enable UPnP port forwarding

PPPoE

Enable IPv6

Save

1. You can make use of VIVOTEK Installation Wizard 2 on the software CD to easily set up the Network Camera on LAN. Please refer to Software Installation on page 22 for details.
2. Enter the Static IP, Subnet mask, Default router, and Primary DNS provided by your ISP or network administrator.

Subnet mask: This is used to determine if the destination is in the same subnet. The default value is "255.255.255.0".

Default router: This is the gateway used to forward frames to destinations in a different subnet. Invalid router setting will disable the transmission to destinations across different subnets.

Primary DNS: The primary domain name server that translates hostnames into IP addresses.

Secondary DNS: Secondary domain name server that backups the Primary DNS.

Primary WINS server: The primary WINS server that maintains the database of computer names and IP addresses.

Secondary WINS server: The secondary WINS server that maintains the database of computer names and IP addresses.

Enable UPnP presentation: Select this option to enable UPnP™ presentation for your Network Camera so that whenever a Network Camera is presented to the LAN, the shortcuts to connected Network Cameras will be listed in My Network Places. You can click the shortcut to link to the web browser. Currently, UPnP™ is supported by Windows XP or later. Note that to utilize this feature, please make sure the UPnP™ component is installed on your computer.

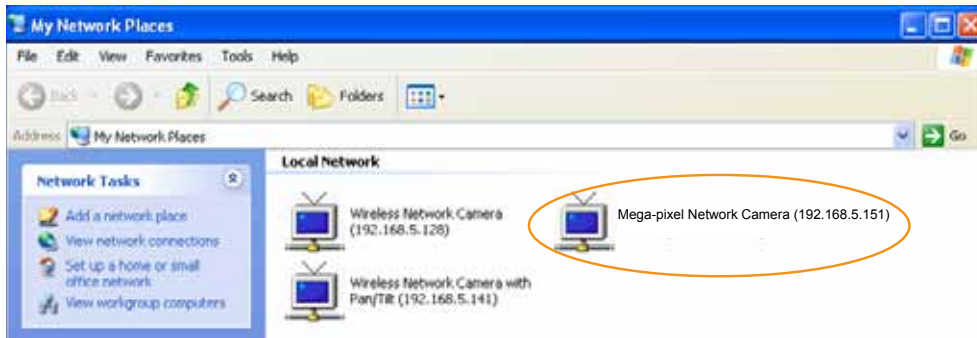

Enable UPnP port forwarding: To access the Network Camera from the Internet, select this option to allow the Network Camera to open ports automatically on the router so that video streams can be sent out from a LAN. To utilize of this feature, make sure that your router supports UPnP™ and it is activated.

PPPoE (Point-to-point over Ethernet)

Select this option to configure your Network Camera to make it accessible from anywhere as long as there is an Internet connection. Note that to utilize this feature, it requires an account provided by your ISP.

Follow the steps below to acquire your Network Camera’s public IP address.

1. Set up the Network Camera on the LAN.
2. Go to Configuration > Event > Event settings > Add server (please refer to Add server on page 136) to add a new email or FTP server.
3. Go to Configuration > Event > Event settings > Add media (please refer to Add media on page 141).
Select System log so that you will receive the system log in TXT file format which contains the Network Camera’s public IP address in your email or on the FTP server.
4. Go to Configuration > Network > General settings > Network type. Select PPPoE and enter the user name and password provided by your ISP. Click **Save** to enable the setting.

Network type

LAN

PPPoE

User name:

Password:

Confirm password:

Enable IPv6

5. The Network Camera will reboot.
6. Disconnect the power to the Network Camera; remove it from the LAN environment.

 **NOTE:**

- ▶ If the default ports are already used by other devices connected to the same router, the Network Camera will select other ports for the Network Camera.
- ▶ If UPnP™ is not supported by your router, you will see the following message:
Error: Router does not support UPnP port forwarding.
- ▶ Steps to enable the UPnP™ user interface on your computer:
Note that you must log on to the computer as a system administrator to install the UPnP™ components.

1. Go to Start, click **Control Panel**, then click **Add or Remove Programs**.

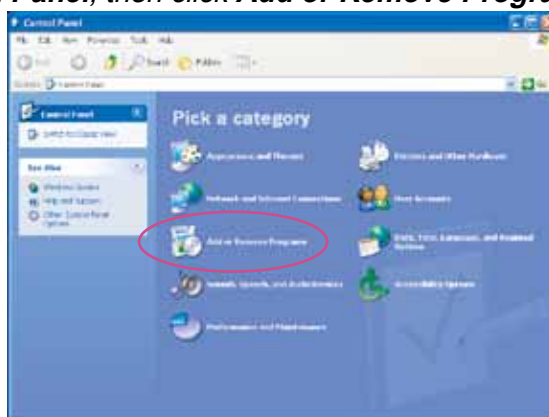

2. In the Add or Remove Programs dialog box, click **Add/Remove Windows Components**.

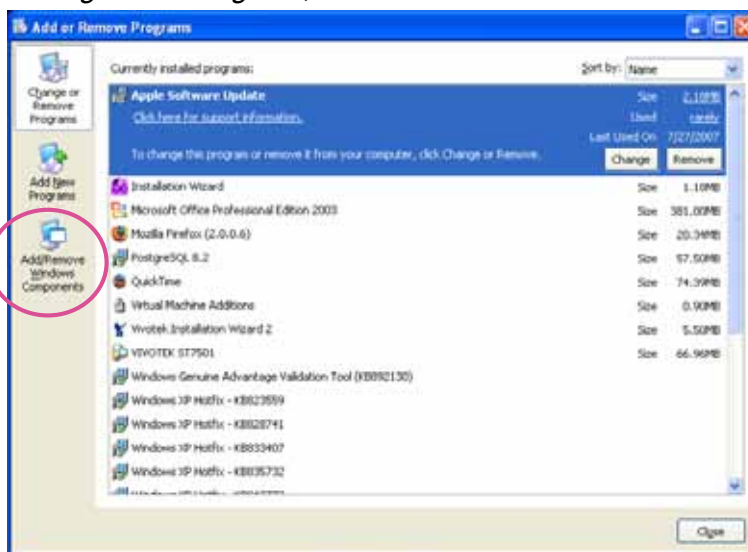

3. In the Windows Components Wizard dialog box, select **Networking Services** and click **Details**.

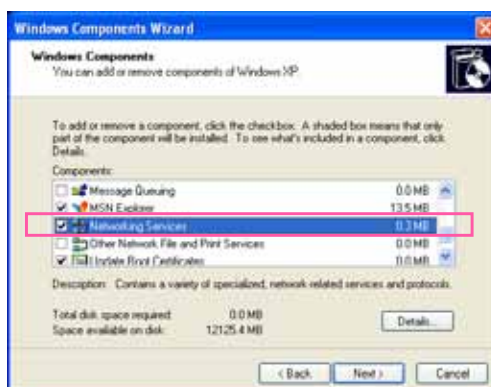

4. In the Networking Services dialog box, select **Universal Plug and Play** and click **OK**.

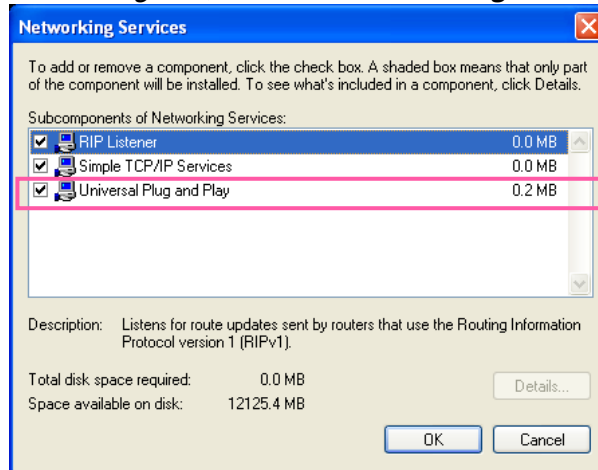

5. Click **Next** in the following window.

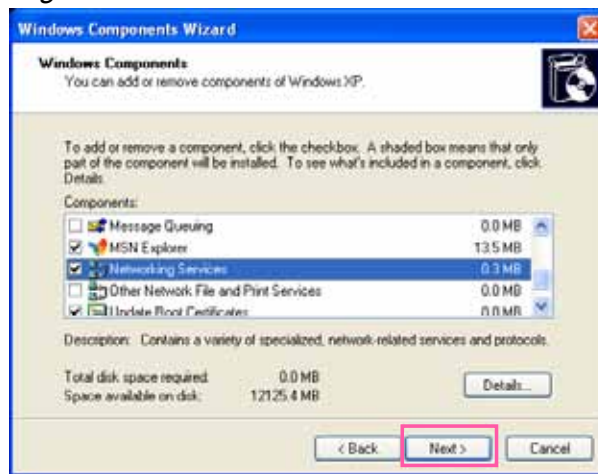

6. Click **Finish**. UPnP™ is enabled.

► **How does UPnP™ work?**

UPnP™ networking technology provides automatic IP configuration and dynamic discovery of devices added to a network. Services and capabilities offered by networked devices, such as printing and file sharing, are available among each other without the need for cumbersome network configuration. In the case of Network Cameras, you will see Network Camera shortcuts under My Network Places.

► **Enabling UPnP port forwarding allows the Network Camera to open a secondary HTTP port on the router-not HTTP port-meaning that you have to add the secondary HTTP port number to the Network Camera's public address in order to access the Network Camera from the Internet. For example, when the HTTP port is set to 80 and the secondary HTTP port is set to 8080, refer to the list below for the Network Camera's IP address.**

From the Internet	In LAN
http://203.67.124.123:8080	http://192.168.4.160 or http://192.168.4.160:8080

► **If the PPPoE settings are incorrectly configured or the Internet access is not working, restore the Network Camera to factory default; please refer to Restore on page 67 for details. After the Network Camera is reset to factory default, it will be accessible on the LAN.**

Enable IPv6

Select this option and click **Save** to enable IPv6 settings.

Please note that this only works if your network environment and hardware equipment support IPv6. The browser should be Microsoft® Internet Explorer 6.5, Mozilla Firefox 3.0 or above.

Network type

LAN

PPPoE

User name:

Password:

Confirm password:

Enable IPv6

[IPv6 information](#)

Manually setup the IP address

When IPv6 is enabled, by default, the network camera will listen to router advertisements and be assigned with a link-local IPv6 address accordingly.

IPv6 Information: Click this button to obtain the IPv6 information as shown below.



If your IPv6 settings are successful, the IPv6 address list will be listed in the pop-up window. The IPv6 address will be displayed as follows:

Refers to Ethernet

[eth0 address]	
2001:0c08:2500:0002:0202:d1ff:fe04:65f4/64@Global	— Link-global IPv6 address/network mask
fe80:0000:0000:0000:0202:d1ff:fe04:65f4/64@Link	— Link-local IPv6 address/network mask
[Gateway]	
fe80::211:d8ff:fea2:1a2b	
[DNS]	
2010:05c0:978d::	

Please follow the steps below to link to an IPv6 address:

1. Open your web browser.
2. Enter the link-global or link-local IPv6 address in the address bar of your web browser.
3. The format should be:



4. Press **Enter** on the keyboard or click **Refresh** button to refresh the webpage.
For example:

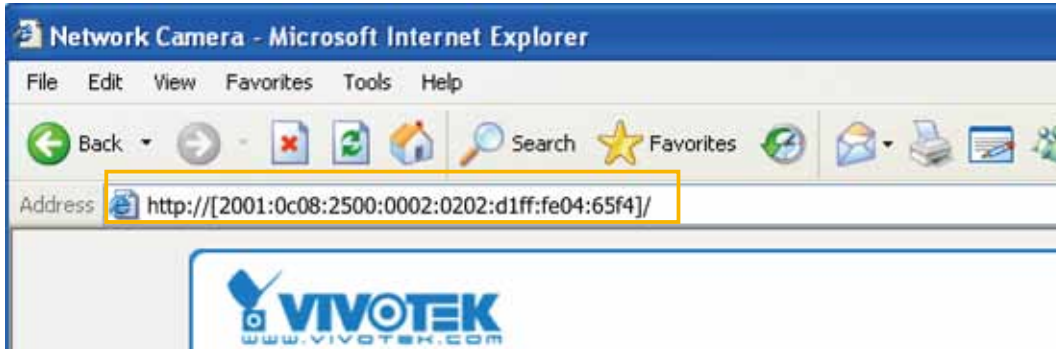

NOTE:

- ▶ If you have a Secondary HTTP port (the default value is 8080), you can also link to the webpage using the following address format: (Please refer to **HTTP** streaming on page 102 for detailed information.)



- ▶ If you choose PPPoE as the Network Type, the [PPP0 address] will be displayed in the IPv6 information column as shown below.

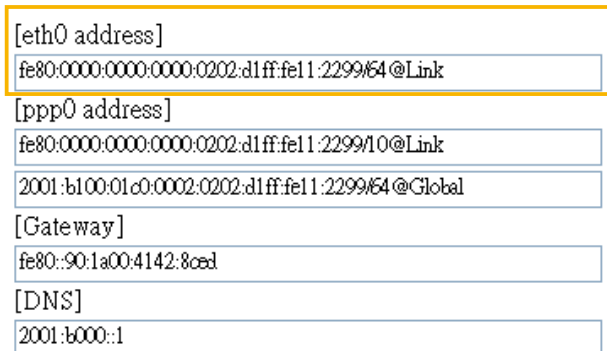

Manually setup the IP address: Select this option to manually set up IPv6 settings if your network environment does not have DHCPv6 server and router advertisements-enabled routers. If you check this item, the following blanks will be displayed for you to enter the corresponding information:

Enable IPv6

IPv6 information

Manually setup the IP address

Optional IP address / Prefix length /

Optional default router

Optional primary DNS

Network > Streaming protocols

HTTP streaming

To utilize HTTP authentication, make sure that you have set a password for the Network Camera first; please refer to Security > User account on page 113 for details.

Authentication: Depending on your network security requirements, the Network Camera provides two types of security settings for an HTTP transaction: basic and digest.

If **basic** authentication is selected, the password is sent in plain text format and there can be potential risks of being intercepted. If **digest** authentication is selected, user credentials are encrypted using MD5 algorithm and thus provide better protection against unauthorized accesses.

HTTP port / Secondary HTTP port: By default, the HTTP port is set to 80 and the secondary HTTP port is set to 8080. They can also be assigned to another port number between 1025 and 65535. If the ports are incorrectly assigned, the following warning messages will be displayed:

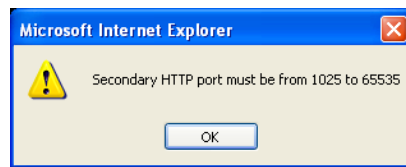

To access the Network Camera on the LAN, both the HTTP port and secondary HTTP port can be used to access the Network Camera. For example, when the HTTP port is set to 80 and the secondary HTTP port is set to 8080, refer to the list below for the Network Camera's IP address.

On the LAN

http://192.168.4.160 or
http://192.168.4.160:8080

Access name for stream 1 ~ 3: This Network camera supports multiple streams simultaneously. The access name is used to identify different video streams. Users can click **Media > Video > Stream settings** to set up the video quality of linked streams. For more information about how to set up the video quality, please refer to Stream settings on page 84.

When using **Mozilla Firefox** to access the Network Camera and the video mode is set to JPEG, users will receive video comprised of continuous JPEG images. This technology, known as "server push", allows the Network Camera to feed live pictures to Mozilla Firefox.

URL command -- <http://<ip address>:<http port>/<access name for stream 1, 2, 3>>

For example, when the Access name for [stream 2](#) is set to [video2.mjpg](#):

1. Launch Mozilla Firefox or Netscape.
2. Type the above URL command in the address bar. Press **Enter**.
3. The JPEG images will be displayed in your web browser.



NOTE:

- ▶ *Microsoft® Internet Explorer does not support server push technology; therefore, you will not be able to access a video stream using <http://<ip address>:<http port>/<access name for stream 1, 2, 3>>.*

RTSP Streaming

To utilize RTSP streaming authentication, make sure that you have set a password for controlling the access to video stream first. Please refer to Security > User account on page 113 for details.

HTTP streaming
RTSP

Authentication:	<input type="text" value="basic"/>
Access name for stream 1:	<input type="text" value="live.sdp"/>
Access name for stream 2:	<input type="text" value="live2.sdp"/>
Access name for stream 3:	<input type="text" value="live3.sdp"/>
RTSP port:	<input type="text" value="554"/>
RTP port for video:	<input type="text" value="5556"/>
RTCP port for video:	<input type="text" value="5557"/>
RTP port for metadata:	<input type="text" value="5556"/>
RTCP port for metadata:	<input type="text" value="5557"/>
▶ Multicast settings for stream 1	
▶ Multicast settings for stream 2	
▶ Multicast settings for stream 3	

Authentication: Depending on your network security requirements, the Network Camera provides three types of security settings for streaming via RTSP protocol: disable, basic, and digest. If **basic** authentication is selected, the password is sent in plain text format, but there can be potential risks of it being intercepted. If **digest** authentication is selected, user credentials are encrypted using MD5 algorithm, thus providing better protection against unauthorized access. The availability of the RTSP streaming for the three authentication modes is listed below:

	Quick Time player	VLC
Disable	O	O
Basic	O	O
Digest	O	X

Access name for stream 1 ~ 3: This Network camera supports multiple streams simultaneously. The access name is used to differentiate the streaming source. If you want to use an **RTSP player** to access the Network Camera, you have to set the video mode to **H.264 or H.265** and use the following RTSP URL command to request transmission of the streaming data.

rtsp://<ip address>:<rtsp port>/<access name for stream 1 to 3>
 For example, when the access name for **stream 1** is set to **live.sdp**:

1. Launch an RTSP player.
2. Choose File > Open URL. A URL dialog box will pop up.
3. Type the above URL command in the text box.
4. The live video will be displayed in your player as shown below.

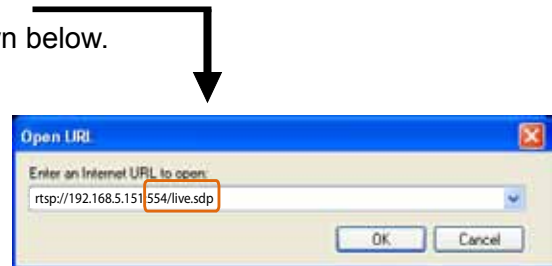

RTSP port /RTP port for video, audio/ RTCP port for video, audio

- RTSP (Real-Time Streaming Protocol) controls the delivery of streaming media. By default, the port number is set to 554.
- The RTP (Real-time Transport Protocol) is used to deliver video and audio data to the clients. By default, the RTP port for video is set to 5556.
- The RTCP (Real-time Transport Control Protocol) allows the Network Camera to transmit the data by monitoring the Internet traffic volume. By default, the RTCP port for video is set to 5557.

The ports can be changed to values between 1025 and 65535. The RTP port must be an even number and the RTCP port is the RTP port number plus one, and thus is always an odd number. When the RTP port changes, the RTCP port will change accordingly.

If the RTP ports are incorrectly assigned, the following warning message will be displayed:

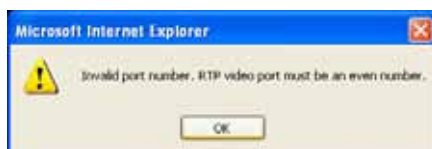

Multicast settings for streams: Click the items to display the detailed configuration information. Select the Always multicast option to enable multicast for video streams.

▼ Multicast settings for stream 1

Always multicast

Multicast group address:

Multicast video port:

Multicast RTCP video port:

Multicast metadata port:

Multicast RTCP metadata port:

Multicast audio port:

Multicast RTCP audio port:

Multicast TTL [1~255]:

▼ Multicast settings for stream 2

Always multicast

Multicast group address:

Multicast video port:

Multicast RTCP video port:

Multicast metadata port:

Multicast RTCP metadata port:

Multicast audio port:

Multicast RTCP audio port:

Multicast TTL [1~255]:

▶ Multicast settings for stream 3

Unicast video transmission delivers a stream through point-to-point transmission; multicast, on the other hand, sends a stream to the multicast group address and allows multiple clients to acquire the stream at the same time by requesting a copy from the multicast group address. Therefore, enabling multicast can effectively save Internet bandwidth.

The ports can be changed to values between 1025 and 65535. The multicast RTP port must be an even number and the multicast RTCP port number is the multicast RTP port number plus one, and thus is always odd. When the multicast RTP port changes, the multicast RTCP port will change accordingly.

If the multicast RTP video ports are incorrectly assigned, the following warning message will be displayed:

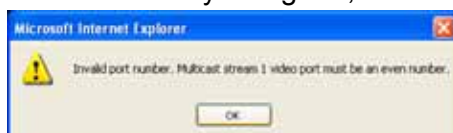

Multicast TTL [1~255]: The multicast TTL (Time To Live) is the value that tells the router the range a packet can be forwarded.

Initial TTL	Scope
0	Restricted to the same host
1	Restricted to the same subnetwork
32	Restricted to the same site
64	Restricted to the same region
128	Restricted to the same continent
255	Unrestricted in scope

IMPORTANT:

The Multicast metadata port is utilized by VIVOTEK VADP modules to transfer video analytics results, PTZ stream, textual data, and event messages between the camera and the client side running and observing the video analysis. If your client side computer is located outside the local network, you may need to open the associated TCP port on routers and firewall.

Network > DDNS

This section explains how to configure the dynamic domain name service for the Network Camera. DDNS is a service that allows your Network Camera, especially when assigned with a dynamic IP address, to have a fixed host and domain name.

Express link

Express Link is a free service provided by VIVOTEK server, which allows users to register a domain name for a network device. One URL can only be mapped to one MAC address. This service will examine if the host name is valid and automatically open a port on your router. If using DDNS, the user has to manually configure UPnP port forwarding. Express Link is more convenient and easier to set up.

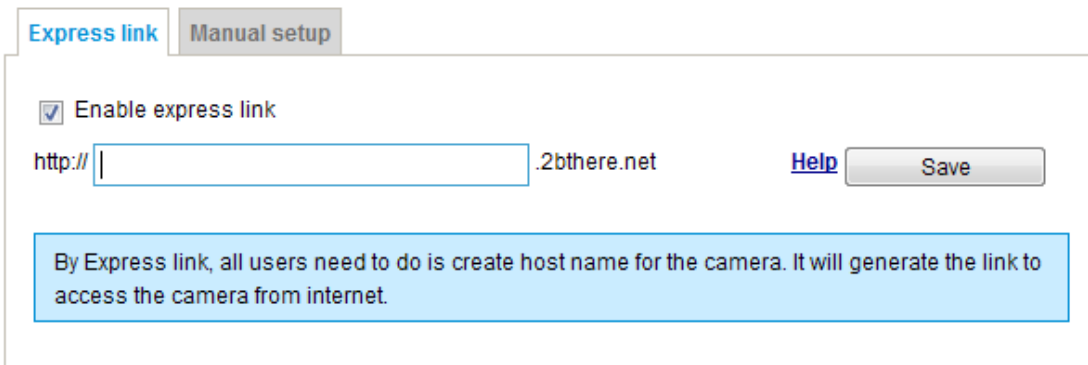

Please follow the steps below to enable Express Link:

1. Make sure that your router supports UPnP port forwarding and it is activated.
2. Check **Enable express link**.
3. Enter a host name for the network device and click **Save**. If the host name has been used by another device, a warning message will show up. If the host name is valid, it will display a message as shown below.

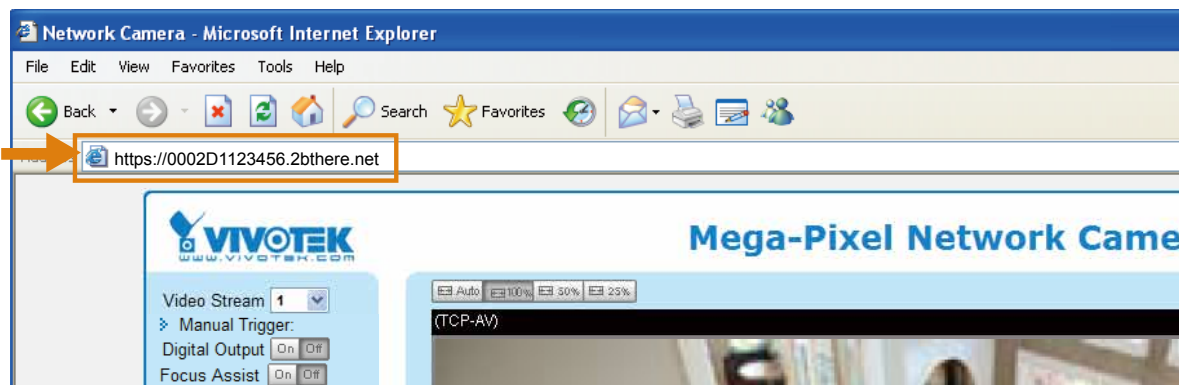

Manual setup

DDNS: Dynamic domain name service

DDNS: Dynamic domain name service

Enable DDNS:

Provider:

Host name:

User name:

Password:

Enable DDNS: Select this option to enable the DDNS setting.

Provider: Select a DDNS provider from the provider drop-down list.

VIVOTEK offers **Safe100.net**, a free dynamic domain name service, to VIVOTEK customers. It is recommended that you register **Safe100.net** to access VIVOTEK's Network Cameras from the Internet. Additionally, we offer other DDNS providers, such as Dyn dns.org(Dynamic), Dyn dns.org(Custom), TZO.com, DHS.org, CustomSafe100, dyn-interfree.it.

Note that before utilizing this function, please apply for a dynamic domain account first.

■ Safe100.net

1. In the DDNS column, select **Safe100.net** from the drop-down list. Click **I accept** after reviewing the terms of the Service Agreement.
2. In the Register column, fill in the Host name (xxxx.safe100.net), Email, Key, and Confirm Key, and click **Register**. After a host name has been successfully created, a success message will be displayed in the DDNS Registration Result column.

Register

Host name:

Email:

Key:

Confirm key:

To apply for a domain name for the camera, or to modify the previously registered information, fill in the following fields and then click "Register".

DDNS Registration Result

Upon successful registration, you can click to automatically upload relevant information to the DDNS form or you can manually fill it in. Then, click "Save" to save new settings.

3. Click **Copy** and all the registered information will automatically be uploaded to the corresponding fields in the DDNS column at the top of the page as seen in the picture.

DDNS: Dynamic domain name service

Enable DDNS:

Provider: Safe100.net

Host name: WTK.safe100.net [*safe100.net]

Email: wtk@vivotek.com

Key: ●●●●

Save

Register

Host name: WTK.safe100.net

Email: wtk@vivotek.com

Key: ●●●● **Forget key**

Confirm key: ●●●●

To apply for a domain name for the camera, or to modify the previously registered information, fill in the following fields and then click "Register".

Register

DDNS Registration Result:

[Register] Successfully Your account information has been mailed to registered e-mail address

Upon successful registration, you can click [copy](#) to automatically upload relevant information to the DDNS form or you can manually fill it in. Then, click "Save" to save new settings.

4. Select Enable DDNS and click **Save** to enable the setting.

■ CustomSafe100

VIVOTEK offers documents to establish a CustomSafe100 DDNS server for distributors and system integrators. You can use CustomSafe100 to register a dynamic domain name if your distributor or system integrators offer such services.

1. In the DDNS column, select CustomSafe100 from the drop-down list.
2. In the Register column, fill in the Host name, Email, Key, and Confirm Key; then click **Register**. After a host name has been successfully created, you will see a success message in the DDNS Registration Result column.
3. Click **Copy** and all for the registered information will be uploaded to the corresponding fields in the DDNS column.
4. Select Enable DDNS and click **Save** to enable the setting.

Forget key: Click this button if you have forgotten the key to Safe100.net or CustomSafe100. Your account information will be sent to your email address.

Refer to the following links to apply for a dynamic domain account when selecting other DDNS providers:

- [Dyndns.org\(Dynamic\) / Dyndns.org\(Custom\)](http://www.dyndns.com/): visit <http://www.dyndns.com/>

Network > QoS (Quality of Service)

Quality of Service refers to a resource reservation control mechanism, which guarantees a certain quality to different services on the network. Quality of service guarantees are important if the network capacity is insufficient, especially for real-time streaming multimedia applications. Quality can be defined as, for instance, a maintained level of bit rate, low latency, no packet dropping, etc.

The following are the main benefits of a QoS-aware network:

- The ability to prioritize traffic and guarantee a certain level of performance to the data flow.
- The ability to control the amount of bandwidth each application may use, and thus provide higher reliability and stability on the network.

Requirements for QoS

To utilize QoS in a network environment, the following requirements must be met:

- All network switches and routers in the network must include support for QoS.
- The network video devices used in the network must be QoS-enabled.

QoS models

CoS (the VLAN 802.1p model)

IEEE802.1p defines a QoS model at OSI Layer 2 (Data Link Layer), which is called CoS, Class of Service. It adds a 3-bit value to the VLAN MAC header, which indicates the frame priority level from 0 (lowest) to 7 (highest). The priority is set up on the network switches, which then use different queuing disciplines to forward the packets.

Below is the setting column for CoS. Enter the **VLAN ID** of your switch (0~4095) and choose the priority for each application (0~7).

CoS

Enable CoS

VLAN ID:

Live video: ▼

Live audio: ▼

Event/Alarm: ▼

Management: ▼

If you assign Video the highest level, the switch will handle video packets first.



NOTE:

- ▶ A VLAN Switch (802.1p) is required. Web browsing may fail if the CoS setting is incorrect.
- ▶ The Class of Service technologies do not guarantee a level of service in terms of bandwidth and delivery time; they offer a "best-effort." Users can think of CoS as "coarsely-grained" traffic control and QoS as "finely-grained" traffic control.
- ▶ Although CoS is simple to manage, it lacks scalability and does not offer end-to-end guarantees since it is based on L2 protocol.

QoS/DSCP (the DiffServ model)

DSCP-ECN defines QoS at Layer 3 (Network Layer). The Differentiated Services (DiffServ) model is based on packet marking and router queuing disciplines. The marking is done by adding a field to the IP header, called the DSCP (Differentiated Services Codepoint). This is a 6-bit field that provides 64 different class IDs. It gives an indication of how a given packet is to be forwarded, known as the Per Hop Behavior (PHB). The PHB describes a particular service level in terms of bandwidth, queueing theory, and dropping (discarding the packet) decisions. Routers at each network node classify packets according to their DSCP value and give them a particular forwarding treatment; for example, how much bandwidth to reserve for it.

Below are the setting options of DSCP (DiffServ Codepoint). Specify the DSCP value for each application (0~63).

QoS/DSCP

Enable QoS/DSCP

Live video:

Live audio:

Event/Alarm:

Management:

Note that different vendors of network devices might have different methodologies and unique implementations. Shown below is a sample corresponding information from a Cisco switch. You should enter a DSCP tag value according to the information provided by the network devices.

Ingress DSCP	Output Queue	Ingress DSCP	Output Queue	Ingress DSCP	Output Queue	Ingress DSCP	Output Queue
0(BE)	1	16(CS2)	2	32(CS4)	3	48(CS6)	3
1	1	17	2	33	3	49	3
2	1	18(AF21)	2	34(AF41)	3	50	3
3	1	19	2	35	3	51	3
4	1	20(AF22)	2	36(AF42)	3	52	3
5	1	21	2	37	3	53	3
6	1	22(AF23)	2	38(AF43)	3	54	3
7	1	23	2	39	3	55	3
8(CS1)	1	24(CS3)	3	40(CS5)	4	56(CS7)	3
9	1	25	3	41	4	57	3
10(AF11)	1	26(AF31)	3	42	4	58	3
11	1	27	3	43	4	59	3
12(AF12)	1	28(AF32)	3	44	4	60	3
13	1	29	3	45	4	61	3
14(AF13)	1	30(AF33)	3	46(EF)	4	62	3
15	1	31	3	47	4	63	3

Queue 1 has the lowest priority, queue 4 has the highest priority.

QoS/DSCP

Enable QoS/DSCP

Live video:

Live audio:

Event/Alarm:

Management:

QoS Baseline/Technical Marketing Classification and Marking Recommendations

Application	Layer3 Classification			Layer 2 CoS/MPLS EXP	
	IPP	PHB	DSCP		
IP Routing	6	CS6	48	6	
Voice	5	EF	46	5	
Interactive Video	4	AF41	34	4	QoS B
Streaming-Video	4	CS4	32	4	
Locally-defined Mission-Critical Data	3	-	25	3	
Call-signaling	3	AF31/CS3	26/24	3	
Transactional Data	2	AF21	18	2	
Network Management	2	CS2	16	2	
Bulk Data	1	AF11	10	1	

Network > SNMP (Simple Network Management Protocol)

This section explains how to use the SNMP on the network camera. The Simple Network Management Protocol is an application layer protocol that facilitates the exchange of management information between network devices. It helps network administrators to remotely manage network devices and find, solve network problems with ease.

- The SNMP consists of the following three key components:
 1. Manager: Network-management station (NMS), a server which executes applications that monitor and control managed devices.
 2. Agent: A network-management software module on a managed device which transfers the status of managed devices to the NMS.
 3. Managed device: A network node on a managed network. For example: routers, switches, bridges, hubs, computer hosts, printers, IP telephones, network cameras, web server, and database.

Before configuring SNMP settings on the this page, please enable your NMS first.

SNMP Configuration

Enable SNMPv1, SNMPv2c

Select this option and enter the names of Read/Write community and Read Only community according to your NMS settings.

Enable SNMPv1, SNMPv2c

SNMPv1, SNMPv2c Settings

Read/Write community:

Read only community:

Enable SNMPv3

This option contains cryptographic security, a higher security level, which allows you to set the Authentication password and the Encryption password.

- Security name: According to your NMS settings, choose Read/Write or Read Only and enter the community name.
- Authentication type: Select MD5 or SHA as the authentication method.
- Authentication password: Enter the password for authentication (at least 8 characters).
- Encryption password: Enter a password for encryption (at least 8 characters).

Enable SNMPv3

SNMPv3 Settings

Read/Write Security name:

Authentication Type:

Authentication Password:

Encryption Password:

Read only Security name:

Authentication Type:

Authentication Password:

Encryption Password:

Network > FTP

The newer firmware disabled the FTP port for security concerns. You can manually enable the FTP server service to enable the FTP function. You can disable the FTP server function when it is not in use.

FTP port: The FTP server allows the user to save recorded video clips. You can utilize VIVOTEK's Shepherd utility to upgrade the firmware via FTP server. By default, the FTP port is set to 21. It can also be assigned to another port number between 1025 and 65535.



Tips:

You can FTP the camera's IP address to download videos recorded in the SD card, or use the "<http://ip/cgi-bin/admin/lscrtl.cgi?cmd=search>" command to examine the recorded files on your SD card.

Security > User accounts

This section explains how to enable password protection and create multiple accounts.

Account management

Security > User accounts

The administrator account name is “root”, which is permanent and can not be deleted. If you want to add more accounts in the Account management window, please apply the password for the “root” account first.

The administrator can create up to 20 user accounts.

To create a new user,

1. Click to unfold the pull-down menu. Select **New user**.
2. Enter the new user’s name and password. Type the password identically in both text boxes.
Some, but not all special ASCII characters are supported: !, \$, %, -, ., @, ^, _, and ~.
You can use them in the password combination.

The strength of your password combination is shown on the right, use the combination of alphabetic, numeric, upper case, and lower case characters until the password strength is good enough.

3. Select the privilege level for the new user account. Click **Add** to enable the setting.
The privilege levels are listed below:

Administrator	Full control
Operator	Control DO, white-light illuminator, snapshot, and PTZ; unable to enter the camera Configuration page.
Viewer	Control DO, white-light illuminator, view, listen, PTZ, and talk through the camera interface.

Access rights are sorted by user privilege (Administrator, Operator, and Viewer). Only administrators can access the Configuration page. Although operators cannot access the Configuration page, they can use the URL Commands to get and set the value of parameters. For more information, please refer to URL Commands of the Network Camera on page 164. Viewers can only access the main page for live viewing.

Here you also can change a user’s access rights or delete user accounts.

1. Select an existing account to modify.
2. Make necessary changes and click **Update** or **Delete** to enable the setting.

Privilege management

Account management	Privilege management
<input type="checkbox"/> Allow anonymous viewing	
Operator:	<input checked="" type="checkbox"/> PTZ control
Viewer:	<input checked="" type="checkbox"/> PTZ control
<input type="button" value="Save"/>	

Digital Output & PTZ control: You can modify the management privilege as operators or viewers. Select or de-select the checkboxes, and then click **Save** to enable the settings. If you give Viewers the privilege, Operators will also have the ability to control the Network Camera through the main page. (Please refer to Configuration on page 57).

Allow anonymous viewing: If you select this item, any client can access the live stream without entering a User ID and Password.

Security > HTTPS (Hypertext Transfer Protocol over SSL)

This section explains how to enable authentication and encrypted communication over SSL (Secure Socket Layer). It helps protect streaming data transmission over the Internet on higher security level.

Create and Install Certificate Method

Before using HTTPS for communication with the Network Camera, a **Certificate** must be created first. There are three ways to create and install a certificate:

Create self-signed certificate

1. Select this option from a pull-down menu.
2. In the first column, select **Enable HTTPS secure connection**, then select a connection option: "HTTP & HTTPS" or "HTTPS only".
3. Click **Create certificate** to generate a certificate.

The screenshot shows the 'HTTPS' configuration page. The 'Enable HTTPS secure connection' checkbox is checked. Under 'Mode', 'HTTP & HTTPS' is selected. Under 'Certificate', the 'Certificate information' section is expanded, showing fields for Country (TW), State or province (Asia), Locality (Asia), Organization (VIVOTEK.Inc), Organization unit (VIVOTEK.Inc), Common name (www.vivotek.com), and Validity (3650 days). A 'Create certificate' button is highlighted with a yellow box. A blue dialog box is overlaid on the form, displaying the message: 'Please wait while the certificate is being generated...' with a progress bar.

4. The Certificate Information will automatically be displayed as shown below. You can click **Certificate properties** to view detailed information about the certificate.

The screenshot shows the 'Certificate information' panel. The 'Status' is 'Active'. The 'method' is 'Create self-signed certificate'. The 'Country' is 'TW', 'State or province' is 'Asia', 'Locality' is 'Asia', 'Organization' is 'VIVOTEK.Inc', 'Organization unit' is 'VIVOTEK.Inc', and 'Common name' is 'www.vivotek.com'. At the bottom, there is a link for 'Certificate properties' and a 'Remove certificate' button.

5. Click **Save** to preserve your configuration, and your current session with the camera will change to the encrypted connection.
6. If your web session does not automatically change to an encrypted HTTPS session, click **Home** to return to the main page. Change the URL address from “<http://>” to “<https://>” in the address bar and press **Enter** on your keyboard. Some Security Alert dialogs will pop up. Click **OK** or **Yes** to enable HTTPS.

https://

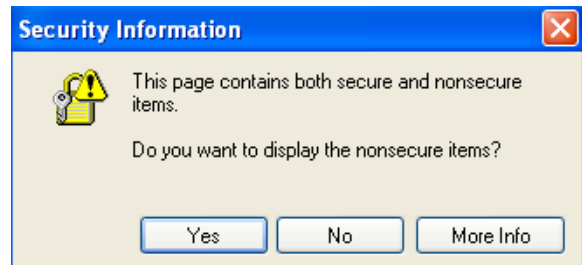
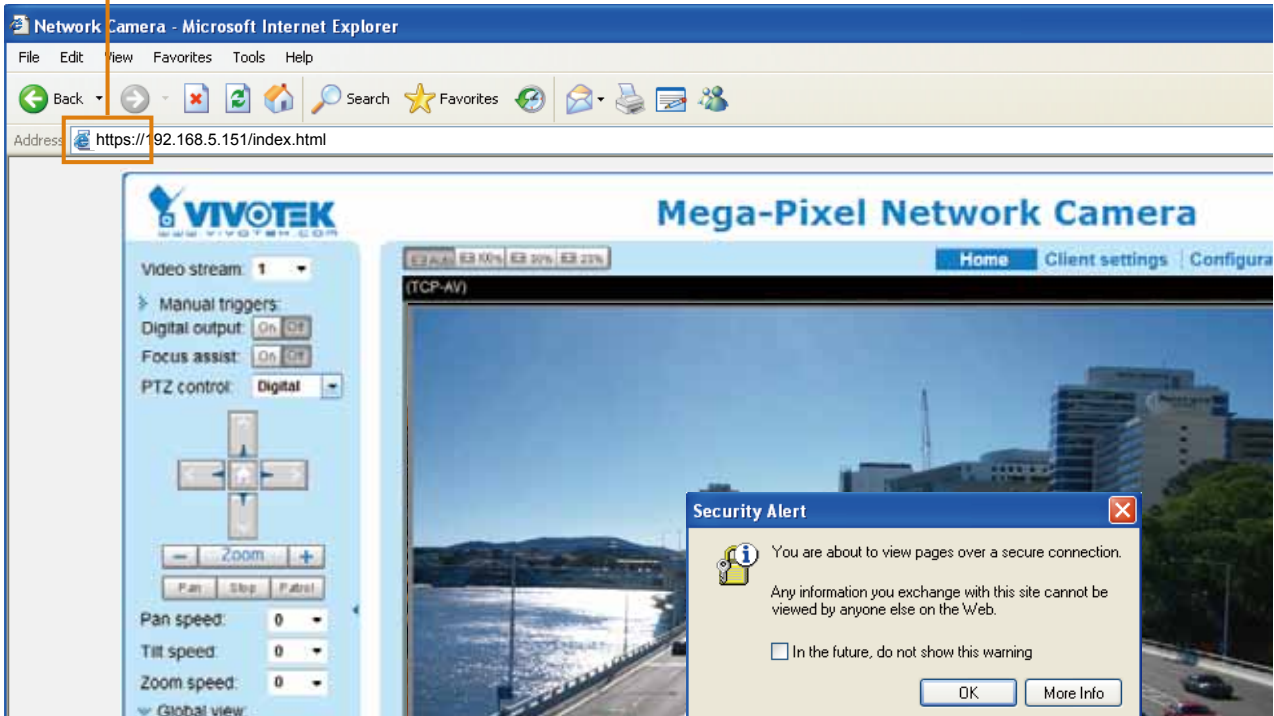

Create certificate request and install

1. Select the option from the **Method** pull-down menu.
2. Click **Create certificate** to proceed.
3. The following information will show up in a pop-up window after clicking **Create**. Then click **Save** to generate the certificate request.

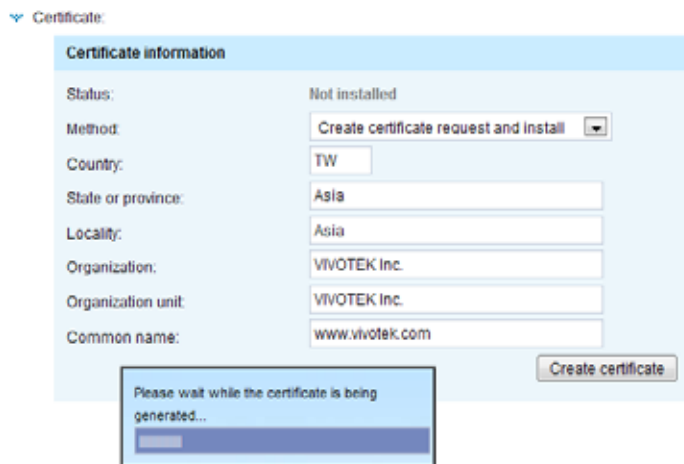

4. The Certificate request window will prompt.

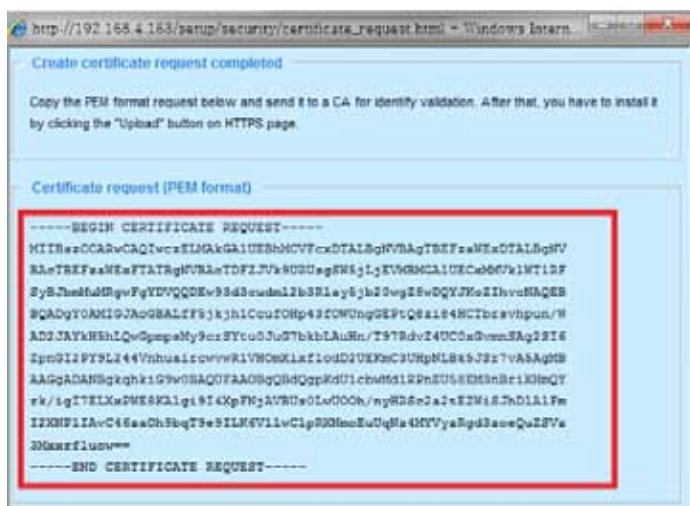

If you see the following Information bar, click **OK** and click on the Information bar at the top of the page to allow pop-ups.

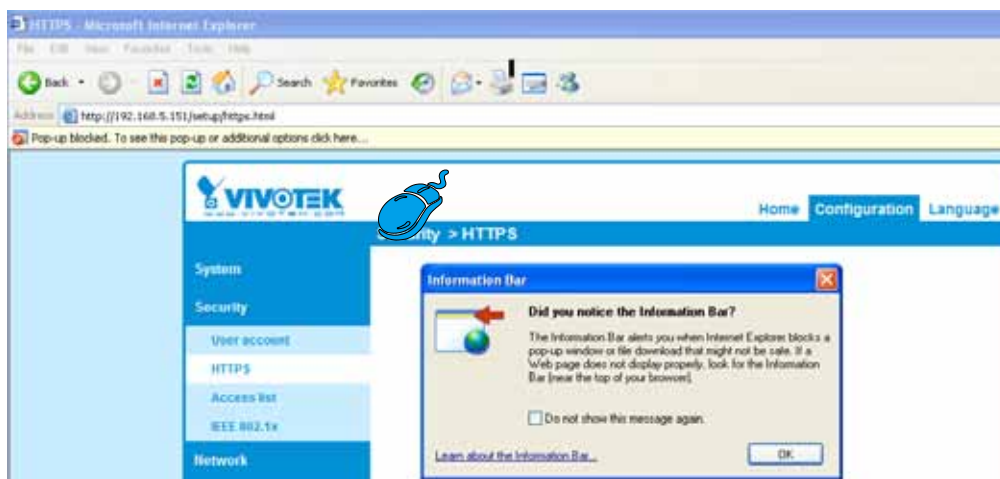

- Open a new edit, paste the certificate contents, and press ENTER at the end of the contents to add an empty line.

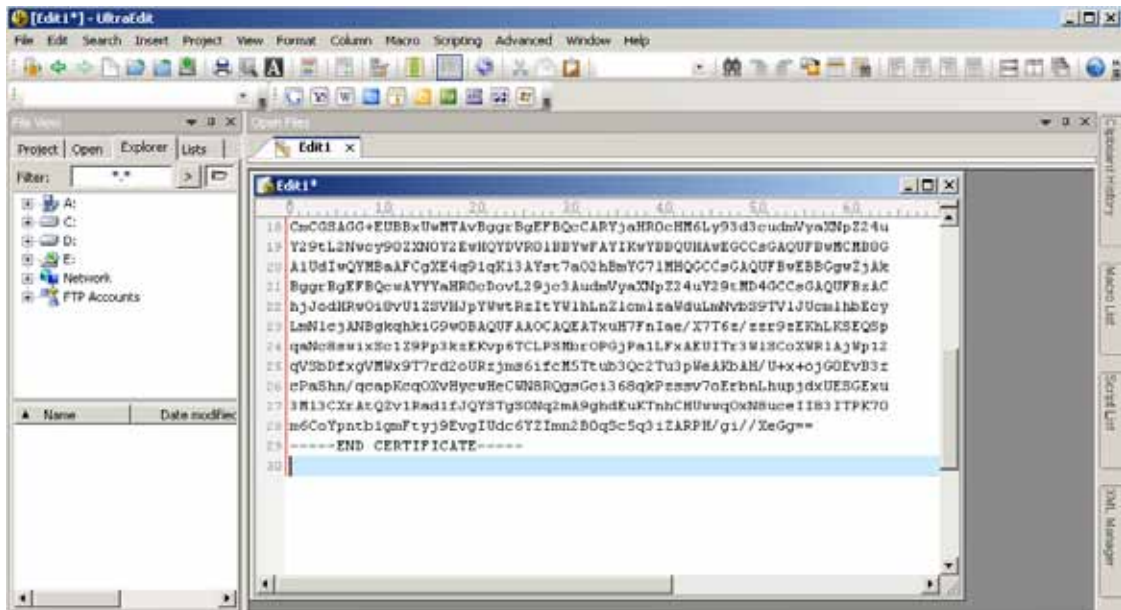

- Convert file format from DOS to UNIX. Open **File** menu > **Conversions** > **DOS to Unix**.

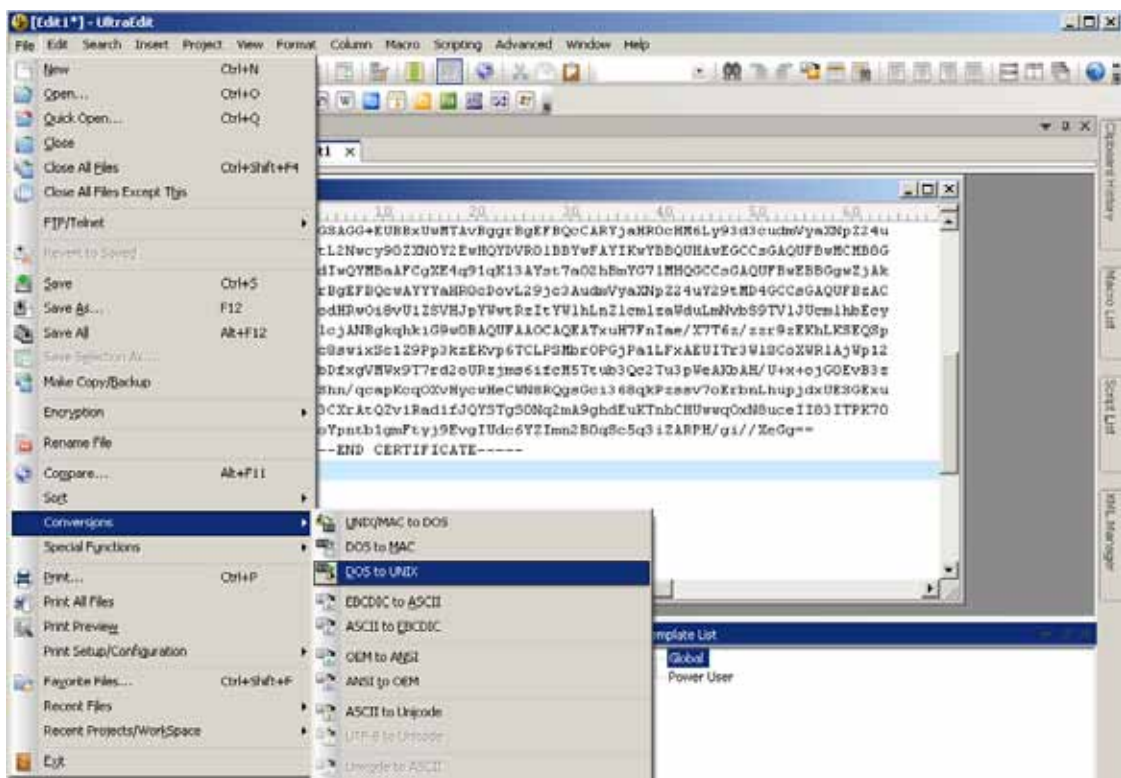

9. Save the edit using the “.crt” extension, using a file name like “CAcert.crt.”

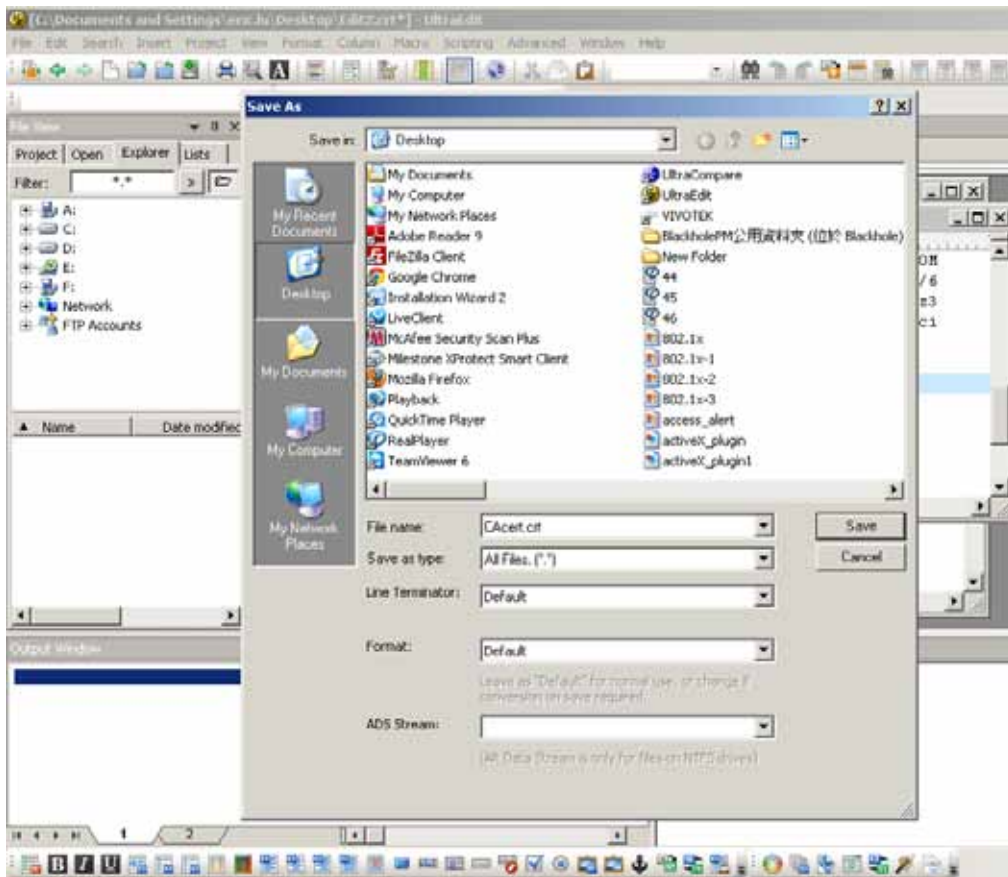

10. Return to the original firmware session, use the **Browse** button to locate the crt certificate file, and click **Upload** to enable the certification.

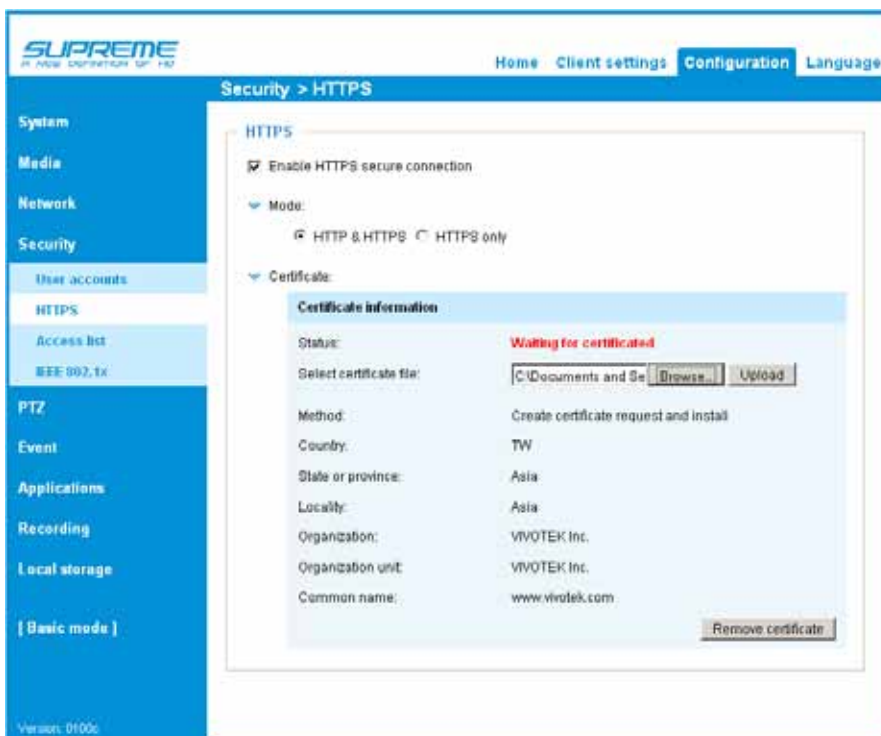

- When the certificate file is successfully loaded, its status will be stated as **Active**. Note that a certificate must have been created and installed before you can click on the **“Save”** button for the configuration to take effect.

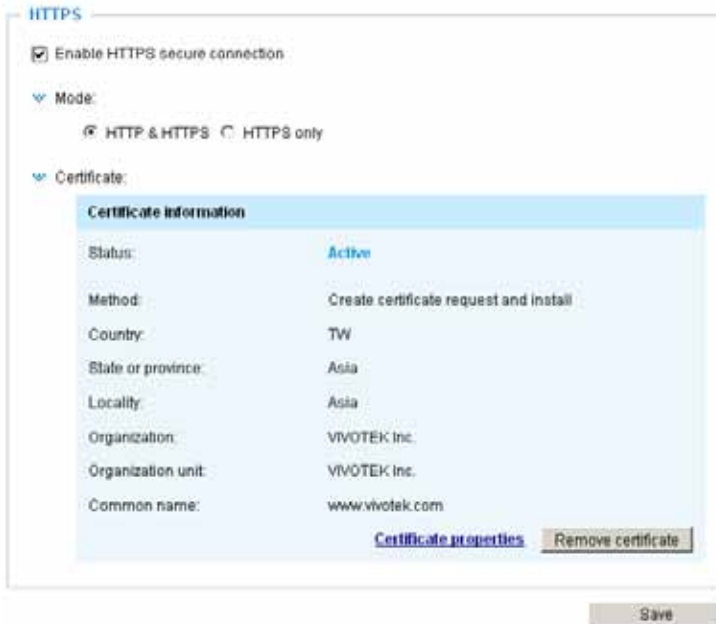

- To begin an encrypted HTTPS session, click **Home** to return to the main page. Change the URL address from **“http://”** to **“https://”** in the address bar and press **Enter** on your keyboard. Some Security Alert dialogs will pop up. Click **OK** or **Yes** to enable HTTPS.

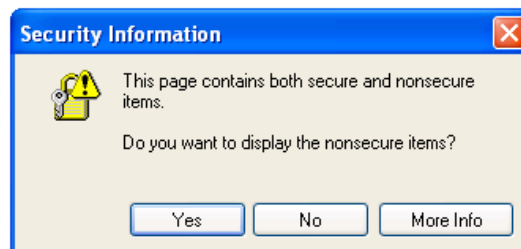
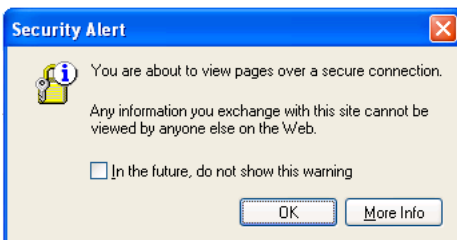

Security > Access List

This section explains how to control access permission by verifying the client PC's IP address.

General Settings



Maximum number of concurrent streaming connection(s) limited to: Simultaneous live viewing for 1~10 clients (including stream 1 to stream 3). The default value is 10. If you modify the value and click **Save**, all current connections will be disconnected and automatically attempt to re-link (IE Explorer or Quick Time Player).

View Information: Click this button to display the connection status window showing a list of the current connections. For example:

	IP address	Elapsed time	User ID
<input type="checkbox"/>	172.16.2.53	00:00:05	
<input type="checkbox"/>	192.168.4.104	01:49:35	

Refresh Add to deny list Disconnect Close

Note that only consoles that are currently displaying live streaming will be listed in the View Information list.

- IP address: Current connections to the Network Camera.
- Elapsed time: How much time the client has been at the webpage.
- User ID: If the administrator has set a password for the webpage, the clients have to enter a user name and password to access the live video. The user name will be displayed in the User ID column. If the administrator allows clients to link to the webpage without a user name and password, the User ID column will be empty.

There are some situations that allow clients access to the live video without a user name and password:

1. The administrator does not set up a root password. For more information about how to set up a root password and manage user accounts, please refer to Security > User account on page 113.
2. The administrator has set up a root password, but set **RTSP Authentication** to "disable". For more information about **RTSP Authentication**, please refer to RTSP Streaming on page 103.
3. The administrator has set up a root password, but allows anonymous viewing. For more information about **Allow Anonymous Viewing**, please refer to page 113.

- **Refresh:** Click this button to refresh all current connections.
- **Add to deny list:** You can select entries from the Connection Status list and add them to the Deny List to deny access. Please note that those checked connections will only be disconnected temporarily and will automatically try to re-link again (IE Explore or Quick Time Player). If you want to enable the denied list, please check **Enable access list filtering** and click **Save** in the first column.
- **Disconnect:** If you want to break off the current connections, please select them and click this button. Please note that those checked connections will only be disconnected temporarily and will automatically try to re-link again (IE Explore or Quick Time Player).

Filter

Enable access list filtering: Check this item and click **Save** if you want to enable the access list filtering function.

Filter type: Select **Allow** or **Deny** as the filter type. If you choose **Allow Type**, only those clients whose IP addresses are on the Access List below can access the Network Camera, and the others cannot. On the contrary, if you choose **Deny Type**, those clients whose IP addresses are on the Access List below will not be allowed to access the Network Camera, and the others can.



The screenshot shows a web interface for configuring filters. At the top, there is a checkbox labeled "Enable access list filtering". Below it, the "Filter type" is set to "Deny" (indicated by a selected radio button). There are two main sections: "IPv4 access list" and "IPv6 access list". Each section contains a large, empty rectangular area for listing IP addresses, with "Add" and "Delete" buttons positioned below each area.

Then you can **Add** a rule to the following Access List. Please note that the IPv6 access list column will not be displayed unless you enable IPv6 on the Network page. For more information about **IPv6 Settings**, please refer to Network > General settings on page 95 for detailed information.

There are three types of rules:

Single: This rule allows the user to add an IP address to the Allowed/Denied list.
For example:

Filter address

Rule:

IP address:

Network: This rule allows the user to assign a network address and corresponding subnet mask to the Allow/Deny List. The address and network mask are written in CIDR format.
For example:

Filter address

Rule:

Network address / Network mask: /

IP address range 192.168.2.x will be blocked.

If IPv6 filter is preferred, you will be prompted by the following window. Enter the IPv6 address and the two-digit prefix length to specify the range of IP addresses in your configuration.

Add IPv6 filter list

Filter address

Rule:

Network address / Network mask: /

Range: This rule allows the user to assign a range of IP addresses to the Allow/Deny List.
Note: This rule only applies to IPv4 addresses.
For example:

Filter address

Rule:

IP address - IP address: -

Administrator IP address

Always allow the IP address to access this device: You can check this item and add the Administrator’s IP address in this field to make sure the Administrator can always connect to the device.

Administrator IP address

Always allow the IP address to access this device

Security > IEEE 802.1X

Enable this function if your network environment uses IEEE 802.1x, which is a port-based network access control. The network devices, intermediary switch/access point/hub, and RADIUS server must support and enable 802.1x settings.

The 802.1x standard is designed to enhance the security of local area networks, which provides authentication to network devices (clients) attached to a network port (wired or wireless). If all certificates between client and server are verified, a point-to-point connection will be enabled; if authentication fails, access on that port will be prohibited. 802.1x utilizes an existing protocol, the Extensible Authentication Protocol (EAP), to facilitate communication.

- The components of a protected network with 802.1x authentication:



1. Supplicant: A client end user (camera), which requests authentication.
2. Authenticator (an access point or a switch): A “go between” which restricts unauthorized end users from communicating with the authentication server.
3. Authentication server (usually a RADIUS server): Checks the client certificate and decides whether to accept the end user’s access request.

- VIVOTEK Network Cameras support two types of EAP methods to perform authentication: **EAP-PEAP** and **EAP-TLS**.

Please follow the steps below to enable 802.1x settings:

1. Before connecting the Network Camera to the protected network with 802.1x, please apply a digital certificate from a Certificate Authority (i.e., your network administrator) which can be validated by a RADIUS server.
2. Connect the Network Camera to a PC or notebook outside of the protected LAN. Open the configuration page of the Network Camera as shown below. Select **EAP-PEAP** or **EAP-TLS** as the EAP method. In the following blanks, enter your ID and password issued by the CA, then upload related certificate(s).

IEEE 802.1x

Enable IEEE 802.1x

EAP method: EAP-PEAP ▼

Identity:

Password:

CA certificate:

Status: no file

IEEE 802.1x

Enable 802.1x

EAP method: EAP-TLS

Identity:

Private key password:

CA certificate:

Status: no file

client certificate:

Status: no file

Client private key:

Status: no file

3. When all settings are complete, move the Network Camera to the protected LAN by connecting it to an 802.1x enabled switch. The devices will then start the authentication automatically.

 **NOTE:**

► *The authentication process for 802.1x:*

1. *The Certificate Authority (CA) provides the required signed certificates to the Network Camera (the supplicant) and the RADIUS Server (the authentication server).*
2. *A Network Camera requests access to the protected LAN using 802.1X via a switch (the authenticator). The client offers its identity and client certificate, which is then forwarded by the switch to the RADIUS Server, which uses an algorithm to authenticate the Network Camera and returns an acceptance or rejection back to the switch.*
3. *The switch also forwards the RADIUS Server's certificate to the Network Camera.*
4. *Assuming all certificates are validated, the switch then changes the Network Camera's state to authorized and is allowed access to the protected network via a pre-configured port.*

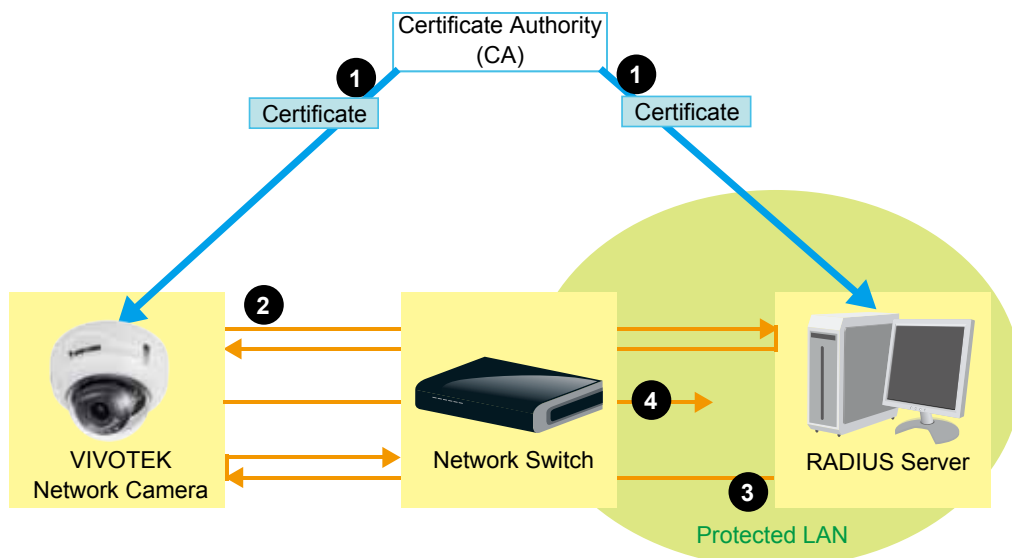

Security > Miscellaneous

The embedded TrendMicro utility provides the protection against Cross-Site Request Forgery. Cross-site request forgery is also known as one-click attack or session riding and is abbreviated as CSRF. CSRF is a type of malicious exploit of a website, in this case, the camera. Unauthorized commands are transmitted from a user that the web application trusts, using the mechanism of forging a trusted user's own request with a request containing his own cookies, etc. Different ways can be used for a malicious website to transmit such commands. They can be specially-crafted image tags, hidden forms, and JavaScript XMLHttpRequests. The malicious attack can occur without users' interaction or even knowing it.

Miscellaneous

Enable Cross-Site Request Forgery(CSRF) protection.

We strongly recommend not to disable this protection. Disabling this feature will expose your camera to risks.

Save

PTZ > PTZ settings

This section explains how to control the Network Camera's Pan/Tilt/Zoom operation.

Digital: Control the e-PTZ operation. Within a field of view, it allows users to quickly move the focus to a target area for close-up viewing without physically moving the camera.

Digital PTZ Operation (E-PTZ Operation)

The e-PTZ control settings section will be displayed as shown below:

The screenshot displays the 'Digital' PTZ settings page. At the top left, there is a 'Select stream: 1' dropdown. The main video window shows a street view with 'x1.8' zoom and a timestamp '2015/05/20 09:57:30'. To the right of the video are control buttons: 'Home', 'Zoom' (with '-' and '+'), and directional arrows. Below the video are three sections: 'Home location settings' with 'Set current position as home' and 'Restore home position to default' buttons; 'Preset and patrol settings' with a 'Name' field and 'Add preset location' button, and a table for 'Patrol locations' with columns for location names and 'Dwell time (sec)'; and 'Misc settings' with a checked 'Zoom factor display' checkbox. A 'Save' button is highlighted with a yellow box at the bottom right.

For e-PTZ related details, please refer to page 130.

Auto pan/patrol speed: Select the speed from 1~5 (slow/fast) to set up the Auto pan/patrol speed control.

Zoom factor display

If you check this item, the zoom indicator will be displayed on the home page when you zoom in/out the live viewing window as the picture shown on the next page.

When completed with the e-PTZ settings, click **Save** to enable the settings on this page.

Home page in the E-PTZ Mode



- The e-Preset Positions will also be displayed on the home page. Select one from the drop-down list, and the Network Camera will move to the selected position.
- If you have set up different preset positions for different streams, you can select one of the video streams to display its separate preset positions.

Global View

In addition to using the e-PTZ control panel, you can also use the mouse to drag or resize the floating frame to pan/tilt/zoom the viewing region. The live view window will also move to the viewing region accordingly.

Moving Instantly

If you check this item, the live view window will switch to the new viewing region instantly after you move the floating frame. If not selected, the process of moving from one position to another will be shown.

Click on Image

The e-PTZ function also supports "Click on Image". When you click on any point of the Global View Window or Live View Window, the viewing region will also move to that point.

Note that the "Click on Image" function only applies when you have configured a smaller "Region of Interest" out of the maximum output frame! e.g., an 800 x 600 region from out of the camera's maximum frame size.

Patrol button: Click this button, then the Network Camera will patrol among the selected preset positions continuously.

Patrol settings

You can select some preset positions for the Network Camera to patrol. Please follow the steps below to set up a patrol schedule:

1. Select the preset locations on the list, and click **>>**.
2. The selected preset locations will be displayed on the **Patrol locations** list.
3. Set the **Dwelling time** for the preset location during an auto patrol.
4. If you want to delete a preset location from the Patrol locations list, select it and click **Remove**.
5. Select a location and click **▲ ▼** to rearrange the patrol order.
6. Select patrol locations you want to save in the list and click **Save** to enable the patrol settings.
7. To implement the patrol schedule, please go to homepage and click on the **Patrol** button.

Digital

Select stream: 2 ▼

(TCP-V) 2018/3/20 09:57:30



▲
Home
▼

◀

▶

-
Zoom
+

Pan speed: 0 ▼

Tilt speed: 0 ▼

Zoom speed: 0 ▼

Auto pan/patrol speed: 1 ▼

Go to: -- Select one -- ▼

Home location settings

Set current position as home
Restore home position to default

Preset and patrol settings

Name: Add preset location

2

Select Preset Locations for Patrol **3**

1

User preset locations

- upper left
- left
- lower left
- center
- right

Remove
More

Patrol locations
Dwell time (sec)

- upper left 5
- left 5
- lower left 5
- center 5
- right 5

Remove
▲ ▼
More

4 **5**

Misc settings

Zoom factor display **6**

Save

**NOTE:**

- The Preset Positions will also be displayed on the Home page. Select one from the Go to menu, and the Network Camera will move to the selected preset position.
 - Click Patrol: The Network Camera will patrol along the selected positions repeatedly.
-

Event > Event settings

This section explains how to configure the Network Camera to respond to particular situations (event). A typical application is that when a motion is detected, the Network Camera sends buffered images to an FTP server or e-mail address as notifications. Click on **Help**, there is an illustration shown in the pop-up window explaining that an event can be triggered by many sources, such as motion detection or external digital input devices. When an event is triggered, you can specify what type of action that will be performed. You can configure the Network Camera to send snapshots or videos to your email address or FTP site.

Event

Name	Status	Sun	Mon	Tue	Wed	Thu	Fri	Sat	Time	Trigger
------	--------	-----	-----	-----	-----	-----	-----	-----	------	---------

[Help](#)

The diagram shows a flow from 'Event Trigger' to 'Action (What to do)'. Under 'Event Trigger', examples include Motion detection, Periodically, Digital input, and System boot. The 'Action (What to do)' branches into two categories: 'Media (What to send)' and 'Server (Where to send)'. Under 'Media (What to send)', examples include Snapshot, Video Clip, and System log. Under 'Server (Where to send)', examples include Email, FTP, HTTP Server, and Network storage.

Event

To configure an event with reactive measures such as recording video or snapshots, it is necessary to configure the server and media settings so that the Network Camera will know what action to take (such as which server to send the media files to) when a trigger is activated. An event is an action initiated by a user-defined trigger source. In the **Event** column, click **Add** to open the event settings window. Here you can arrange three elements -- Schedule, Trigger, and Action to set an event. A total of 3 event settings can be configured.

Event

Name	Status	Sun	Mon	Tue	Wed	Thu	Fri	Sat	Time	Trigger
------	--------	-----	-----	-----	-----	-----	-----	-----	------	---------

[Help](#)

The screenshot shows the 'Event Settings' window. It includes an 'Event name' field, an 'Enable this event' checkbox, a 'Priority' dropdown menu, and a field for 'Detect next motion detection or digital input after' with a value of 10 seconds. The 'Event Schedule' section has checkboxes for all days of the week (Sun, Mon, Tue, Wed, Thu, Fri, Sat) and a 'Time' section with radio buttons for 'Always' and 'From 00:00 to 24:00 [hh:mm]'. A flowchart on the left side of the window highlights three steps: '1. Schedule', '2. Trigger', and '3. Action'. At the bottom, there are 'Save event' and 'Close' buttons.

- Event name: Enter a name for the event setting.
- Enable this event: Select this checkbox to enable the event setting.
- Priority: Select the relative importance of this event (High, Normal, or Low). Events with a higher priority setting will be executed first.
- Detect next motion detection or digital input after seconds: Enter the duration in seconds to pause motion detection after a motion is detected. This can prevent event-related actions to take place too frequently.

1. Schedule

Specify the period of time during which the event trigger will take effect. Please select the days of the week and the time in a day (in 24-hr time format) for the event triggering schedule. For example, you may prefer an event to be triggered only during the off-office hours.

2. Trigger

This is the cause or stimulus which defines when to trigger the Network Camera. The trigger source can be configured to use the Network Camera's built-in motion detection mechanism or external digital input devices.

There are several choices of trigger sources as shown on the next page. Select the item to display the detailed configuration options.

- Video motion detection

This option makes use of the built-in motion detection mechanism as a trigger source. To enable this function, you need to configure a Motion Detection Window first. For more information, please refer to Motion Detection on page 146 for details.

Video motion detection

Normal: door

Profile: hallway

Note: Please configure Motion detection first

- Periodically

This option allows the Network Camera to trigger periodically for every other defined minute. Up to 999 minutes are allowed.

Periodically

Trigger every other minutes

- System boot

This option triggers the Network Camera when the power to the Network Camera is disconnected and re-connected.

- Recording notify

This option allows the Network Camera to trigger when the recording disk is full or when recording starts to overwrite older data.

- Audio detection

A preset threshold can be configured with an external microphone as the trigger to system event. The triggering condition can be an input exceeding or falling below a threshold. Audio detection can take place as a complement to motion detection or as a method to detect activities not covered by the camera's view.

■ Camera tampering detection

This option allows the Network Camera to trigger when the camera detects that it is being tampered with. To enable this function, you need to configure the Tampering Detection option first. Please refer to page 148 for detailed information.

- Camera tampering detection
 - Tampering detection Too dark Too bright Too blurry

Note: Please configure [Camera tampering detection](#) first

■ Manual Triggers

This option allows users to enable event triggers manually by clicking the on/off button on the homepage. Please configure 1 to 3 associated events before using this function.

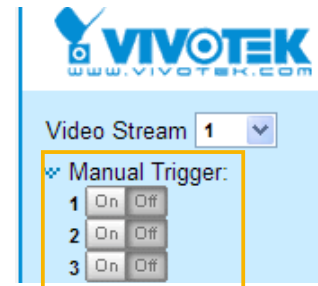

■ Shock detection

A shock accelerometer comes with the camera. If impact to the camera occurs, such as someone tries to destroy the camera, the impact can be detected and reported. The Shock detection configuration is found in Configuration > Applications > Shock detection.

■ VADP

It is presumed that you already uploaded and enabled the VADP modules before you can associate VADP triggers with an Event setting.

Click on the Set VADP Trigger button to open the VADP setup menu. The triggering conditions available with 3rd-party software modules known as VADP will be listed. Use the arrow buttons to select these triggers. Users may implant these modules for different purposes such as triggering motion detection, or applications related to video analysis, etc. Please refer to page 152 for the configuration options with VADP modules.

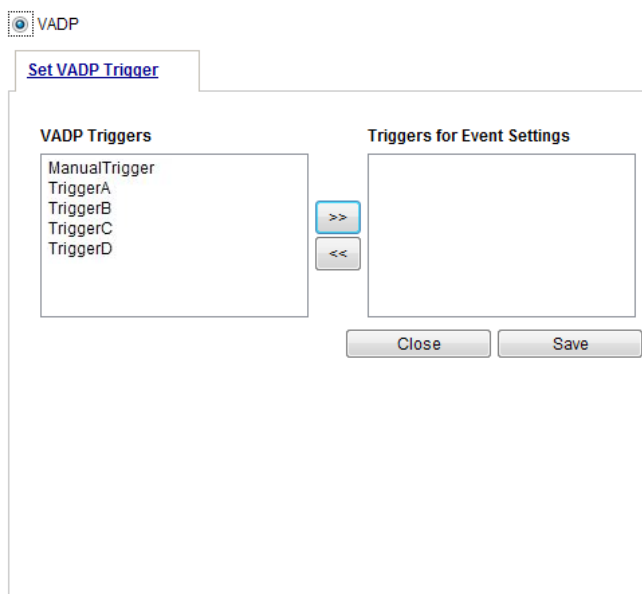

Once the triggers are configured, they will be listed under the VADP option.

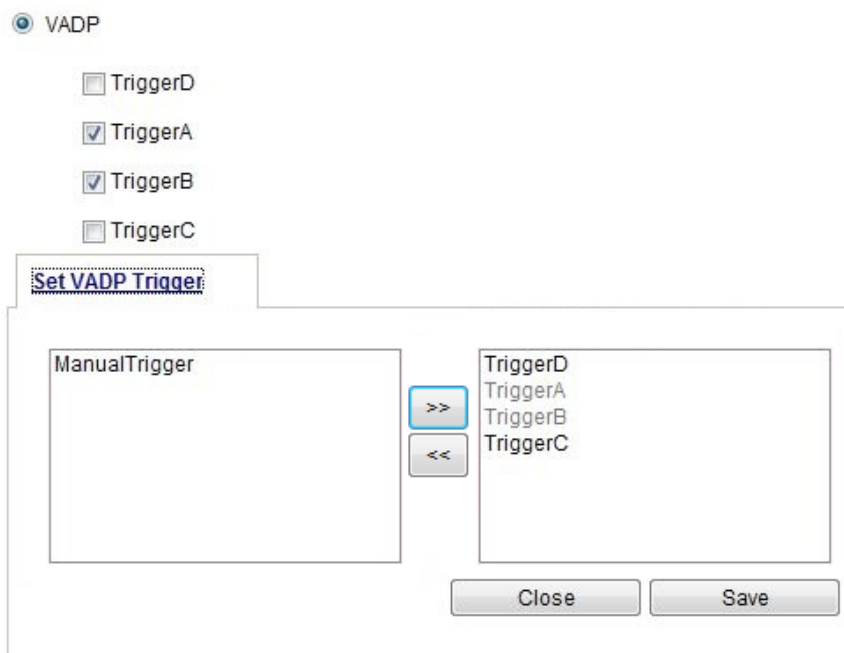

3. Action

Define the actions to be performed by the Network Camera when a trigger is activated.

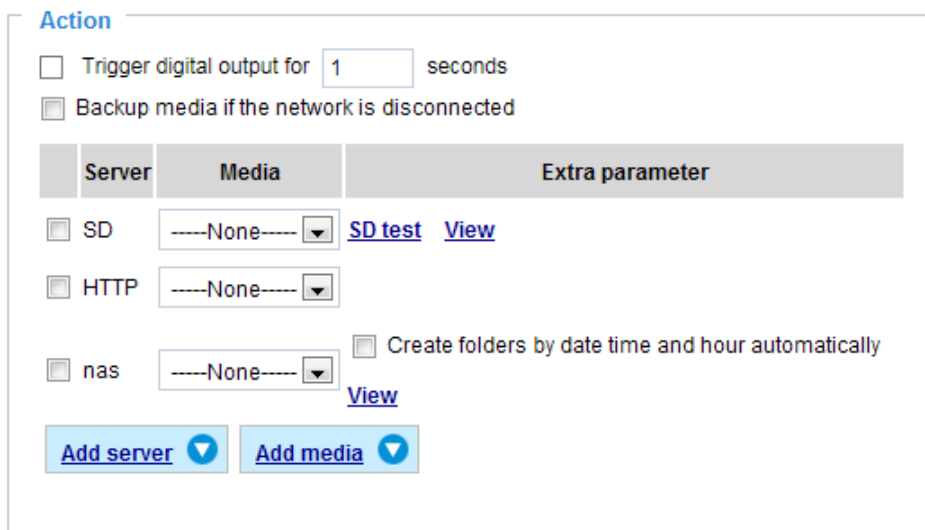

- Backup media if the network is disconnected

Select this option to backup media file on SD card if the network is disconnected. This function will only be displayed after you set up a network storage (NAS). The media to back up can include snapshot images, video, or system logs depending on your event settings.

Add server

It is necessary to configure the server and media settings so that the Network Camera will know what action to take (such as which server to send the media files to) when a trigger is activated. Click **Add server** to open the server setting window. You can specify where the notification messages are sent to when a trigger is activated. A total of 5 server settings can be configured.

There are four choices of server types available: Email, FTP, HTTP, and Network storage. Select the item to display the detailed configuration options. You can configure either one or all of them.

Server type - Email

Select to send the media files via email when a trigger is activated.

- Server name: Enter a name for the server setting.
- Sender email address: Enter the email address of the sender.
- Recipient email address: Enter the email address of the recipient.
- Server address: Enter the domain name or IP address of the email server.
- User name: Enter the user name of the email account if necessary.
- Password: Enter the password of the email account if necessary.
- Server port: The default mail server port is set to 25. You can also manually set another port.

If your SMTP server requires a secure connection (SSL), select **This server requires a secure connection (SSL)**.

To verify if the email settings are correctly configured, click **Test**. The result will be shown in a pop-up window. If successful, you will also receive an email indicating the result.



Click **Save server** to enable the settings.

Note that after you configure the first event server, the new event server will automatically display on the Server list. If you wish to add other server options, click **Add server**.



Server type - FTP

Select to send the media files to an FTP server when a trigger is activated.

Server name:

Server Type

Email

FTP

Server address:

Server port:

User name:

Password:

FTP folder name:

Passive mode

HTTP

Network storage

- Server name: Enter a name for the server setting.
- Server address: Enter the domain name or IP address of the FTP server.
- Server port: By default, the FTP server port is set to 21. It can also be assigned to another port number between 1025 and 65535.
- User name: Enter the login name of the FTP account.
- Password: Enter the password of the FTP account.
- FTP folder name
Enter the folder where the media files will be placed. If the folder name does not exist, the Network Camera will automatically create one on the FTP server.

■ **Passive mode**

Most firewalls do not accept new connections initiated from external requests. If the FTP server supports passive mode, select this option to enable passive mode FTP and allow data transmission to pass through the firewall. The firmware default has the Passive mode checkbox selected.

To verify if the FTP settings are correctly configured, click **Test**. The result will be shown in a pop-up window as shown below. If successful, you will also receive a test.txt file on the FTP server.

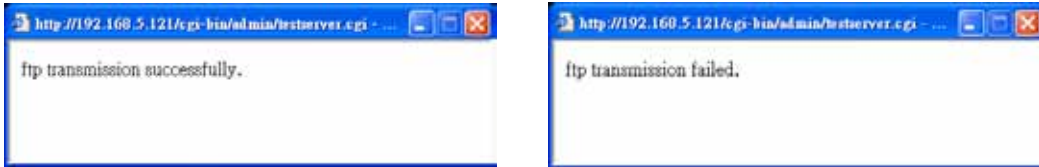

Click **Save server** to enable the settings.

Server type - HTTP

Select to send the media files to an HTTP server when a trigger is activated.

- **Server name:** Enter a name for the server setting.
- **URL:** Enter the URL of the HTTP server.
- **User name:** Enter the user name if necessary.
- **Password:** Enter the password if necessary.

To verify if the HTTP settings are correctly configured, click **Test**. The result will be shown in a pop-up window as shown below. If successful, you will receive a test.txt file on the HTTP server.



Click **Save server** to enable the settings.

Network storage:

Select to send the media files to a networked storage when a trigger is activated. Please refer to **NAS server** on page 158 for details. Note that only one NAS server can be configured.

Click **Save server** to enable the settings.

Action

Trigger digital output for seconds

Backup media if the network is disconnected

Server	Media	Extra parameter
<input type="checkbox"/> SD	----None----	SD test View
<input type="checkbox"/> Email	----None----	
<input type="checkbox"/> FTP	----None----	
<input type="checkbox"/> HTTP	----None----	
<input type="checkbox"/> NAS	----None----	<input type="checkbox"/> Create folders by date time and hour automatically View

- **SD Test:** Click to test your SD card. The system will display a message indicating the result as a success or a failure. If you want to use your SD card for local storage, please format it before use. Please refer to page 141 for detailed information.
- **View:** Click this button to open a file list window. This function is only for SD card and Network Storage. If you click the View button for an SD card, a Local storage page will prompt so that you can manage the recorded files on SD card. For more information about Local storage, please refer to page 160. If you click the View button for a Network storage, a file directory window will prompt for you to view recorded data on Network storage. For detailed illustration, please refer to the next page.
- **Create folders by date, time, and hour automatically:** If you select this item, the system will automatically create folders by the date when video footages are stored onto the networked storage.

The following is an example of a file destination with video clips:

<input type="checkbox"/>	▶	20190120	
<input type="checkbox"/>	▶	20190121	
<input type="checkbox"/>	▶	20190122	

The format is: YYYYMMDD
Click to open the directory

Click to delete selected items

Click to delete all recorded data

Click [20190120](#) to open the directory:

The format is: HH (24r)

Click to open the file list for that hour

< 07 08 09 10 11 12 13 14 15 16 17 >

	file name	size	date	time
<input type="checkbox"/>	Recording1 58.mp4	2526004	2019/01/20	07:58:28
<input type="checkbox"/>	Recording1 59.mp4	2563536	2019/01/20	07:59:28

Click to delete selected items

Click to go back to the previous level of the directory

Click to delete all recorded data

< 07 08 09 10 11 12 13 14 15 16 17 >

	file name	size	date	time
<input type="checkbox"/>	Recording1 58.mp4	2526004	2019/01/20	07:58:28
<input type="checkbox"/>	Recording1 59.mp4	2563536	2019/01/20	07:59:28

The format is: File name prefix + Minute (mm)

You can set up the file name prefix on Add media page. Please refer to next page for detailed information.

Add media

Click **Add media** to open the media setting window. You can specify the type of media that will be sent when a trigger is activated. A total of 5 media settings can be configured. There are three choices of media types available: Snapshot, Video Clip, and System log. Select the item to display the detailed configuration options. You can configure either one or all of them.

Media type - Snapshot

Select to send snapshots when a trigger is activated.

- Media name: Enter a name for the media setting.
- Source: Select to take snapshots from any of the video streams.
- Send pre-event images
The Network Camera has a buffer to temporarily hold data up to a certain limit. Enter a number to decide how many images to capture before a trigger is activated. Up to 7 images can be generated.
- Send post-event images
Enter a number to decide how many images to capture after a trigger is activated. Up to 7 images can be generated.

For example, if both the Send pre-event images and Send post-event images are set to 7, a total of 15 images can be generated after a trigger is activated.

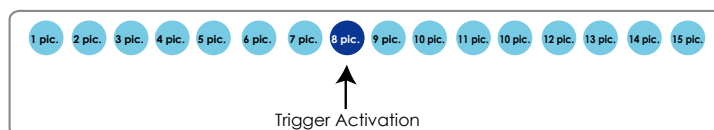

- File name prefix
Enter the text that will be appended to the front of the file name.

- Add date and time suffix to the file name
Select this option to add a date/time suffix to the file name.
For example:

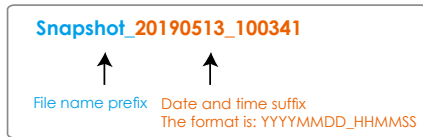

Click **Save media** to enable the settings.

Note that after you set up the first media server, a new column for media server will automatically display on the Media list. If you wish to add more media options, click **Add media**.

Media type - Video clip

Select to send video clips when a trigger is activated.

- Media name: Enter a name for the media setting.
- Source: Select a video stream as the source of video clip.
- Pre-event recording
The Network Camera has a buffer to temporarily hold data up to a certain limit. Enter a number to decide the duration of recording before a trigger is activated. Up to 9 seconds can be set.
- Maximum duration
Specify the maximum recording duration in seconds. The duration can be up to 10 seconds. For example, if pre-event recording is set to five seconds and the maximum duration is set to ten seconds, the Network Camera continues to record for another 4 seconds after a trigger is activated.

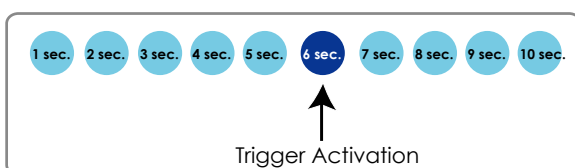

- **Maximum file size**
Specify the maximum file size allowed. Some users may need to stitch the video clips together when searching and packing up forensic evidence.
- **File name prefix**
Enter the text that will be appended to the front of the file name.
For example:



Click **Save media** to enable the settings.

Media type - System log

Select to send a system log when a trigger is activated.

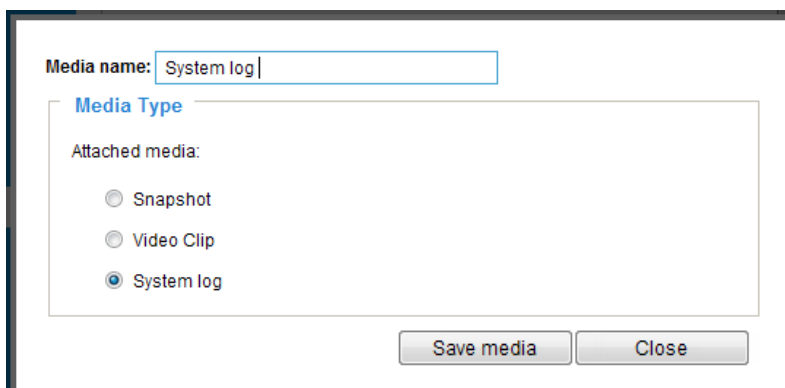

Click **Save media** to enable the settings, then click **Close** to exit the page.

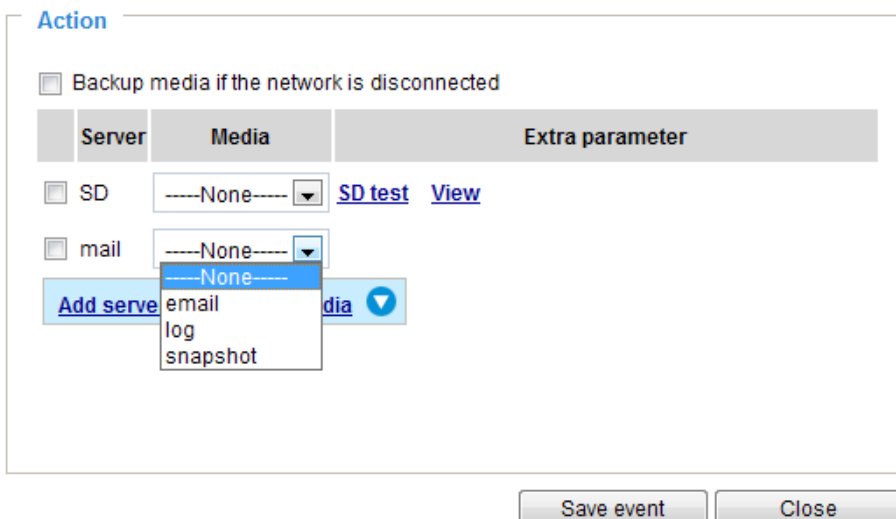

In the Event settings column, the Servers and Medias you configured will be listed; please make sure the Event -> Status is indicated as **ON**, in order to enable the event triggering action.

When completed, click the **Save event** button to enable the settings and click **Close** to exit Event Settings page. The new Event / Server settings / Media will appear in the event drop-down list on the Event setting page.

Please see the example of the Event setting page below:

Event

Name	Status	Sun	Mon	Tue	Wed	Thu	Fri	Sat	Time	Trigger	
event1	ON	V	V	V	V	V	V	V	00:00~24:00	seq	<input type="button" value="Delete"/>

[Help](#)

Server settings

Name	Type	Address/Location	
HTTP	http	http://192.168.5.10	<input type="button" value="Delete"/>

Media

Available memory space: 13000KB

Name	Type	
Snapshot	snapshot	<input type="button" value="Delete"/>
Video clip	videoclip	<input type="button" value="Delete"/>
System log	systemlog	<input type="button" value="Delete"/>

Customized script

Name	Date	Time
------	------	------

When the Event Status is **ON**, the event configuration above is triggered by motion detection, the Network Camera will automatically send snapshots via e-mail.

If you want to stop the event trigger, you can click on the **ON** button to turn it to **OFF** status or click the **Delete** button to remove the event setting.

To remove a server setting from the list, select a server name from the drop-down list and click **Delete**. Note that you can only delete a server setting when it is not applied in an existing event setting.

To remove a media setting from the list, select a media name from the drop-down list and click **Delete**. Note that you can only delete a media setting when it is not applied in an existing event setting.

Customized Script

This function allows you to upload a sample script (.xml file) to the camera, which will save your time on configuring the settings. Please note that there is a limited number of customized scripts you can upload; if the current amount of customized scripts has reached the limit, an alert message will prompt. If you need more information, please contact VIVOTEK technical support.

Customized Script

Name	Date	Time
User1	20190213	18:13:46
User2	20190213	18:11:32

Click to upload a file

```

<?xml version="1.0" encoding="UTF-8"?>
<eventmgr version="0102">
  <mgprocess></mgprocess>
  <!-- from 08:30:00-20:30:00 on Monday to Friday every week -->
  <schedule id="0">
    <duration>
      <weekdays>1-5</weekdays>
      <time>08:30:00-20:30:00</time>
    </duration>
  </schedule>
  <!-- Motion -->
  <motion condition="0">
    <status id="0"><trigger/></status>
    <status id="1"><trigger/></status>
  </motion>
  <event id="0">
    <description>Mail system log to email address</description>
    <condition></condition>
    <scheduleid></scheduleid>
    <delay>0</delay>
    <!-- users can send email with title "Notice" to recipient pudding.yang@vivotek.com. The body of mail is the log messages -->
    <process>
      /usr/bin/empollent -s "Motion" -f IP"193@vivotek.com -b /var/log/messages -S ma.vivotek.tw -
      M S pudding.yang@vivotek.com
    </process>
    <priority>0</priority>
  </event>
</eventmgr>
                
```

Click to modify the script online

Applications > Motion detection

The camera comes with a Smart Motion Detection utility as its pre-loaded VCA package. Please refer to its User Guide for more information:

http://download.vivotek.com/downloadfile/solutions/vadp/smart-motion-detection-manual_en.pdf.

Click on Configuration > Applications > Motion detection. The Smart Motion utility will be automatically started.

If Human detection is applied, make sure you measured the height of your camera at the installation site. It is important for a correct video analysis. You should enter the installation height in the Motion detection Settings page.

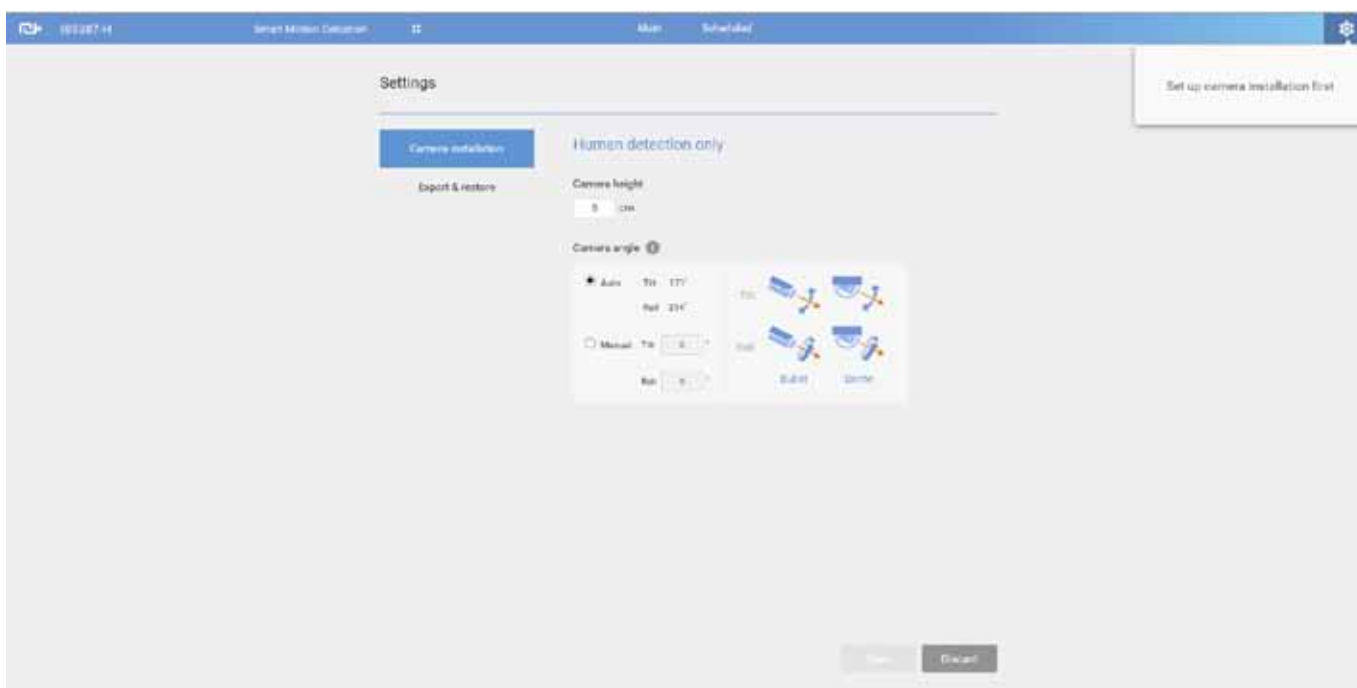
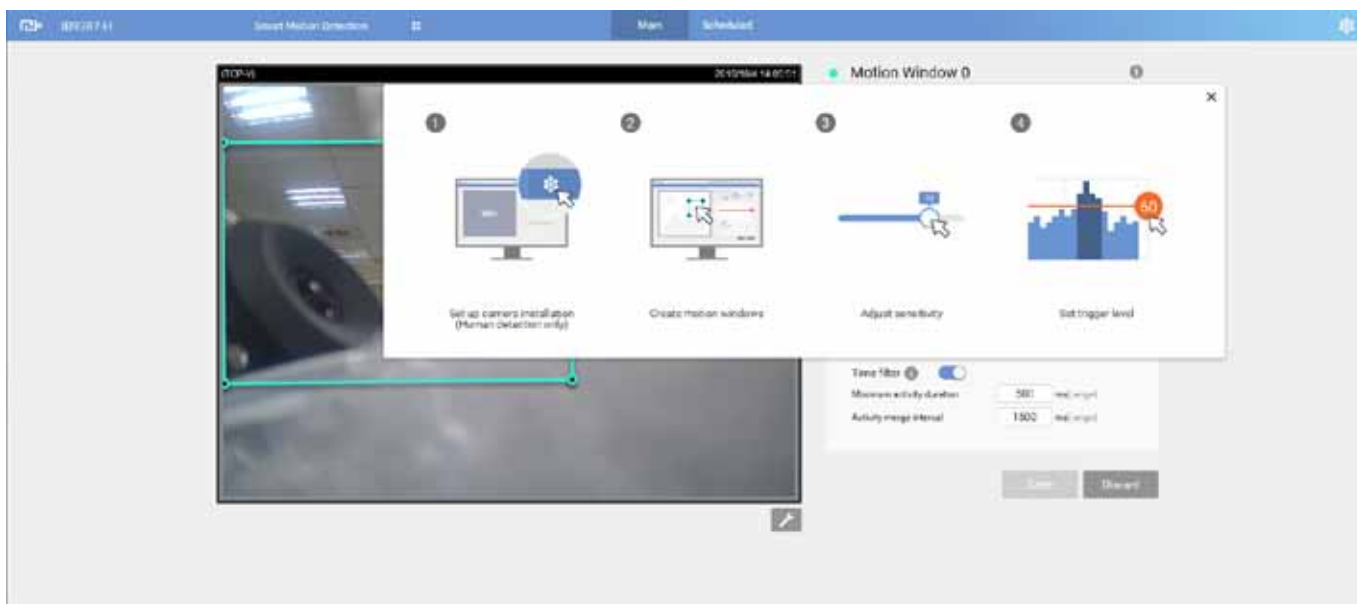

Applications > Smart VCA

Smart VCA provides the following features:

[Intrusion detection](#), [Loitering detection](#), [Missing object detection](#), [Unattended Object detection](#), [Line Crossing detection](#), and [Face detection](#).

Please refer to Smart VCA's user documentation for more information.

Click on Configuration > Applications > Smart VCA. The Smart VCA utility will be automatically started. The Smart Motion detection and Smart VCA share the same utility window.

If Smart VCA is applied, make sure you measured the height of your camera at the installation site. It is important for a correct video analysis. You should enter the installation height in the Smart VCA Settings page.

Applications > Tampering detection

This section explains how to set up camera tamper detection. With tamper detection, the camera is capable of detecting incidents such as **redirection**, **blocking or defocusing**, or even **spray paint**.

Camera tampering detection

Tampering detection

Trigger duration seconds [10~600]

Trigger threshold [0~100]

Image too dark detection

Trigger duration seconds [1~10]

Trigger threshold [0~100]

Image too bright detection

Trigger duration seconds [1~10]

Trigger threshold [0~100]

Image too blurry detection

Trigger duration seconds [1~10]

Trigger threshold [0~100]

Please follow the steps below to set up the camera tamper detection function:

1. Click to select the checkbox before tampering conditions: Tampering detection, Image too dark, Image too bright, and Image too blurry. Enter the tamper trigger duration. (10 sec. ~ 10 min.). The duration specifies the set of time before the tampering is considered as a real alarm. This helps avoid false alarms by short-lived changes.

The tamper alarm will be triggered only when the tampering factor (the difference between current frame and pre-saved background) exceeds the trigger threshold. Conditions such as image too dark, too bright, or too blurry (defocused) can also be configured as tampering conditions. The Trigger threshold determines how sensitive your is tamper detection setting. Lower the threshold number, easier to trigger.

Too bright: shining a flash light. The average lighting level of the scene is taken into consideration.

Too dark: covering the objective or spraying paint.

Too blurry: blurry scene can be the result of strong interference on the device, such as EMI interference.

2. You can configure Tampering Detection as a trigger element to the proactive event configurations in **Event -> Event settings -> Trigger**. For example, when the camera is tampered with, camera can be configured to send the pre- and post-event video clips to a networked storage device. Please refer to page 133 for detailed information.

Applications > Audio detection

Audio detection, along with video motion detection, is applicable in the following scenarios:

1. Detection of activities not covered by camera view, e.g., a loud input by gun shots or breaking a door/window.
2. A usually noisy environment, such as a factory, suddenly becomes quiet due to a breakdown of machines.
3. A PTZ camera can be directed to turn to a preset point by the occurrence of audio events.
4. Dark environments where video motion detection may not function well.

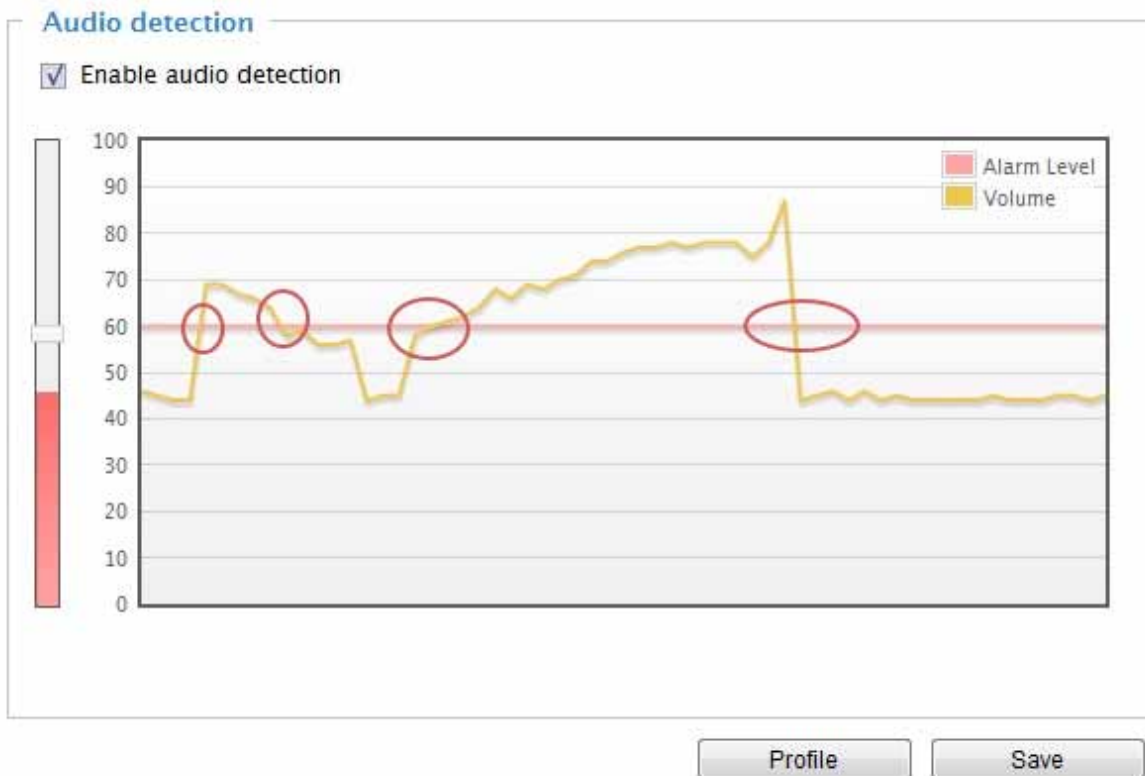

The red circles indicate where the audio alarms can be triggered when breaching or falling below the preset threshold.

How to configure Audio detection:

1. Once the Audio detection window is opened, the current sound input will be interactively indicated by a fluctuating yellow wave diagram.
2. Use a mouse click to drag the Alarm level tab to a preferred location on the slide bar.
3. Select the "Enable audio detection" checkbox and click Save to enable the feature.

NOTE:

1. Note that the volume numbers (0~100) on the side of wave diagram does not represent decibel (dB). Sound intensity level has already been mapped to preset values. You can, however, use the real-world inputs at your installation site that are shown on the wave diagram to configure an alarm level.
2. To configure this feature, you must not mute the audio in **Configuration > Media > Audio**. The default of the camera can be muted due to the lack of an internal microphone. An external microphone is provided by users.

You can use the **Profile** window to configure a different Audio detection setting. For example, a place can be noisy in the day time and become very quiet in the night.

1. Click on the **Enable this profile** checkbox. Once the Audio detection window is opened, the current sound input will be interactively indicated by a fluctuating yellow wave diagram.
2. Use a mouse click to drag the **Alarm level** tab to a preferred location on the slide bar.
3. Select the **Day**, **Night**, or **Schedule** mode check circles. You may also manually configure a period of time during which this profile will take effect.
4. Click **Save** and then click **Close** to complete your configuration.

>Audio detection profile settings

Audio detection

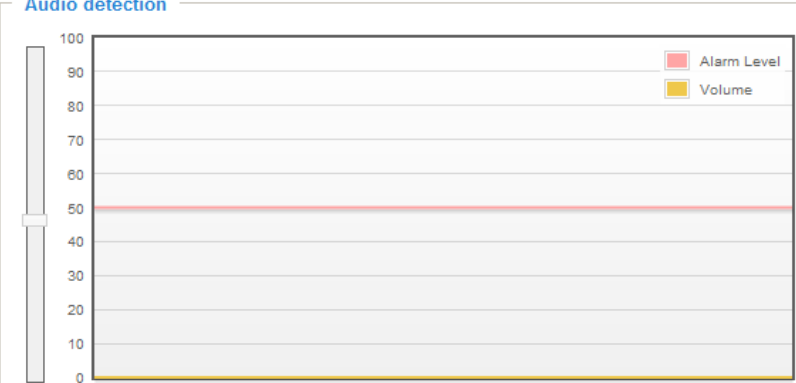

The graph displays two data series: 'Alarm Level' (red horizontal line) and 'Volume' (yellow fluctuating wave). The y-axis ranges from 0 to 100. The Alarm Level is currently set at 50, and the Volume is near 0.

General settings

Enable this profile

This profile is applied to:

Day mode

Night mode

Schedule mode

From to [hh:mm]



IMPORTANT:

- If the Alarm level and the received volume are set within a range of 20% on the wave diagram, frequent alarms will be triggered. It is recommended to set the Alarm level farther apart from the detected sound level.
- To configure and enable this feature, you **must not** configure video stream #1 into **Motion JPEG**. If an external microphone input is connected and recording of audio stream is preferred, audio stream is transmitted between camera and viewer/recording station **along with stream #1**.
- Refer to page 94 for Audio settings, and page 83 for video streaming settings.

Applications > Shock detection

The camera comes with a shock accelerometer. The shock sensor can detect impacts to the camera. For example, when a person deliberately tries to destroy the camera, the camera can report the event to the administrator.

Normally, a 5kgm impact can cause the detected impact level to surge to 50% on the scale. Configure the Alarm Level to a preferred percentage on the chart. Click the **Enable shock detector** checkbox and click **Save** to complete the configuration.

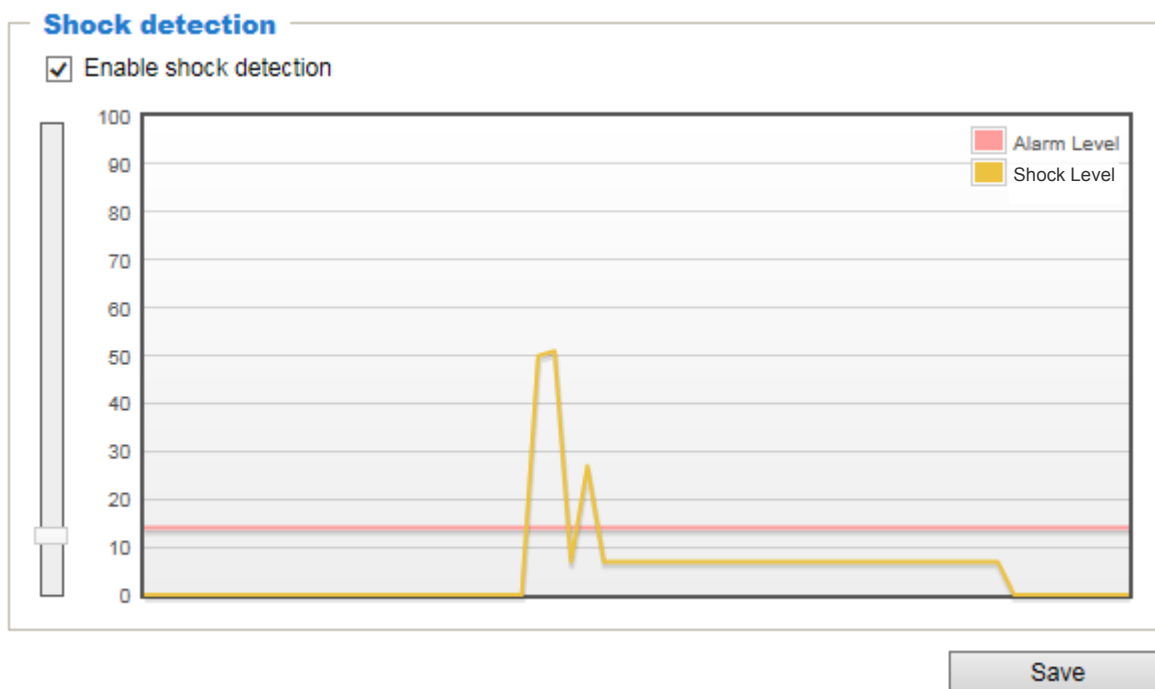

You should then go to Event settings to configure the shock detection as a triggering source. See page 131 for Event configuration.

The measurement range of the sensor is $\pm 16G$.

For every one G force ($g = 9.8 \text{ m/s}^2$) perceived, the sensor acquires a reading of 512.

The value acquired by a 2 G acceleration will look like the following:

$$512 * 2 / 16 = 64$$

Suppose that all 3-axis readings are equal (for simplicity reasons only), the shock level shown on the Shock detection chart will be $(64 + 64 + 64) * 100 / 1024 = 18.75$.

Applications > Package management - a.k.a., VADP (VIVOTEK Application Development Platform)

The camera comes embedded with the Smart Motion Detection feature. The Smart Motion detection, with Human detection and tunable time filter, can eliminate the defects of traditional motion detection and facilitate the configuration at a surveillance site.

To learn more about this feature, download its User Guide in:

http://download.vivotek.com/downloadfile/solutions/vadp/smart-motion-detection-manual_en.pdf

Upload package

Save to SD card

Select file

Resource status

▼ Storage status:

storage_size:	10240 KBytes	Free size:	10240 KBytes
---------------	--------------	------------	--------------

▼ SD card status: Detached

Total size:	0 KBytes	Free size:	0 KBytes
Used size:	0 KBytes	Use (%):	0 %

▼ Memory status:

Total size:	24576 KBytes	Free size:	24576 KBytes
-------------	--------------	------------	--------------

Package list

Module name	Vendor	Version	Status	License
<input type="button" value="Backup"/>	<input type="button" value="Reload"/>	<input type="button" value="Restore"/>	<input type="button" value="Start"/>	<input type="button" value="Stop"/>

Users can store and execute VIVOTEK's or 3rd-party software modules onto the camera's flash memory or SD card. These software modules can apply in video analysis for intelligent video applications such as license plate recognition, object counting, or as an agent for edge recording, etc.

- Once the software package is successfully uploaded, the module configuration (vadp.xml) information is displayed. When uploading a module, the camera will examine whether the module fits the predefined VADP requirements. Please contact our technical support or the vendor of your 3rd-party module for the parameters contained within.
- Users can also run VIVOTEK's VADP packages as a means to access updated functionality instead of replacing the entire firmware.
- Note that for some cameras the flash is too small to hold VADP packages. These cameras will have its "Save to SD card" checkbox selected and grayed-out for all time.
- The file system of SD card (FAT32) does not support soft (symbolic) link. It will return failure if your module tries to create soft links on SD card.



To utilize a software module, acquire the software package and click **Browse** and **Upload** buttons. The screen message for a successful upload is shown below:

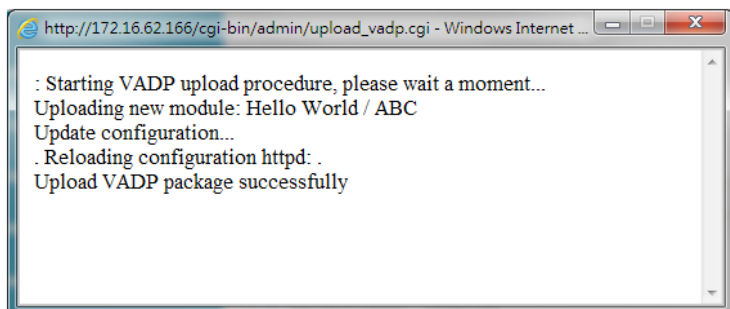

To start a module, select the checkcircle in front, and click the **Start** button.

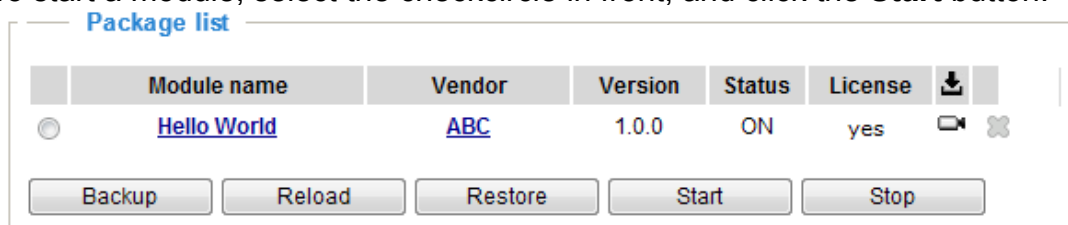

If you should need to remove a module, select the checkcircle in front and then click the **Stop** button. By then the module status will become **OFF**, and the **X** button will appear at the end of the row. Click on the **X** button to remove an existing module.



When prompted by a confirm message, Click **Yes** to proceed.

Note that the actual memory consumed while operating the module will be indicated on the **Memory status** field. This helps determine whether a running module has consumed too much of system resources.

On the License page, register and activate the license for using VIVOTEK's VADP modules. You should acquire the license key elsewhere, and manually upload to the network camera.

Follow the onscreen instruction on VIVOTEK's website for the registration procedure.

Status License

Manual License

To receive a license key for VADP application, go to <http://www.vivotek.com> and join the WTK member. This device's VADP number is:

`BbM79RE=OdGu1PIUEqJRFgc6sacoRs7g4PXl`

Select file No file selected.

Recording > Recording settings

This section explains how to configure the recording settings for the Network Camera.

Recording Settings

Insert your SD card and click here to test

Recording settings

Name	Status	Sun	Mon	Tue	Wed	Thu	Fri	Sat	Time	Source	Destination	Delete

Add [SD test](#)

Note: Before setup recording, you may setup network storage via [NAS server](#) page



NOTE:

- ▶ Please remember to format your SD card via the camera's web console (in the Local storage . SD card management page) when using it for the first time. Please refer to page 160 for detailed information.

Recording Settings

Click **Add** to open the recording setting window. On this page, you can define the adaptive recording, recording source, recording schedule, and recording capacity. A total of 2 recording settings can be configured.

Recording name:

Enable this recording

With adaptive recording

Pre-event recording: seconds [0~9]

Post-event recording: seconds [0~10]

Priority:

Source:

1. Trigger

2. Destination

Trigger

Schedule

Sun Mon Tue Wed Thu Fri Sat

Time

Always

From to [hh:mm]

Network fail

Note: To enable recording notification please configure [Event](#) first

Close Save

- Recording name: Enter a name for the recording setting.
- Enable this recording: Select this option to enable video recording.
- With adaptive recording: Select this option will activate the frame rate control according to alarm trigger. The frame control means that when there is a triggered alarm, the frame rate will raise up to the value you've configured on the Video quality page. Please refer to page 87 for more information.

If you enable adaptive recording on a camera, only when an event is triggered on Camera A will the server record the full frame rate streaming data; otherwise, it will only request the I frame data during normal monitoring, thus effectively saves bandwidths and storage space.

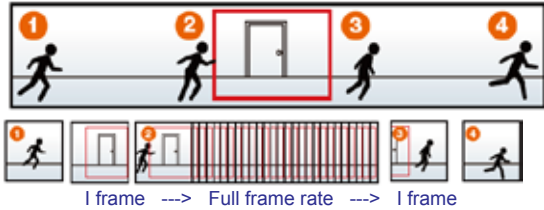

NOTE:

- ▶ To enable adaptive recording, please make sure you've set up the trigger source such as Motion Detection, DI Device, or Manual Trigger.
- ▶ When there is no alarm trigger:
 - JPEG mode: record 1 frame per second.
 - H.264 mode: record the I frame only.
- ▶ When the I frame period is >1s on Video settings page, firmware will force decrease the I frame period to 1s when adaptive recording is enabled.

The alarm trigger includes: motion detection and DI detection. Please refer to Event Settings on page 132.

■ Pre-event recording and post-event recording

The Network Camera has a buffer that temporarily holds data for a period of time. Therefore, when an event occurs, the camera can retrieve image frames taken several seconds ago. Enter a number to define the duration of recording before and after a trigger is activated.

- Priority: Select the relative importance of this recording (High, Normal, or Low). Recording with a higher priority setting will be executed first.
- Source: Select a video stream as the recording source.

NOTE:

- ▶ To enable recording notification please configure **Event settings** first . Please refer to page 132.

Please follow the steps below to set up the recording.

1. Trigger

Select a trigger source.

Trigger

Schedule

Sun Mon Tue Wed Thu Fri Sat

Time

Always

From to [hh:mm]

Network fail

- Schedule: The server will start to record files on the local storage or network storage (NAS).
- Network fail: Since network fail, the server will start to record files on the local storage (SD card).

2. Destination

You can select the SD card or network storage (NAS) for the recorded video files. If you have not configured a NAS server, see details in the following.

Priority:

Source:

1. Trigger

↓

2. Destination

Destination

Destination:

Capacity:

Entire free space

Reserved space: Mbytes

Enable cyclic recording

Recording file management

Maximum duration: minutes [1~30]

Maximum file size: MB [100~2000]

File name prefix:

Note: To enable recording notification please configure [Event](#) first

NAS server

Click **Add NAS server** to open the server setting window and follow the steps below to set up:

1. Fill in the information for your server.

For example:

1. Trigger

↓

2. Destination

Destination:

Add NAS server

Server name: 3

Server type

Network storage

Network storage location: Network storage path
(\\server name or IP address\folder name)

(For example: \\my_nas\disk\folder)

Workgroup:

User name: User name and password for your server

Password:

2
 4

2. Click **Test** to check the setting. The result will be shown in the pop-up window.

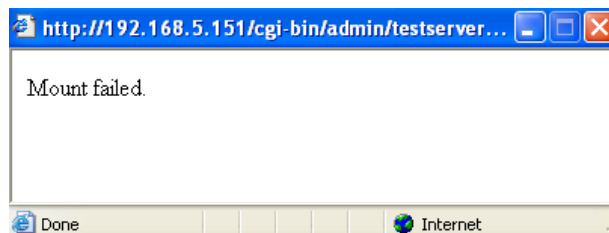
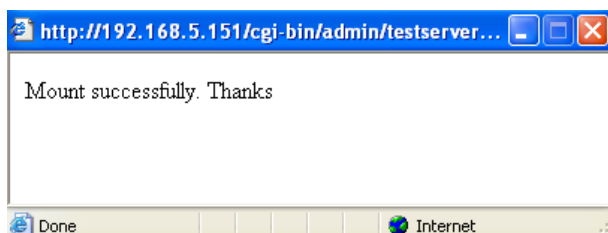

If successful, you will receive a test.txt file on the network storage server.

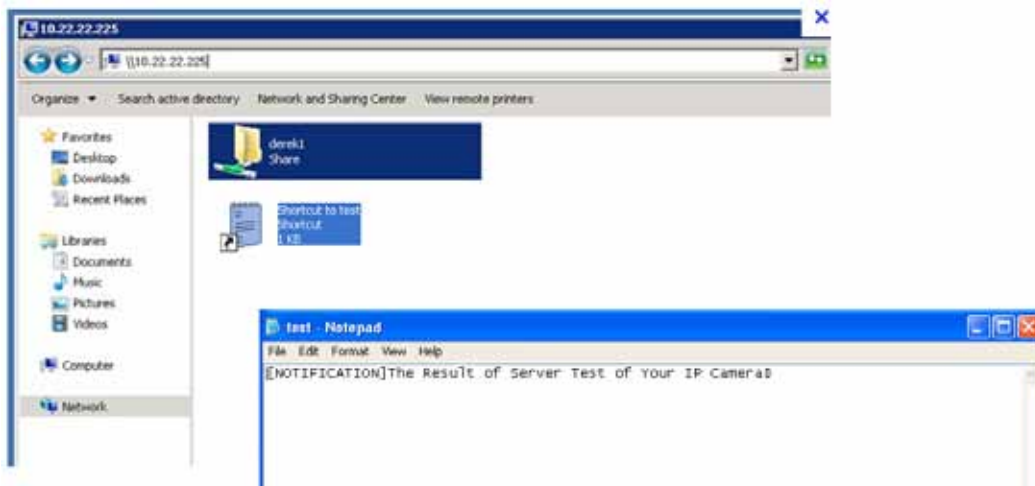

3. Enter a server name.

4. Click **Save** to complete the settings and click **Close** to exit the page.

Recording name:

Enable this recording

With adaptive recording ([Help](#))

Pre-event recording: seconds [0-9]

Post-event recording: seconds [0-10]

Priority:

Source:

1. Trigger

2. Destination

Destination

Destination:

Capacity:

Entire free space

Reserved space: Mbytes

Enable cyclic recording

Recording file management

Maximum duration: minutes [1-30]

Maximum file size: MB [100-900]

File name prefix:

Note: To enable recording notification please configure [Event](#) first

- **Capacity:** You can choose either the entire free space available or limit the reserved space. The recording size limit must be larger than the reserved amount for cyclic recording. The reserved space is a small amount of space used only for the transaction stage when the capacity is about to be used up or recycled.
- **Enable cyclic recording:** If you check this item, when the maximum capacity is reached, the oldest file will be overwritten by the latest one. The reserved amount is reserved for the transaction stage when the storage space is about to be full and new data arrives. The minimum for the Reserved space must be larger than 15 MegaBytes.
- **Recording file management:** You can manually assign the Maximum duration and the Maximum file size for each recording footage. You may need to stitch individual files together under some circumstances. You may also designate a file name prefix by filling in the responsive text field.
- **File name prefix:** Enter the text that will be appended to the front of the file name.

If you want to enable recording notification, please click [Event](#) to configure event triggering settings. Please refer to **Event > Event settings** on page 132 for more details.

When completed, select **Enable this recording**. Click **Save** to enable the setting and click **Close** to exit this page. When the system begins recording, it will send the recorded files to the network storage. The new recording name will appear in the drop-down list on the recording page as shown below.

To remove a recording setting from the list, select a recording name from the drop-down list and click **Delete**.

Recording settings												
Name	Status	Sun	Mon	Tue	Wed	Thu	Fri	Sat	Time	Source	Destination	Delete
recording	ON	V	V	V	V	V	V	V	00:00~24:00	stream1	NAS	Delete
Add		SD test										

- Click [recording \(Name\)](#): Opens the Recording Settings page to modify.
- Click [ON \(Status\)](#): The Status will become [OFF](#) and stop recording.
- Click [NAS \(Destination\)](#): Opens the file list of recordings as shown below. For more information about folder naming rules, please refer to page 139 for details.

<input type="checkbox"/>	20190210
<input type="checkbox"/>	20190211
<input type="checkbox"/>	20190212
Delete	
Delete all	

Local storage > SD card management



NOTE:

- It is recommended to turn OFF the recording activity before you remove an SD card from the camera.
- The lifespan of an SD card is limited. Regular replacement of the SD card can be necessary.
- Camera filesystem takes up several megabytes of memory space. The storage space cannot be used for recording.
- Using an SD card that already contains data recorded by another device should not be used in this camera.
- Please do not modify or change the folder names in the SD card. That may result in camera malfunctions.

This section explains how to manage the local storage on the Network Camera. Here you can view SD card status, and implement SD card control.

SD card status

This column shows the status and reserved space of your SD card. Please remember to format the SD card when using for the first time.

SD card status

SD card status: Detached ——— **no SD card**

Total size: 0 KBytes Free size: 0 KBytes

Used size: 0 KBytes Use (%): 0 %

SD card status

SD card status: Ready

File system: FAT32

Total size:	15323496 KBytes	Free size:	15087976 KBytes
Used size:	235520 KBytes	Use (%):	1.537 %

SD card format

The Linux kernel EXT4 file system format applies to SD card larger than 32GB. However, if EXT4 is applied, the computers running Windows will not be able to access the contents on the SD card unless using some 3rd-party software .

SD card format

Ext4
▼

Ext4
FAT32

SD card control

SD card control

Enable cyclic storage

Enable automatic disk cleanup

Maximum duration for keeping files: days

- **Enable cyclic storage:** Check this item if you want to enable cyclic recording. When the maximum capacity is reached, the oldest file will be overwritten by the latest one.
- **Enable automatic disk cleanup:** Check this item and enter the number of days you wish to retain a file. For example, if you enter “7 days”, the recorded files will be stored on the SD card for 7 days.

Click **Save** to enable your settings.

Local storage > Content management

This section explains how to manage the content of recorded videos on the Network Camera. Here you can search and view the records and view the searched results.

Searching and Viewing the Records

This column allows the user to set up search criteria for recorded data. If you do not select any criteria and click **Search** button, all recorded data will be listed in the **Search Results** column.

Search

Trigger type

Backup System boot Motion

Network fail Recording notify Periodically

Shock detection Tampering detection VADP

Manual triggers

Media type

Video clip Snapshot Text

Time

Search for last

From: :

to: :

- **File attributes:** Select one or more items as your search criteria.
- **Trigger time:** Manually enter the time range you want to search for contents created at a specific point in time.

Click **Search** and the recorded data corresponding to the search criteria will be listed in **Search Results** window.

Search Results

The following is an example of search results. There are four columns: Trigger time, Media type, Trigger type, and Locked. Click  to sort the search results in either direction.

Numbers of entries displayed on one page

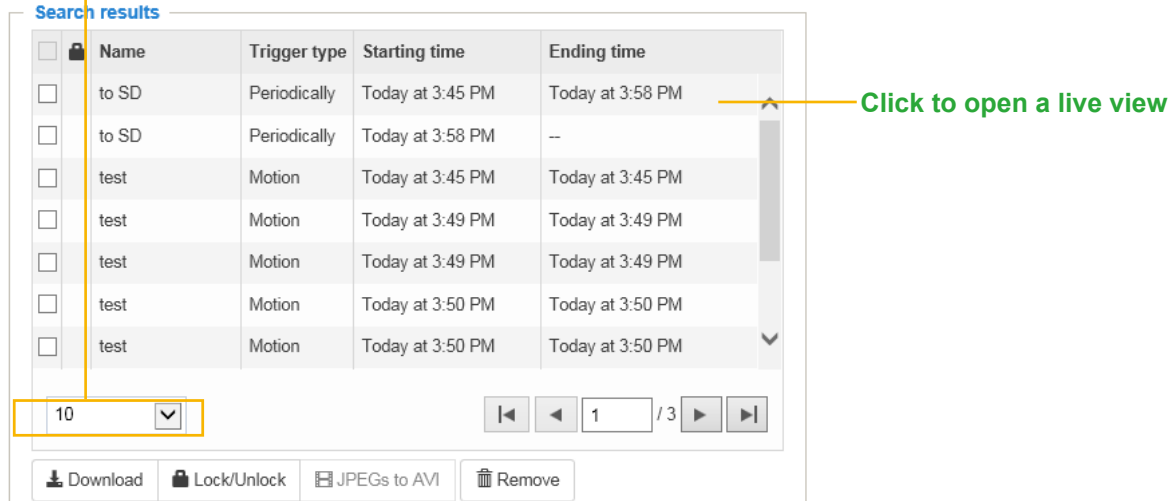

Search results

<input type="checkbox"/>	Name	Trigger type	Starting time	Ending time
<input type="checkbox"/>	to SD	Periodically	Today at 3:45 PM	Today at 3:58 PM
<input type="checkbox"/>	to SD	Periodically	Today at 3:58 PM	--
<input type="checkbox"/>	test	Motion	Today at 3:45 PM	Today at 3:45 PM
<input type="checkbox"/>	test	Motion	Today at 3:49 PM	Today at 3:49 PM
<input type="checkbox"/>	test	Motion	Today at 3:49 PM	Today at 3:49 PM
<input type="checkbox"/>	test	Motion	Today at 3:50 PM	Today at 3:50 PM
<input type="checkbox"/>	test	Motion	Today at 3:50 PM	Today at 3:50 PM

10 / 3

Download Lock/Unlock JPEGs to AVI Remove

Click to open a live view

- Play: Click on a search result which will highlight the selected item. A Play window will appear on top for immediate review of the selected file.
For example:



- Download: Click on a search result to highlight the selected item in purple as shown above. Then click the **Download** button and a file download window will pop up for you to save the file.
- JPEGs to AVI: This functions only applies to “JPEG“ format files such as snapshots. You can select several snapshots from the list, then click this button. Those snapshots will be converted into an AVI file.

- **Lock/Unlock:** Select the checkbox in front of a desired search result, then click this button. The selected items will become Locked, which will not be deleted during cyclic recording. You can click again to unlock the selections.

For example:

Search results

<input type="checkbox"/>		Name	Trigger type	Starting time	Ending time
<input type="checkbox"/>		to SD	Periodically	Today at 3:45 PM	Today at 3:58 PM
<input type="checkbox"/>		to SD	Periodically	Today at 3:58 PM	--
<input checked="" type="checkbox"/>		test	Motion	Today at 3:45 PM	Today at 3:45 PM
<input checked="" type="checkbox"/>		test	Motion	Today at 3:49 PM	Today at 3:49 PM
<input checked="" type="checkbox"/>		test	Motion	Today at 3:49 PM	Today at 3:49 PM
<input type="checkbox"/>		test	Motion	Today at 3:50 PM	Today at 3:50 PM
<input type="checkbox"/>		test	Motion	Today at 3:50 PM	Today at 3:50 PM

10
 1 / 3

Click to switch pages

- **Remove:** Select the desired search results, then click this button to delete the files.

Appendix

URL Commands for the Network Camera

1. Overview

For some customers who already have their own web site or web control application, the Network Camera/Video Server can be easily integrated through URL syntax. This section specifies the external HTTP-based application programming interface. The HTTP-based camera interface provides the functionality to request a single image, control camera functions (PTZ, output relay etc.), and get and set internal parameter values. The image and CGI-requests are handled by the built-in Web server.

2. Style Convention

In URL syntax and in descriptions of CGI parameters, text within angle brackets denotes content that is to be replaced with either a value or a string. When replacing the text string, the angle brackets should also be replaced. An example of this is the description of the name for the server, denoted with `<servername>` in the URL syntax description below, that is replaced with the string `myserver` in the URL syntax example further down in the page.

URL syntax is denoted with the word "Syntax:" written in bold face followed by a box with the referenced syntax as shown below. For example, name of the server is written as `<servername>` and is intended to be replaced with the name of the actual server. This can either be a name, e.g., "mywebcam" or "thecam.adomain.net" or the associated IP number for the server, e.g., 192.168.0.220.

Syntax:

```
http://<servername>/cgi-bin/viewer/video.jpg
```

Description of returned data is written with "Return:" in bold face followed by the returned data in a box. All data is returned in HTTP format, i.e., each line is separated with a Carriage Return and Line Feed (CRLF) printed as `\r\n`.

Return:

```
HTTP/1.0 <HTTP code> <HTTP text>\r\n
```

URL syntax examples are written with "Example:" in bold face followed by a short description and a light grey box with the example.

Example: request a single snapshot image

```
http://mywebserver/cgi-bin/viewer/video.jpg
```

3. General CGI URL Syntax and Parameters

CGI parameters are written in lower-case and as one word without any underscores or other separators. When the CGI request includes internal camera parameters, these parameters must be written exactly as they are named in the camera or video server. The CGIs are organized in functionally-related directories under the cgi-bin directory. The file extension .cgi is required.

Syntax:

```
http://<servername>/cgi-bin/<subdir>[/<subdir>...]/<cgi>.<ext>  
[?<parameter>=<value>[&<parameter>=<value>...]]
```

Example: Set digital output #1 to active

<http://mywebserver/cgi-bin/dido/setdo.cgi?do1=1>

4. Security Level

SECURITY LEVEL	SUB-DIRECTORY	DESCRIPTION
0	anonymous	Unprotected.
1 [view]	viewer	Can view, listen, and talk to camera.
4 [operator]	operator	Operator access rights can modify most of the camera's parameters except some privileges and network options.
6 [admin]	admin	Administrator access rights can fully control the camera's operations.
7	N/A	Internal APIs. Unable to be changed by any external interfaces.

A viewer account can access all APIs with security level 0 and 1. An operator account can access all APIs with security level 0, 1, or 4. An admin account can access all APIs except internal APIs.

Access management is based on the URL directory structure and is described in following paragraphs.

5. Get Server Parameter Values

Note: The access right depends on the URL directory.

Method: GET/POST

Syntax:

```
http://<servername>/cgi-bin/<anonymous>/getparam.cgi? [<parameter>]
[&<parameter>...]

http://<servername>/cgi-bin/<viewer>/getparam.cgi? [<parameter>]
[&<parameter>...]

http://<servername>/cgi-bin/<operator>/getparam.cgi? [<parameter>]
[&<parameter>...]

http://<servername>/cgi-bin/<admin>/getparam.cgi? [<parameter>]
[&<parameter>...]
```

Where the *<parameter>* should be *<group>[_<name>]* or *<group>[.<name>]*. If you do not specify any parameters, all the parameters on the server will be returned. If you specify only *<group>*, the parameters of the related group will be returned.

When querying parameter values, the current parameter values are returned.

A successful control request returns parameter pairs as follows:

Return:

```
HTTP/1.0 200 OK\r\n
Content-Type: text/html\r\n
Content-Length: <length>\r\n
\r\n
<parameter pair>
```

where *<parameter pair>* is

```
<parameter>=<value>\r\n
```

```
[<parameter pair>]
```

<length> is the actual length of content.

Example: Request IP address and its response

Request:

```
http://192.168.0.123/cgi-bin/admin/getparam.cgi?network_ipaddress
```

Response:

```
HTTP/1.0 200 OK\r\n
```

```
Content-Type: text/html\r\n
```

```
Content-Length: 33\r\n
```

```
\r\n
```

```
network.ipaddress=192.168.0.123\r\n
```

6. Set Server Parameter Values

Note: The access right depends on the URL directory.

Method: GET/POST

Syntax:

```
http://<servername>/cgi-bin/<anonymous>/setparam.cgi? <parameter>=<value>
[&<parameter>=<value>...][&return=<return page>]
```

```
http://<servername>/cgi-bin/<viewer>/setparam.cgi? <parameter>=<value>
[&<parameter>=<value>...][&return=<return page>]
```

```
http://<servername>/cgi-bin/<operator>/setparam.cgi? <parameter>=<value>
[&<parameter>=<value>...][&return=<return page>]
```

```
http://<servername>/cgi-bin/<admin>/setparam.cgi? <parameter>=<value>
[&<parameter>=<value>...][&return=<return page>]
```

PARAMETER	DESCRIPTION
<parameter>	A full path like: "videoin_c0_s0_h264_resolution", "videoin_c0_s0_h264_maxframe", etc.
<value>	The assigned <value> to the <parameter>.
<return page>	Redirect to the page <return page>after the <parameter> is assigned. The <return page>can be a full URL path or relative path according to the current path. If you omit this parameter, it will redirect to an empty page. (Note: The return page can be a general HTML file (.htm, .html). It cannot be a CGI command or have any extra parameters. This parameter must be placed at the end of the parameter list.

Return:

```
HTTP/1.0 200 OK\r\n
Content-Type: text/html\r\n
Context-Length: <length>\r\n
\r\n
<parameter pair>
```

where<parameter pair> is

```
<parameter>=<value>\r\n
```

[<parameter pair>]

Only the parameters that you set and are readable will be returned.

Example: Set the IP address of server to 192.168.0.123:

Request:

http://myserver/cgi-bin/admin/setparam.cgi?network_ipaddress=192.168.0.123

Response:

HTTP/1.0 200 OK\r\n

Content-Type: text/html\r\n

Content-Length: 33\r\n

\r\n

network.ipaddress=192.168.0.123\r\n

7. Available Parameters on the Server

Valid values:

VALID VALUES	DESCRIPTION
string[<n>]	Text strings shorter than 'n' characters. The characters “’,<, >, & are invalid.
string[n~m]	Text strings longer than 'n' characters and shorter than 'm' characters. The characters “’,<, >, & are invalid.
password[<n>]	The same as string but displays "*" instead.
<integer>	Any single integer number in 32-bits. The range is -2147483648~2147483647.
<positive integer>	Any single positive integer number in 32-bits. The range is 1~ 4294967295.
<m> ~ <n>	Any number between 'm' and 'n'.
domain name[<n>]	A string limited to a domain name shorter than 'n' characters (eg. www.ibm.com).
email address [<n>]	A string limited to an email address shorter than 'n' characters (eg. joe@www.ibm.com).
<ip address>	A string limited to an IP address (eg. 192.168.1.1).
<mac address>	A string limited to contain a MAC address without hyphens or colons.
<boolean>	A boolean value of 1 or 0 represents [Yes or No], [True or False], [Enable or Disable].
<value1>, <value2>, <value3>, ...	Enumeration. Only given values are valid.
blank	A blank string.
everything inside <>	A description
integer primary key	SQLite data type. A 32-bit signed integer. The value is assigned a unique integer by the server.
<text>	SQLite data type. The value is a text string, stored using the database encoding (UTF-8, UTF-16BE or UTF-16-LE).
<coordinate>	x, y coordinate (eg. 0,0)
<window size>	window width and height (eg. 800x600)
<W,H>	The format for coordinate in 2D. W is the pixel number of width. H is the pixel number of height. EX: (176,144)

VALID VALUES	DESCRIPTION
<WxH>	The format for resolution. W is the pixel number of width. H is the pixel number of height. Ex: 1920x1080, 2048x1536
available	The API is listed in product WebAPIs.
non-available	The API is not in product WebAPIs.
valid	The API is listed in product WebAPIs, and is functional.
non-valid	The API is listed in product WebAPIs, but is malfunction in this status.
<decimal>	Any decimal number expressed in 32-bits ranging from 1.18e-38~3.40e+38.

NOTE: The camera should not be restarted when parameters are changed.

7.1 System

Group: **system**

NAME	VALUE	SECURITY (get/set)	DESCRIPTION
hostname	string[64]	1/6	Host name of server (Network Camera, Wireless Network Camera, Video Server, Wireless Video Server).
ledoff	<boolean>	6/6	Turn on (0) or turn off (1) all led indicators.
date	<YYYY/MM/DD >, keep, auto	6/6	Current date of system. Set to 'keep' to keep date unchanged. Set to 'auto' to use NTP to synchronize date.
time	<hh:mm:ss>, keep, auto	6/6	Current time of the system. Set to 'keep' to keep time unchanged. Set to 'auto' to use NTP to synchronize time.
datetime	<MMDDhhmm YYYY.ss>	6/6	Another current time format of the system.
ntp	<domain name>, <ip address>,	6/6	NTP server. *Do not use "skip to invoke default server" for default value.

NAME	VALUE	SECURITY (get/set)	DESCRIPTION
	<blank>		
timezoneindex	-489 ~ 529	6/6	<p>Indicate timezone and area.</p> <p>-480: GMT-12:00 Eniwetok, Kwajalein</p> <p>-440: GMT-11:00 Midway Island, Samoa</p> <p>-400: GMT-10:00 Hawaii</p> <p>-360: GMT-09:00 Alaska</p> <p>-320: GMT-08:00 Las Vegas, San_Francisco, Vancouver</p> <p>-280: GMT-07:00 Mountain Time, Denver</p> <p>-281: GMT-07:00 Arizona</p> <p>-240: GMT-06:00 Central America, Central Time, Mexico City, Saskatchewan</p> <p>-200: GMT-05:00 Eastern Time, New York, Toronto</p> <p>-201: GMT-05:00 Bogota, Lima, Quito, Indiana</p> <p>-180: GMT-04:30 Caracas</p> <p>-160: GMT-04:00 Atlantic Time, Canada, La Paz, Santiago</p> <p>-140: GMT-03:30 Newfoundland</p> <p>-120: GMT-03:00 Brasilia, Buenos Aires, Georgetown, Greenland</p> <p>-80: GMT-02:00 Mid-Atlantic</p> <p>-40: GMT-01:00 Azores, Cape_Verde_IS.</p> <p>0: GMT Casablanca, Greenwich Mean Time: Dublin, Edinburgh, Lisbon, London</p> <p>40: GMT 01:00 Amsterdam, Berlin, Rome, Stockholm, Vienna, Madrid, Paris</p> <p>41: GMT 01:00 Warsaw, Budapest, Bern</p> <p>80: GMT 02:00 Athens, Helsinki, Istanbul, Riga</p> <p>81: GMT 02:00 Cairo</p> <p>82: GMT 02:00 Lebanon, Minsk</p> <p>83: GMT 02:00 Israel</p>

NAME	VALUE	SECURITY (get/set)	DESCRIPTION
			120: GMT 03:00 Baghdad, Kuwait, Riyadh, Moscow, St. Petersburg, Nairobi 121: GMT 03:00 Iraq 140: GMT 03:30 Tehran 160: GMT 04:00 Abu Dhabi, Muscat, Baku, Tbilisi, Yerevan 180: GMT 04:30 Kabul 200: GMT 05:00 Ekaterinburg, Islamabad, Karachi, Tashkent 220: GMT 05:30 Calcutta, Chennai, Mumbai, New Delhi 230: GMT 05:45 Kathmandu 240: GMT 06:00 Almaty, Novosibirsk, Astana, Dhaka, Sri Jayawardenepura 260: GMT 06:30 Rangoon 280: GMT 07:00 Bangkok, Hanoi, Jakarta, Krasnoyarsk 320: GMT 08:00 Beijing, Chongging, Hong Kong, Kuala Lumpur, Singapore, Taipei 360: GMT 09:00 Osaka, Sapporo, Tokyo, Seoul, Yakutsk 380: GMT 09:30 Adelaide, Darwin 400: GMT 10:00 Brisbane, Canberra, Melbourne, Sydney, Guam, Vladivostok 440: GMT 11:00 Magadan, Solomon Is., New Caledonia 480: GMT 12:00 Aucklan, Wellington, Fiji, Kamchatka, Marshall Is. 520: GMT 13:00 Nuku'Alofa
daylight_enable	<boolean>	6/6	Enable automatic daylight saving time in time zone.
daylight_dstactualmode	<positive integer>	6/7	Check if current time is under daylight saving time. (Used internally)

NAME	VALUE	SECURITY (get/set)	DESCRIPTION
daylight_auto_begintime	string[19]	6/7	Display the current daylight saving start time.
daylight_auto_endtime	string[19]	6/7	Display the current daylight saving end time.
daylight_timezones	string	6/6	List time zone index which support daylight saving time.
updateinterval	0, 3600, 86400, 604800, 2592000	6/6	0 to Disable automatic time adjustment, otherwise, it indicates the seconds between NTP automatic update intervals.
restore	0, <positive integer>	7/6	Restore the system parameters to default values after <value> seconds.
reset	0, <positive integer>	7/6	Restart the server after <value> seconds if <value> is non-negative.
restoreexceptnet	0, <positive integer>	7/6	Restore the system parameters to default values except (ipaddress, subnet, router, dns1, dns2, pppoe). This command can cooperate with other "restoreexceptXYZ" commands. When cooperating with others, the system parameters will be restored to the default value except for a union of the combined results.
restoreexceptdst	0, <positive integer>	7/6	Restore the system parameters to default values except all daylight saving time settings. This command can cooperate with other "restoreexceptXYZ" commands. When cooperating with others, the system parameters will be restored to default values except for a union of combined results.
restoreexceptlang	0,	7/6	Restore the system parameters to default

NAME	VALUE	SECURITY (get/set)	DESCRIPTION
	<positive integer>		values except the custom language file the user has uploaded. This command can cooperate with other "restoreexceptXYZ" commands. When cooperating with others, the system parameters will be restored to the default value except for a union of the combined results.
restoreexceptvadvp	0, <positive integer>	7/6	Restore the system parameters to default values except the vadvp parameters and VADP modules that stored in the system. This command can cooperate with other "restoreexceptXYZ" commands. When cooperating with others, the system parameters will be restored to the default value except for a union of the combined results.
restoreexceptfocusvalue	0, <positive integer>	7/6	Restore the system parameters to default values except zoom and focus value. This command can cooperate with other "restoreexceptXYZ" commands. When cooperating with others, the system parameters will be restored to the default value except for a union of the combined results. * Only available when "capability_image_c<0~(n-1)>_remotefocus" != 0.
restoreexceptlen	0, <positive integer>	7/6	Restore the system parameters to default values except lens profile. This command can cooperate with other "restoreexceptXYZ" commands. When cooperating with others, the system parameters will be restored to the default value except for a union of the combined results.

NAME	VALUE	SECURITY (get/set)	DESCRIPTION
			* Only available when "capability_image_c<0~(n-1)>_lensconfiguration_support" != 0.

7.1.1 System.Info

Subgroup of **system: info** (The fields in this group are unchangeable.)

NAME	VALUE	SECURITY (get/set)	DESCRIPTION
modelname	string[40]	0/7	Internal model name of the server
extendedmodelname	string[40]	0/7	ODM specific model name of server (eg. DCS-5610). If it is not an ODM model, this field will be equal to "modelname"
serialnumber	<mac address>	1/7	12 characters MAC address (without hyphens).
firmwareversion	string[40]	0/7	Firmware version, including model, company, and version number in the format:<MODEL-BRAND-VERSION>
language_count	<positive integer>	0/7	Number of webpage languages available on the server.
language_i<0~(count-1)>	string[16] language_i0 : English language_i1 : Deutsch language_i2 : Español language_i3 : Français language_i4 : Italiano language_i5 : 日本語 language_i6 : Português	0/7	Available language lists.

NAME	VALUE	SECURITY (get/set)	DESCRIPTION
	language_i7 : 简体中文 language_i8 : 繁體中文		
customlanguage_maxcount	0,<positive integer>	0/6	Maximum number of custom languages supported on the server.
customlanguage_count	0,<positive integer>	0/6	Number of custom languages which have been uploaded to the server.
customlanguage_i<0~(maxcount-1)>	string	0/6	Custom language name.

7.2 Status

Group: **status**

NAME	VALUE	SECURITY (get/set)	DESCRIPTION
di_i<0~(capability_ndi-1)> <product dependent>	<boolean>	1/7	0 => Inactive, normal 1 => Active, triggered (capability_ndi > 0)
do_i<0~(capability_ndo-1)> <product dependent>	<boolean>	1/7	0 => Inactive, normal 1 => Active, triggered (capability_ndo > 0)
onlinenum_rtsp	0,<positive integer>	6/7	Current number of RTSP connections.
onlinenum_httppush	0,<positive integer>	6/7	Current number of HTTP push server connections.
onlinenum_sip	0,<positive integer>	6/7	Current number of SIP connections.
eth_i0	<string>	1/7	Get network information from mii-tool.
vi_i<0~(capability_nvi-1)> <product dependent>	<boolean>	1/7	Virtual input 0 => Inactive 1 => Active (capability_nvi > 0)

7.2.1 Status per Channel

Group: **status_c<0~(n-1)>** for n channel products

n denotes the value of "capability_nvideoin"

NAME	VALUE	SECURITY (get/set)	DESCRIPTION
signal_detect	<boolean>	1/7	Indicates whether the video source is connected or not. * Only available when capability_videoin_type is 0 or 1.
signal_type	ntsc,pal	1/7	The actual modulation type. * Only available when capability_videoin_type is 0 or 1.

7.3 Digital Input Behavior Define

Group: **di_i<0~(n-1)>** for n is the value of "capability_ndi" (**capability_capability_ndi > 0**)

NAME	VALUE	SECURITY (get/set)	DESCRIPTION
normalstate	high, low	1/1	Indicates open circuit or closed circuit (inactive status)

7.4 Digital Output Behavior Define

Group: **do_i<0~(n-1)>** for n is the value of "capability_ndo" (**capability_ndo > 0**)

NAME	VALUE	SECURITY (get/set)	DESCRIPTION
normalstate	open, grounded	1/1	Indicate open circuit or closed circuit (inactive status)

7.5 Security

1. Group: security

NAME	VALUE	SECURITY (get/set)	DESCRIPTION
privilege_do	view, operator, admin	1/6	Indicate which privileges and above can control digital output (capability_ndo > 0)
privilege_camctrl	view, operator, admin	1/6	Indicate which privileges and above can control PTZ (capability_ptzenabled > 0 or capability_eptz > 0)
user_i0_name	string[64]	6/7	User name of root
user_i<1~20>_name	string[64]	6/7	User name
user_i0_pass	password[64]	7/6	Root password
user_i<1~20>_pass	password[64]	7/6	User password
user_i0_privilege	view, operator, admin	6/7	Root privilege
user_i<1~20>_privilege	view, operator, admin	6/6	User privilege

7.6 Network

Group: network

NAME	VALUE	SECURITY (get/set)	DESCRIPTION
preprocess	<positive integer>	6/6	An 32-bit integer, each bit can be set separately as follows: Bit 0 => HTTP service; Bit 1=> HTTPS service; Bit 2=> FTP service; Bit 3 => Two way audio and RTSP Streaming service; To stop service before changing its port

NAME	VALUE	SECURITY (get/set)	DESCRIPTION
			<p>settings. It's recommended to set this parameter when change a service port to the port occupied by another service currently. Otherwise, the service may fail.</p> <p>Stopped service will auto-start after changing port settings.</p> <p>Ex: Change HTTP port from 80 to 5556, and change RTP port for video from 5556 to 20480.</p> <p>Then, set preprocess=9 to stop both service first.</p> <p>"/cgi-bin/admin/setparam.cgi?network_preprocess=9&network_http_port=5556&network_rtp_videoport=20480"</p>
type	lan, pppoe	6/6	Network connection type.
resetip	<boolean>	6/6	<p>1 => Get ipaddress, subnet, router, dns1, dns2 from DHCP server at next reboot.</p> <p>0 => Use preset ipaddress, subnet, router, dns1, and dns2.</p>
ipaddress	<ip address>	6/6	IP address of server.
subnet	<ip address>	6/6	Subnet mask.
router	<ip address>	6/6	Default gateway.
dns1	<ip address>	6/6	Primary DNS server.
dns2	<ip address>	6/6	Secondary DNS server.
wins1	<ip address>	6/6	Primary WINS server.
wins2	<ip address>	6/6	Secondary WINS server.

7.6.1 802.1x

Subgroup of **network: ieee8021x** (*capability_protocol_ieee8021x > 0*)

NAME	VALUE	SECURITY (get/set)	DESCRIPTION
enable	<boolean>	6/6	Enable/disable IEEE 802.1x
eapmethod	eap-peap, eap-tls	6/6	Selected EAP method
identity_peap	string[64]	6/6	PEAP identity
identity_tls	string[64]	6/6	TLS identity
password	string[200]	7/6	Password for TLS
privatekeypassword	string[200]	7/6	Password for PEAP
ca_exist	<boolean>	6/6	CA installed flag
ca_time	0,<positive integer>	6/7	CA installed time. Represented in EPOCH
ca_size	0,<positive integer>	6/7	CA file size (in bytes)
certificate_exist	<boolean>	6/6	Certificate installed flag (for TLS)
certificate_time	0,<positive integer>	6/7	Certificate installed time. Represented in EPOCH
certificate_size	0,<positive integer>	6/7	Certificate file size (in bytes)
privatekey_exist	<boolean>	6/6	Private key installed flag (for TLS)
privatekey_time	0,<positive integer>	6/7	Private key installed time. Represented in EPOCH
privatekey_size	0,<positive integer>	6/7	Private key file size (in bytes)

7.6.2 QOS

Subgroup of **network: qos_cos** (*capability_protocol_qos_cos > 0*)

NAME	VALUE	SECURITY (get/set)	DESCRIPTION
enable	<boolean>	6/6	Enable/disable CoS (IEEE 802.1p)
vlanid	1~4095	6/6	VLAN ID
video	0~7	6/6	Video channel for CoS
audio	0~7	6/6	Audio channel for CoS
<product dependent>			(<i>capability_naudioin > 0</i>)

NAME	VALUE	SECURITY (get/set)	DESCRIPTION
eventalarm	0~7	6/6	Event/alarm channel for CoS
management	0~7	6/6	Management channel for CoS
eventtunnel	0~7	6/6	Event/Control channel for CoS

Subgroup of **network: qos_dscp** (*capability_protocol_qos_dscp > 0*)

NAME	VALUE	SECURITY (get/set)	DESCRIPTION
enable	<boolean>	6/6	Enable/disable DSCP
video	0~63	6/6	Video channel for DSCP
audio	0~63	6/6	Audio channel for DSCP (<i>capability_naudioin > 0</i>)
eventalarm	0~63	6/6	Event/alarm channel for DSCP
management	0~63	6/6	Management channel for DSCP
eventtunnel	0~63	6/6	Event/Control channel for DSCP

7.6.3 IPV6

Subgroup of **network: ipv6** (*capability_protocol_ipv6 > 0*)

NAME	VALUE	SECURITY (get/set)	DESCRIPTION
enable	<boolean>	6/6	Enable IPv6.
addonipaddress	<ip address>	6/6	IPv6 IP address.
addonprefixlen	0~128	6/6	IPv6 prefix length.
addonrouter	<ip address>	6/6	IPv6 router address.
addondns	<ip address>	6/6	IPv6 DNS address.
allowoptional	<boolean>	6/6	Allow manually setup of IP address setting.

7.6.4 FTP

Subgroup of **network: ftp**

NAME	VALUE	SECURITY (get/set)	DESCRIPTION
port	21, 1025~65535	6/6	Local ftp server port.
enable	<boolean>	6/6	Enable ftp.

7.6.5 HTTP

Subgroup of **network: http**

NAME	VALUE	SECURITY (get/set)	DESCRIPTION
port	80, 1025 ~ 65535	1/6	HTTP port.
alternateport	1025~65535	6/6	Alternate HTTP port.
authmode	basic, digest	1/6	HTTP authentication mode.
s<0~(capability_nmediastream-1)>_accessname <product dependent> <Not recommended to use this>	string[32]	1/6	Http server push access name for stream N, N= 1~ capability_nmediastream. (capability_protocol_push_mjpeg =1 and capability_nmediastream > 0) The value are shown as video1s1.mjpg = c0_s0_accessname, (channel1stream1) video1s2.mjpg = c0_s1_accessname, (channel1stream2) video1s3.mjpg = c0_s2_accessname, (channel1stream3) video1s4.mjpg = c0_s3_accessname, (channel1stream4) etc. * We replace this parameter with "network_http_c<0~(capability_nvideoin-1)>_s<0~(capability_nmediastream-1)>_accessname " when the version number (httpversion) is equal or greater than 0311c.
anonymousviewing	<boolean>	1/6	Enable anonymous streaming viewing.

7.6.6 HTTP per Channel

Subgroup of **network**: **http_c<0~(n-1)>** for n channel products

n denotes the value of "capability_nvideoin"

NAME	VALUE	SECURITY (get/set)	DESCRIPTION
s<0~(capability_nmedia stream-1)>_accessname <product dependent>	string[32]	1/6	<p>Http server push access name for channel N and stream M, N= 1~ capability_nvideoin, M= 1~ capability_nmediastream. (capability_protocol_spush_mjpeg =1 and capability_nmediastream > 0)</p> <p>The value are shown as video1s1.mjpg = c0_s0_accessname, (channel1stream1) video1s2.mjpg = c0_s1_accessname, (channel1stream2) video2s1.mjpg = c1_s0_accessname, (channel2stream1) video2s2.mjpg = c1_s1_accessname, (channel2stream2) etc.</p> <p>* We support this parameter when the version number (httpversion) is equal or greater than 0311c.</p>

7.6.7 HTTS Port

Subgroup of **network**: **https** (capability_protocol_https > 0)

NAME	VALUE	SECURITY (get/set)	DESCRIPTION
port	443, 1025 ~ 65535	1/6	HTTPS port.

7.6.8 RTSP

Subgroup of **network: rtsp** (**capability_protocol_rtsp > 0**)

NAME	VALUE	SECURITY (get/set)	DESCRIPTION
port	554, 1025 ~ 65535	1/6	RTSP port. (capability_protocol_rtsp=1)
anonymousviewing	<boolean>	1/6	Enable anonymous streaming viewing.
authmode	disable, basic, digest	1/6	RTSP authentication mode. (capability_protocol_rtsp=1)
s<0~(capability_nmediastream*capability_nvideoin)-1>_accessname <product dependent>	string[32]	1/6	RTSP access name for channel/stream N, N= 1~ capability_nmediastream. (capability_protocol_spush_mjpeg =1 and capability_nmediastream > 0) The value are shown as live1s1.sdp = c0_s0_accessname, (channel1stream1) live1s2.sdp = c0_s1_accessname, (channel1stream2) live1s3.sdp = c0_s2_accessname, (channel1stream3) live1s4.sdp = c0_s3_accessname, (channel1stream4) etc.

7.6.9 RTSP Multicast

Subgroup of `network_rtsp_s<0~(n-1)>_multicast`

n denotes the value of "capability_nmediastream * capability_nvideoin"

NAME	VALUE	SECURITY (get/set)	DESCRIPTION
alwaysmulticast	<boolean>	4/4	Enable always multicast.
ipaddress	<ip address>	4/4	Multicast video IP address. * We replace "network_rtsp_s<0~(n-1)>_multicast_ipaddress" with " network_rtsp_s<0~(n-1)>_multicast_videoipadd ress". * Reserved for compatibility, and suggest don't use this since [httpversion] > 0304a
videoipaddress	<ip address>	4/4	Multicast video IP address. * We support this parameter when the version number (httpversion) is equal or greater than 0304a.
audioipaddress <product dependent>	<ip address>	4/4	Multicast audio IP address. * We support this parameter when the version number (httpversion) is equal or greater than 0304a. * Only available when capability_naudioin > 0
metadataipaddres s	<ip address>	4/4	Multicast metadata IP address. * We support this parameter when the version number (httpversion) is equal or greater than 0304a.
videoport	1025 ~ 65535	4/4	Multicast video port.
audioport <product dependent>	1025 ~ 65535	4/4	Multicast audio port. * Only available when capability_naudioin > 0
metadataport	1026~6553 4	4/4	Multicast metadata port.
ttl	1 ~ 255	4/4	Multicasttime to live value.

7.6.10 SIP Port

Subgroup of **network: sip** (*capability_protocol_sip > 0*)

NAME	VALUE	SECURITY (get/set)	DESCRIPTION
port	1025 ~ 65535	1/6	SIP port.

7.6.11 RTP Port

Subgroup of **network: rtp**

NAME	VALUE	SECURITY (get/set)	DESCRIPTION
videoport	1025 ~ 65535	6/6	Video channel port for RTP.
audioport	1025 ~ 65535	6/6	Audio channel port for RTP.
metadataport	1025 ~ 65535	6/6	Metadata channel port for RTP.

7.6.12 PPPoE

Subgroup of **network: pppoe** (*capability_protocol_pppoe > 0*)

NAME	VALUE	SECURITY (get/set)	DESCRIPTION
user	string[128]	6/6	PPPoE account user name.
pass	password[64]	7/6	PPPoE account password.

7.7 IP Filter

Group: **ipfilter**

NAME	VALUE	SECURITY (get/set)	DESCRIPTION
enable	<boolean>	6/6	Enable access list filtering.
admin_enable	<boolean>	6/6	Enable administrator IP address.
admin_ip	string[43]	6/6	Administrator IP address.
maxconnection	1~ "capability_protoc ol_maxconnection"	6/6	Maximum number of (s).

NAME	VALUE	SECURITY (get/set)	DESCRIPTION
type	0, 1	6/6	Ipfilter policy : 0 => allow 1 => deny
ipv4list_i<0~9>	Single address: <ip address> Network address: <ip address / network mask> Range address:<start ip address - end ip address>	6/6	IPv4 address list.
ipv6list_i<0~9>	string[43]	6/6	IPv6 address list.

7.8 Video Input

Group: **videoin**

NAME	VALUE	SECURITY (get/set)	DESCRIPTION
cmosfreq	50, 60	4/4	CMOS frequency. * Only available when capability_videoin_type is 2.
whitebalance <product dependent>	auto, panorama, manual, rbgain, widerange, outdoor, indoor, sodiumauto, etc (Available values are listed in "capability_image_c<0~(n-1)>_wbmo	4/4	Modes of white balance. " auto ": Auto white balance " panorama ": indicates that camera would try to balance the white balance effect of every sensor. " rbgain ": Use rgain and bgain to set white balance manually. " manual ": 2 cases: a. if "rbgain" is not supported, this means keep current white balance status. b. if "rbgain" is supported, "rgain" and "bgain" are updated to the current values which is got from

NAME	VALUE	SECURITY (get/set)	DESCRIPTION
	de")		white balance module. Then, act as rbgain mode "widerange" : Auto Tracing White balance (2000K to 10000K). "outdoor" : auto white balance mode specifically for outdoor. "indoor" : auto white balance mode specifically for indoor. "sodiumauto" : sodium vapor lamps. * Only available when "capability_image_c<0~(n-1)>_wbmode" != "-"
exposurelevel	0~12	4/4	Exposure level "0,12": This range takes the concept from DC's exposure tuning options. The definition is: 0: EV -2.0 1: EV -1.7 2: EV -1.3 3: EV -1.0 4: EV -0.7 5: EV -0.3 6: EV 0 7: EV +0.3 8: EV +0.7 9: EV +1.0 10: EV +1.3 11: EV +1.7 12: EV +2.0 * Only available when "capability_image_c<0~(n-1)>_exposure_mode" != 0
irismode	fixed, indoor, outdoor <product independent>	4/4	Control DC-Iris mode. "outdoor" : Auto-setting DC-Iris to get best quality, but easy to meet rolling or flicker effect in indoor

NAME	VALUE	SECURITY (get/set)	DESCRIPTION
			environment. "indoor" : Avoid rolling and flicker effect first. "fixed" : Open the iris to maximum. * Only available when "capability_image_c<0~(n-1)>_iristype"=dciris
enableblc <Not support anymore>	<boolean>	4/4	Enable backlight compensation. * Not support this parameter anymore when the version number (httpversion) is equal or greater than 0301a. * It's recommended to use "exposurewin_c<0~(n-1)>_mode" to switch on/off BLC.
color	0, 1	4/4	0 => monochrome 1 => color * Only available when "capability_videoin_c<0~(n-1)>_color_support" is 1.
flip	<boolean>	4/4	Flip the image.
mirror	<boolean>	4/4	Mirror the image.
rotate	0,90,180,270	1/4	The rotation angle of image. Support only in Rotation mode. * Only available when "capability_videoin_c<0~(n-1)>_rotation"=1
ptzstatus <Not support anymore>	0,<positive integer>	1/7	A 32-bit integer, each bit can be set separately as follows: Bit 0 => Support camera control function; 0(not support), 1(support) Bit 1 => Built-in or external camera; 0 (external), 1(built-in) Bit 2 => Support pan operation; 0(not support), 1(support)

NAME	VALUE	SECURITY (get/set)	DESCRIPTION
			Bit 3 => Support tilt operation; 0(not support), 1(support) Bit 4 => Support zoom operation; 0(not support), 1(support) Bit 5 => Support focus operation; 0(not support), 1(support)(SD/PZ/IZ series only)
text	string[64]	1/4	Enclose caption.
imprinttimestamp	<boolean>	4/4	Overlay time stamp on video.
minexposure <product dependent>	<1~32000>, <5~32000>, <1~8000>, <5~8000>, etc. * Available value is listed in "capability_image_c<0~(n-1)>_exposure_minrange"	4/4	Minimum exposure time 1~32000 => 1s ~ 1/32000s 5~32000 => 1/5s ~ 1/32000s 1~8000 => 1s ~ 1/8000s 5~8000 => 1/5s ~ 1/8000s etc. * Only available when "capability_image_c<0~(n-1)>_exposure_minrange" != "-" * Only valid when "piris_mode"=manual or "irismode"=fixed * Only available when "capability_image_c<0~(n-1)>_exposure_rangetype" is "twovalues".
maxexposure <product dependent>	<1~32000>, <5~32000>, <1~8000>, <5~8000>, etc. * Available value is listed in "capability_image_c<0~(n-1)>_exposure_maxrange"	4/4	Maximum exposure time 1~32000 => 1s ~ 1/32000s 5~32000 => 1/5s ~ 1/32000s 1~8000 => 1s ~ 1/8000s 5~8000 => 1/5s ~ 1/8000s etc. * This parameter may also restrict image frame rate from sensor due to sensor generates a frame per exposure time. Ex: If this is set to 1/5s ~ 1/8000s and camera takes 1/5s on

NAME	VALUE	SECURITY (get/set)	DESCRIPTION
			<p>the night, then sensor only outputs 5 frame/s.</p> <p>* Only available when "capability_image_c<0~(n-1)>_exposure_maxrange" != "-"</p> <p>* Only valid when "piris_mode"=manual or "irismode"=fixed</p> <p>* Only available when "capability_image_c<0~(n-1)>_exposure_rangetype" is "twovalues".</p>
enablepreview	<boolean>	1/4	<p>Usage for UI of exposure settings. Preview settings of video profile.</p> <p>* Only available when "capability_image_c<0~(n-1)>_exposure_mode" !=0</p>

7.8.1 Video Input Setting per Channel

Group: **videoin_c<0~(n-1)>** for n channel products, and m is stream number

n denotes the value of "capability_nvideoin", m denotes the value of "capability_nmediastream"

NAME	VALUE	SECURITY(get/set)	DESCRIPTION
cmosfreq	50, 60	4/4	CMOS frequency. * Only available when "capability_videoin_type" is 2
mode	0 ~ "capability_videoin_c<0~(n-1)>_nmode"-1	4/4	Indicate the video mode on use.
whitebalance <product dependent>	auto, panorama, manual, rbgain, widerange, outdoor, indoor, sodiumauto, etc (Available values are listed in "capability_image_c<0~(n-1)>_wbmode")	4/4	Modes of white balance. " auto ": Auto white balance " panorama ": indicates that camera would try to balance the white balance effect of every sensor. " rbgain ": Use rgain and bgain to set white balance manually. " manual ": 2 cases: a. if "rbgain" is not supported, this means keep current white balance status. b. if "rbgain" is supported, "rgain" and "bgain" are updated to the current values which is got from white balance module. Then, act as rbgain mode " widerange ": Auto Tracing White balance (2000K to 10000K). " outdoor ": auto white balance mode specifically for outdoor. " indoor ": auto white balance mode specifically for indoor. " sodiumauto ": sodium vapor lamps. * Only available when "capability_image_c<0~(n-1)>_wbmo

NAME	VALUE	SECURITY(get/set)	DESCRIPTION
			de" !="-"
rgain	0~100	4/4	Manual set rgain value of gain control setting. 0: Weak <-> 100: Strong * Only available when "rbgain" is listed in "capability_image_c<0~(n-1)>_wbmode". * Only valid when "videoin_c<0~(n-1)>_whitebalance" != auto * Normalized range.
bgain	0~100	4/4	Manual set bgain value of gain control setting. 0: Weak <-> 100: Strong * Only available when "rbgain" is listed in "capability_image_c<0~(n-1)>_wbmode". * Only valid when "videoin_c<0~(n-1)>_whitebalance" != auto * Normalized range.
exposurelevel	0~12	4/4	Exposure level "0,12": This range takes the concept from DC's exposure tuning options. The definition is: 0: EV -2.0 1: EV -1.7 2: EV -1.3 3: EV -1.0 4: EV -0.7 5: EV -0.3 6: EV 0 7: EV +0.3 8: EV +0.7

NAME	VALUE	SECURITY(get/set)	DESCRIPTION
			9: EV +1.0 10: EV +1.3 11: EV +1.7 12: EV +2.0 * Only available when "capability_image_c<0~(n-1)>_exposure_mode" !=0
exposuremode <product dependent>	auto, shutterpriority, irispriority, qualitypriority, manual, etc (Available options are list in "capability_image_c<0~(n-1)>_exposure_modetype")	4/4	Select exposure mode. "auto" : Automatically adjust the Iris, Gain and Shutter Speed to fit the exposure level. "shutterpriority" : Manually adjust with variable Shutter Speed, and keep adjusting Iris, Gain automatically. "irispriority" : Manually adjust with variable Iris, and keep adjusting Gain and Shutter speed automatically. "qualitypriority" : Automatically adjust the Iris, Gain and Shutter Speed by VIVOTEK quality algorithm. "manual" : Manually adjust with variable Shutter, Iris and Gain. * We support this parameter when the version number (httpversion) is equal or greater than 0302a. * Only available when "capability_image_c<0~(n-1)>_exposure_mode" !=0
irismode	fixed, indoor, outdoor <product dependent>	4/4	Control DC-Iris mode. "outdoor" : Auto-setting DC-Iris to get best quality, but easy to meet rolling or flicker effect in indoor environment. "indoor" : Avoid rolling and flicker effect first. "fixed" : Open the iris to maximum.

NAME	VALUE	SECURITY(get/set)	DESCRIPTION
			* Only available when "capability_image_c<0~(n-1)>_iristype "=dciris
piris_mode <product dependent>	manual, indoor, outdoor,-	1/4	Control P-Iris mode. " outdoor ": Auto-setting P-Iris to get best quality, but easy to meet rolling or flicker effect in indoor environment. " indoor ": Avoid rolling and flicker effect first. " manual ": Manual set P-Iris by "piris_position". "-": not support. (only available when "capability_image_c<0~(n-1)>_sensor type" is "smartsensor") * Only available when "capability_image_c<0~(n-1)>_iristype "=piris
piris_position <product dependent>	1~100	1/4	Manual set P-Iris. 1: Open <-> 100: Close * Only valid when "piris_mode"=manual or "capability_image_c<0~(n-1)>_sensor type" is "smartsensor" * Only available when "capability_image_c<0~(n-1)>_iristype "=piris
enablebhc <Not support anymore>	<boolean>	4/4	Enable backlight compensation * Not support this parameter anymore when the version number (httpversion) is equal or greater than 0301a. * It's recommended to use "exposurewin_c<0~(n-1)>_mode" to switch on/off BLC.
maxgain	0~100	4/4	Maximum gain value.

NAME	VALUE	SECURITY(get/set)	DESCRIPTION
			0: Low <-> 100: High * Only available when "capability_image_c<0~(n-1)>_agc_m axgain" != "-" * Only valid when "piris_mode"=manual or "irismode"=fixed * Normalized range. * Only available when "capability_image_c<0~(n-1)>_exposu re_rangetype" is "twovalues".
mingain	0~100	4/4	Minimum gain value. 0: Low <-> 100: High * Only available when "capability_image_c<0~(n-1)>_agc_mi ngain" != "-" * Only valid when "piris_mode"=manual or "irismode"=fixed * Normalized range. * Only available when "capability_image_c<0~(n-1)>_exposu re_rangetype" is "twovalues".
gainvalue	0~100	4/4	Gain value. 0: Low <-> 100: High * Only available when "capability_image_c<0~(n-1)>_agc_m axgain" != "-" and "capability_image_c<0~(n-1)>_exposu re_rangetype" is "onevalue". * Normalized range. * We support this parameter when the version number (httpversion) is equal or greater than 0302a.
color	0, 1	4/4	0 => monochrome 1 => color

NAME	VALUE	SECURITY(get/set)	DESCRIPTION
			* Only available when " capability_videoin_c<0~(n-1)>_color_ support" is 1.
flip	<boolean>	4/4	Flip the image.
mirror	<boolean>	4/4	Mirror the image.
rotate	0,90,180,270	1/4	The rotation angle of image. Support only in Rotation mode (capability_videoin_c<0~(n-1)>_rotation=1)
ptzstatus <Not support anymore>	0,<positive integer>	1/7	A 32-bit integer, each bit can be set separately as follows: Bit 0 => Support camera control function; 0(not support), 1(support) Bit 1 => Built-in or external camera; 0 (external), 1(built-in) Bit 2 => Support pan operation; 0(not support), 1(support) Bit 3 => Support tilt operation; 0(not support), 1(support) Bit 4 => Support zoom operation; 0(not support), 1(support) Bit 5 => Support focus operation; 0(not support), 1(support)(SD/PZ/IZ series only)
text	string[64]	1/4	Enclose caption.
imprnttimesta mp	<boolean>	4/4	Overlay time stamp on video.
textonvideo_p osition	top, bottom	4/4	Text on video string position
textonvideo_si ze	20~40	4/4	Text on video font size
textonvideo_fo ntpath	/usr/share/font/Default.ttf , /mnt/flash2/upload.ttf	4/4	Choose camera default font file (/usr/share/font/Default.ttf) or user uploaded font file(/mnt/flash2/upload.ttf).
textonvideo_u	Depends on the font file	1/7	Show the uploaded font file name.

NAME	VALUE	SECURITY(get/set)	DESCRIPTION
ploadfilename	name uploaded by user		
minexposure <product dependent>	<p><1~32000>, <5~32000>, <1~8000>, <5~8000>, etc.</p> <p>* Available value is listed in "capability_image_c<0~(n-1)>_exposure_minrange"</p>	4/4	<p>Minimum exposure time 1~32000 => 1s ~ 1/32000s 5~32000 => 1/5s ~ 1/32000s 1~8000 => 1s ~ 1/8000s 5~8000 => 1/5s ~ 1/8000s etc.</p> <p>* Only available when "capability_image_c<0~(n-1)>_exposure_minrange" != "-"</p> <p>* Only valid when "piris_mode"=manual or "irismode"=fixed</p> <p>* Only available when "capability_image_c<0~(n-1)>_exposure_rangetype" is "twovalues".</p>
maxexposure <product dependent>	<p><1~32000>, <5~32000>, <1~8000>, <5~8000>, etc.</p> <p>* Available value is listed in "capability_image_c<0~(n-1)>_exposure_maxrange"</p>	4/4	<p>Maximum exposure time 1~32000 => 1s ~ 1/32000s 5~32000 => 1/5s ~ 1/32000s 1~8000 => 1s ~ 1/8000s 5~8000 => 1/5s ~ 1/8000s etc.</p> <p>* This parameter may also restrict image frame rate from sensor due to sensor generates a frame per exposure time. Ex: If this is set to 1/5s ~ 1/8000s and camera takes 1/5s on the night, then sensor only outputs 5 frame/s.</p> <p>* Only available when "capability_image_c<0~(n-1)>_exposure_maxrange" != "-"</p> <p>* Only valid when "piris_mode"=manual or "irismode"=fixed</p> <p>* Only available when</p>

NAME	VALUE	SECURITY(get/set)	DESCRIPTION
			"capability_image_c<0~(n-1)>_exposure_rangetype" is "twovalues".
shuttervalue <product dependent>	<1~32000>, <5~32000>, <1~8000>, <5~8000>, etc. * Available value is listed in "capability_image_c<0~(n-1)>_exposure_maxrange"	4/4	Exposure time 1~32000 => 1s ~ 1/32000s 5~32000 => 1/5s ~ 1/32000s 1~8000 => 1s ~ 1/8000s 5~8000 => 1/5s ~ 1/8000s etc. * This parameter may also restrict image frame rate from sensor due to sensor generates a frame per exposure time. Ex: If this is set to 1/5s ~ 1/8000s and camera takes 1/5s on the night, then sensor only outputs 5 frame/s. * Only available when "capability_image_c<0~(n-1)>_exposure_maxrange" != "-" and "capability_image_c<0~(n-1)>_exposure_rangetype" is "onevalue". * We support this parameter when the version number (httpversion) is equal or greater than 0302a.
enablepreview	<boolean>	1/4	Usage for UI of exposure settings. Preview settings of video profile. * Only available when "capability_image_c<0~(n-1)>_exposure_mode" != 0
meteringmode	auto, blc, hlc * Available value is listed in "capability_image_c<0~(n-1)>_exposure_meteringmode"	4/4	" auto ": The algorithm chooses the best metering strategy. " blc ": This metering method increases the weight of dark area. " hlc ": The metering method can detect strong light and make affected area clear.

NAME	VALUE	SECURITY(get/set)	DESCRIPTION
			* We support this parameter when the version number (httpversion) is equal or greater than 0311a.
crop_position	<coordinate> (x,y)	1/7	Crop left-top corner coordinate.
crop_size	<window size> (WxH)	1/7	Crop width and height. (width must be 16x or 32x and height must be 8x)
zoomratiodisplay	<boolean>	1/4	Indicates multiple of zoom in is "on-screen display" or not. * We support this parameter when the version number (httpversion) is equal or greater than 0302a.
bracketing_level	1~100	4/4	<ul style="list-style-type: none"> ● The total available lists (capability_image_c<0~(n-1)>_exposure_bracketing_range) will be normalized to 1~100 scale. ● For example, the total available list is 7. (2x,3x,4x,5x,6x,7x,8x) ● 1 ~ 14 that correspond with 2x. ● 15 ~ 30 that correspond with 3x. *Only available when "capability_image_c<0~(n-1)>_exposure_bracketing_mode"=1. * We support this parameter when the version number (httpversion) is equal or greater than 0310a.
s<0~(m-1)>_enableeptz	<boolean>	4/4	Indicate whether stream supports eptz or not
s<0~(m-1)>_codec_type	Listed at "capability_videoin_codec" " Possible values are: mjpeg, h264,h265 <product dependent>	1/4	Codec type for this stream
s<0~(m-1)>_resolution	Available options are list in	1/4	Video resolution in pixels.

NAME	VALUE	SECURITY(get/set)	DESCRIPTION
solution	"capability_videoin_c<0~(n-1)>_resolution". Besides, available options is referred to "capability_videoin_c<0~(n-1)>_maxresolution" and "capability_videoin_c<0~(n-1)>_minresolution"		
s<0~(m-1)>_smartfps_enable	<boolean>	4/4	Enable "Smart fps" function. * Only available when "capability_videoin_c<0~(n-1)>_smartfps_support" is 1. * We support this parameter when the version number (httpversion) is equal or greater than 0309a.
s<0~(m-1)>_h264_dintra period_enable	<boolean>	4/4	Enable "Dynamic intra frame period". * Only available when "capability_videoin_c<0~(n-1)>_dintra period_support" is 1. * We support this parameter when the version number (httpversion) is equal or greater than 0301c.
s<0~(m-1)>_h264_intraperiod	250, 500, 1000, 2000, 3000, 4000	4/4	The time interval between two I-frames (Intra coded picture). The unit is millisecond (ms).
s<0~(m-1)>_h264_ratecontrol mode	cbr, vbr	4/4	cbr : Constant bit rate mode. vbr : Fixed quality mode, all frames are encoded in the same quality.
s<0~(m-1)>_h264_quant	1~5, 99, 100	4/4	Set the pre-defined quality level: 1: Medium 2: Standard 3: Good 4: Detailed 5: Excellent 100: Use the quality level in

NAME	VALUE	SECURITY(get/set)	DESCRIPTION
			"qpercent" 99: Use the quality level in "qvalue" * Only valid when "h264_ratecontrolmode"= vbr.
s<0~(m-1)>_h264_qvalue	0~51	4/4	Manual video quality level input. The Q value which is used by encoded library directly. * Only valid when "h264_ratecontrolmode"= vbr and s<0~(m-1)>_h264_quant = 99.
s<0~(m-1)>_h264_qpercent	1~100	4/4	Select customized quality in a normalized full range. 1: Worst quality 100: Best quality * Only valid when "h264_ratecontrolmode"= vbr and "quant"= 100.
s<0~(m-1)>_h264_maxvbrbitrate	20000~"capability_videoin_c<0~(n-1)>_h264_maxbitrate"	4/4	The maximum allowed bit rate in fixed quality mode. When the bit rate exceeds this value, frames will be dropped to restrict the bit rate. * Only valid when "h264_ratecontrolmode"= vbr
s<0~(m-1)>_h264_cbr_quant	1~5, 100	4/4	Set the pre-defined quality level: 1: Medium 2: Standard 3: Good 4: Detailed 5: Excellent 100: Use the quality level in "cbr_qpercent" * Only available when "h264_ratecontrolmode"= cbr. * Only available when "capability_smartstream_version" >=

NAME	VALUE	SECURITY(get/set)	DESCRIPTION
			"2.0"
s<0~(m-1)>_h264_cbr_quality	1~100	4/4	Select customized quality in a normalized full range. 1: Worst quality 100: Best quality * Only valid when "h264_ratecontrolmode"= cbr and "quant"= 100. * Only available when "capability_smartstream_version">= "2.0"
s<0~(m-1)>_h264_bitrate	20000~"capability_videoin_c<0~(n-1)>_h264_maxbitrate"	4/4	The target bit rate in constant bit rate mode. * Only valid when "h264_ratecontrolmode"= cbr
s<0~(m-1)>_h264_prioritypolicy	framerate,imagequality	4/4	Set prioritypolicy * Only valid when "h264_ratecontrolmode"= cbr
s<0~(m-1)>_h264_maxframe	1~"capability_videoin_c<0~(n-1)>_h264_maxframerate"	1/4	The maximum frame rates of a H264 stream at different resolutions("capability_videoin_c<0~(n-1)>_resolution") are recorded in "capability_videoin_c<0~(n-1)>_h264_maxframerate"
s<0~(m-1)>_h264_profile	0~2	1/4	Indicate H264 profiles 0: baseline 1: main profile 2: high profile
s<0~(m-1)>_h264_smartq_enable	<boolean>	4/4	Enable "Smart Q" function. * Only available when "capability_videoin_c<0~(n-1)>_smartq_support" is 1. * We support this parameter when the version number (httpversion) is equal or greater than 0309a.
s<0~(m-1)>_h264_dynamic_intra_frame_period	<boolean>	4/4	Enable "Dynamic intra frame period".

NAME	VALUE	SECURITY(get/set)	DESCRIPTION
65_dintraperiod_enable			<p>* Only available when "capability_videoin_c<0~(n-1)>_dintra period_support" is 1 and h265 is listed in "capability_videoin_codec".</p> <p>* We support this parameter when the version number (httpversion) is equal or greater than 0301c.</p>
s<0~(m-1)>_h265_intraperiod	250, 500, 1000, 2000, 3000, 4000	4/4	<p>The time interval between two I-frames (Intra coded picture). The unit is millisecond (ms).</p> <p>* Only available when h265 is listed in "capability_videoin_codec".</p>
s<0~(m-1)>_h265_ratecontrolmode	cbr, vbr	4/4	<p>cbr: Constant bit rate mode.</p> <p>vbr: Fixed quality mode, all frames are encoded in the same quality.</p> <p>* Only available when h265 is listed in "capability_videoin_codec".</p>
s<0~(m-1)>_h265_quant	1~5, 99, 100	4/4	<p>Set the pre-defined quality level:</p> <p>1: Medium</p> <p>2: Standard</p> <p>3: Good</p> <p>4: Detailed</p> <p>5: Excellent</p> <p>100: Use the quality level in "qpercent"</p> <p>99: Use the quality level in "qvalue"</p> <p>* Only available when h265 is listed in "capability_videoin_codec" and "h265_ratecontrolmode"= vbr.</p>
s<0~(m-1)>_h265_qvalue	0~51	4/4	<p>Manual video quality level input. The Q value which is used by encoded library directly.</p> <p>* Only available when h265 is listed in "capability_videoin_codec".</p> <p>* Only valid when "h265_ratecontrolmode"= vbr and</p>

NAME	VALUE	SECURITY(get/set)	DESCRIPTION
			s<0~(m-1)>_h265_quant = 99.
s<0~(m-1)>_h265_qpercent	1~100	4/4	Select customized quality in a normalized full range. 1: Worst quality 100: Best quality * Only available when h265 is listed in "capability_videoin_codec". * Only valid when "h265_ratecontrolmode"= vbr and "quant"= 100.
s<0~(m-1)>_h265_maxvbrbitrate	20000~"capability_videoin_c<0~(n-1)>_h265_maxbitrate"	4/4	The maximum allowed bit rate in fixed quality mode. When the bit rate exceeds this value, frames will be dropped to restrict the bit rate. * Only available when h265 is listed in "capability_videoin_codec". * Only valid when "h265_ratecontrolmode"= vbr
s<0~(m-1)>_h265_cbr_quant	1~5, 100	4/4	Set the pre-defined quality level: 1: Medium 2: Standard 3: Good 4: Detailed 5: Excellent 100: Use the quality level in "cbr_qpercent" * Only available when h265 is listed in "capability_videoin_codec" and "h265_ratecontrolmode"= cbr. * Only available when "capability_smartstream_version" >= "2.0"
s<0~(m-1)>_h265_cbr_qpercent	1~100	4/4	Select customized quality in a normalized full range. 1: Worst quality

NAME	VALUE	SECURITY(get/set)	DESCRIPTION
			100: Best quality * Only available when h265 is listed in "capability_videoin_codec". * Only valid when "h265_ratecontrolmode"= cbr and "quant"= 100. * Only available when "capability_smartstream_version" >= "2.0"
s<0~(m-1)>_h265_bitrate	20000~"capability_videoin_c<0~(n-1)>_h265_maxbitrate"	4/4	The target bit rate in constant bit rate mode. * Only available when h265 is listed in "capability_videoin_codec". * Only valid when "h265_ratecontrolmode"= cbr
s<0~(m-1)>_h265_prioritypolicy	framerate,imagequality	4/4	Set prioritypolicy * Only available when h265 is listed in "capability_videoin_codec". * Only valid when "h265_ratecontrolmode"= cbr
s<0~(m-1)>_h265_maxframe	1~"capability_videoin_c<0~(n-1)>_h265_maxframe"	1/4	The maximum frame rates of a H265 stream at different resolutions("capability_videoin_c<0~(n-1)>_resolution") are recorded in "capability_videoin_c<0~(n-1)>_h265_maxframe"
s<0~(m-1)>_h265_profile	Available values are listed in "capability_videoin_c<0~(n-1)>_h265_profile"	1/4	Indicate H265 profiles * Only available when h265 is listed in "capability_videoin_codec".
s<0~(m-1)>_h265_smartq_enable	<boolean>	4/4	Enable "Smart Q" function. * Only available when h265 is listed in "capability_videoin_codec". * Only available when

NAME	VALUE	SECURITY(get/set)	DESCRIPTION
			"capability_videoin_c<0~(n-1)>_smart_q_support" is 1. * We support this parameter when the version number (httpversion) is equal or greater than 0309a.
s<0~(m-1)>_mjpeg_ratecontrolmode	cbr, vbr	4/4	cbr : Constant bit rate mode. vbr : Fixed quality mode, all frames are encoded in the same quality.
s<0~(m-1)>_mjpeg_quant	1~5, 99, 100	4/4	* Only valid when "mjpeg_ratecontrolmode"= vbr. Set the pre-defined quality level: 1: Medium 2: Standard 3: Good 4: Detailed 5: Excellent 100: Use the quality level in "qpercent" 99: Use the quality level in "qvalue"
s<0~(m-1)>_mjpeg_qvalue	10~200 (Only valid when "capability_api_httpversion" format is XXXXX_1 or XXXXX_3 or XXXXX_4 ex: 0301a_1 or 0301a_3 or 0301a_4) or 1~99 (Only valid when "capability_api_httpversion" format is XXXXX_2, ex: 0301a_2) <product dependent>	4/4	Manual video quality level input. The Q value which is used by encoded library directly. * Only valid when "mjpeg_ratecontrolmode"= vbr and s<0~(m-1)>_mjpeg_quant = 99
s<0~(m-1)>_mjpeg_qpercent	1~100	4/4	Select customized quality in a normalized full range. 1: Worst quality

NAME	VALUE	SECURITY(get/set)	DESCRIPTION
			100: Best quality * Only valid when "mjpeg_ratecontrolmode"= vbr and s<0~(m-1)>_mjpeg_quant = 100.
s<0~(m-1)>_mjpeg_maxvbrbit rate	20000~"capability_videoin_c<0~(n-1)>_mjpeg_maxbitrate"	4/4	The maximum allowed bit rate in fixed quality mode. When the bit rate exceeds this value, frames will be dropped to restrict the bit rate. * Only valid when "mjpeg_ratecontrolmode"= vbr
s<0~(m-1)>_mjpeg_cbr_quant	1~5, 100	4/4	Set the pre-defined quality level: 1: Medium 2: Standard 3: Good 4: Detailed 5: Excellent 100: Use the quality level in "cbr_qpercent" * Only valid when "mjpeg_ratecontrolmode"= cbr. * Only available when "capability_smartstream_version" >= "2.0"
s<0~(m-1)>_mjpeg_cbr_qpercent	1~100	4/4	Select customized quality in a normalized full range. 1: Worst quality 100: Best quality * Only valid when "mjpeg_ratecontrolmode"= cbr and "quant"= 100. * Only available when "capability_smartstream_version" >= "2.0"
s<0~(m-1)>_mjpeg_bitrate	20000~"capability_videoin_c<0~(n-1)>_mjpeg_maxbitrate"	4/4	The target bit rate in constant bit rate mode.

NAME	VALUE	SECURITY(get/set)	DESCRIPTION
	trate"		* Only valid when "mjpeg_ratecontrolmode"= cbr
s<0~(m-1)>_mjpeg_prioritypolicy	framerate,imagequality	4/4	Set prioritypolicy * Only valid when "mjpeg_ratecontrolmode"= cbr
s<0~(m-1)>_mjpeg_maxframe	1~"capability_videoin_c<0~(n-1)>_mjpeg_maxframerate"	1/4	The maximum frame rates of a mjpeg stream at different resolutions("capability_videoin_c<0~(n-1)>_resolution") are recorded in "capability_videoin_c<0~(n-1)>_mjpeg_maxframerate"
s<0~(m-1)>_ratiocorrect	<boolean>	1/4	Change resolution to fit 4:3 ratio. For PAL: D1/4CIF(720/704x576) -> (768x576) CIF(352x288)->(384x288) For NTSC: D1/4CIF(720/704x480) -> (640x480) CIF(352x240)->(320x240) * Only available when capability_videoin_type is 0 or 1.
wdrpro_mode <product dependent>	<boolean>	4/4	Enable WDR pro * Only available when "capability_image_c<0~(n-1)>_wdrpro_mode" > 0
wdrpro_strength <product dependent>	1~100	4/4	The strength of WDR Pro. The bigger value means the stronger strength of WDR Pro. * Only available when "capability_image_c<0~(n-1)>_wdrpro_strength" is 1
wdrc_mode <product dependent>	<boolean>	4/4	Enable WDR enhanced. * Only available when "capability_image_c<0~(n-1)>_wdrc_mode" is 1
wdrc_strength <product dependent>	1~100	4/4	The strength of WDR enhanced. The bigger value means the stronger

NAME	VALUE	SECURITY(get/set)	DESCRIPTION
dependent >			strength of WDR enhanced. * Only available when "capability_image_c<0~(n-1)>_wdrc_ mode" is 1
aespeed_mod e <product dependent>	<boolean>	4/4	Turning AE converge speed on or off. 0: off 1: on * Only available when "capability_image_c<0~(n-1)>_aespee d" is 1
aespeed_spee dlevel <product dependent>	1~100	4/4	The speed level of AE converge speed. 1~20: level 1 21~40: level 2 41~60: level 3 61~80: level 4 81~100: level 5 Level 1~4(low ~ high) The higher speed level meas shorter AE converged time during AE executing. * Only available when "capability_image_c<0~(n-1)>_aespee d" is 1
aespeed_sensi tivity <product dependent>	1~100	4/4	The sensitivity of AE converge speed. 1~20: level 1 21~40: level 2 41~60: level 3 61~80: level 4 81~100: level 5 Level 1~4(low ~ high) The higher sensitivity level meas that it is easy to be trigger while scene changed. * Only available when "capability_image_c<0~(n-1)>_aespee d" is 1 and

NAME	VALUE	SECURITY(get/set)	DESCRIPTION
			"capability_image_c<0~(n-1)>_aespeedsupportsensitivity" is 1.
flickerless <product dependent>	<boolean>	4/4	Turn on(1) or turn off(0) the flickerless mode * Only available when "capability_image_c<0~(n-1)>_flickerless" is 1.
mounttype	ceiling, wall, floor	1/6	Hardware installation. * Only available when "capability_videoin_c<0~(n-1)>_mounttype" != "-".
enablewatermark <product dependent>	0, 1	1/6	0: Not to add watermarks on images 1: Add watermarks on images * Only available when "capability_fisheye" > 0
s<0~(m-2)>_fisheyedewarpmode <product dependent>	'10, 1P, 2P, 1R, 4R' for ceiling/floor mount '10, 1P, 1R, 4R' for wall mount <product dependent>	1/4	Local dewarp mode. "10" is original mode (disable). Supported dewarp mode is different by mount type. (videoin_c<0~(n-1)>_mounttype) Supported mode list could be extracted from (capability_videoin_c<0~(n-1)>_localdewarp_typeceilingmount) and (capability_videoin_c<0~(n-1)>_localdewarp_typewallmount) * Only available when "capability_fisheylowdewarp_c<0~(capability_nvideoin)-1>" > 0

Group: videoin_c<0~(n-1)>_s<0~(m-1)>_h264_smartstream2 (capability_smartstream_support=1 and capability_smartstream_version>=2.0)

Group: videoin_c<0~(n-1)>_s<0~(m-1)>_h265_smartstream2 (capability_smartstream_support=1, capability_smartstream_version>=2.0 and h265 is listed in "capability_videoin_codec")

n denotes the value of "capability_nvideoin", m denotes the value of " capability_nmediastream"

NAME	VALUE	SECURITY (get/set)	DESCRIPTION
enable	<boolean>	4/4	Enable or Disable smart codec function
mode	autotracking,manual,hybrid	4/4	Set Smart stream mode "autotracking" : only available when "capability_smartstream_mode_autotracking" is 1. "manual" : only available when "capability_smartstream_mode_manual" is 1. "hybrid" : only available when "capability_smartstream_mode_hybrid" is 1.
qualitypriority	-5,-4,-3,-2,-1,1,2,3,4,5	4/4	The differential value of Q between the regions of interest (ROI) and the areas of non-interest (non-ROI) of the display image. If the value is a positive number, the video quality of ROI is better than the non-ROI areas. The level is from 1 to 5. Level 5 is the maximum level of the quality difference between the ROI and non-ROI areas. If the value is a negative number, the video quality of non-ROI areas is better than the ROI. The level is from -1 to -5. Level -5 is the maximum level of the quality difference between the ROI and non-ROI areas.

Group: `videoin_c<0~(n-1)>_s<0~(m-1)>_h264_smartstream2_win_i<0~(k-1)>`

(`capability_smartstream_support=1`, `capability_smartstream_version>=2.0` and `capability_smartstream_mode_manual = 1`)

Group: `videoin_c<0~(n-1)>_s<0~(m-1)>_h265_smartstream2_win_i<0~(k-1)>`

(`capability_smartstream_support=1`, `capability_smartstream_version>=2.0` and `h265` is listed in "`capability_videoin_codec`" and `capability_smartstream_mode_manual = 1`)

`n` denotes the value of "`capability_nvideoin`", `m` denotes the value of "`capability_nmediastream`", `k`

denotes the value of "capability_smartstream_nwindow_manual".

NAME	VALUE	SECURITY (get/set)	DESCRIPTION
enable	<boolean>	4/4	Enable or disable the window.
home	0~320,0~240	4/4	Left-top corner coordinate of the window.
size	0~320x0~240	4/4	Width and height of the window

7.8.1.1 Alternative Video Input Profiles per Channel

In addition to the primary setting of video input, there can be alternative profile video input setting for each channel which might be for different scene of light (daytime or nighttime).

Group: **videoin_c<0~(n-1)>_profile_i<0~(m-1)>** for n channel products and m profile

n denotes the value of "capability_nvideoin" and m denotes the value of

"capability_nvideoinprofile" (**capability_nvideoinprofile > 0**)

NAME	VALUE	SECURITY (get/set)	DESCRIPTION
enable	<boolean>	4/4	Enable/disable this profile setting
policy	night, schedule	4/4	The mode which the profile is applied to. * Not support "policy=day" anymore when the version number (httpversion) is equal or greater than 0301a.
begintime	hh:mm	4/4	Begin time of schedule mode.
endtime	hh:mm	4/4	End time of schedule mode.
minexposure <product dependent>	<1~32000>, <5~32000>, <1~8000>, <5~8000>, etc. * Available value is listed in "capability_image_c<0~(n-1)>_exposure_minrange"	4/4	Minimum exposure time 1~32000 => 1s ~ 1/32000s 5~32000 => 1/5s ~ 1/32000s 1~8000 => 1s ~ 1/8000s 5~8000 => 1/5s ~ 1/8000s etc. * Only available when "capability_image_c<0~(n-1)>_exposure_minrange" != "-" * Only valid when "piris_mode"=manual or "irismode"=fixed

NAME	VALUE	SECURITY (get/set)	DESCRIPTION
			* Only available when "capability_image_c<0~(n-1)>_exposure_rangetype" is "twovalues".
maxexposure <product dependent>	<1~32000>, <5~32000>, <1~8000>, <5~8000>, etc. * Available value is listed in "capability_image_c<0~(n-1)>_exposure_maxrange"	4/4	Maximum exposure time 1~32000 => 1s ~ 1/32000s 5~32000 => 1/5s ~ 1/32000s 1~8000 => 1s ~ 1/8000s 5~8000 => 1/5s ~ 1/8000s etc. * This parameter may also restrict image frame rate from sensor due to sensor generates a frame per exposure time. Ex: If this is set to 1/5s ~ 1/8000s and camera takes 1/5s on the night, then sensor only outputs 5 frame/s. * Only available when "capability_image_c<0~(n-1)>_exposure_maxrange" != "-" * Only valid when "piris_mode"=manual or "irismode"=fixed * Only available when "capability_image_c<0~(n-1)>_exposure_rangetype" is "twovalues".
shuttervalue <product dependent>	<1~32000>, <5~32000>, <1~8000>, <5~8000>, etc. * Available value is listed in "capability_image_c<0~(n-1)>_exposure_maxrange"	4/4	Exposure time 1~32000 => 1s ~ 1/32000s 5~32000 => 1/5s ~ 1/32000s 1~8000 => 1s ~ 1/8000s 5~8000 => 1/5s ~ 1/8000s etc. * This parameter may also restrict image frame rate from sensor due to sensor generates a frame per exposure time. Ex: If this is set to 1/5s ~ 1/8000s and camera takes 1/5s on

NAME	VALUE	SECURITY (get/set)	DESCRIPTION
			<p>the night, then sensor only outputs 5 frame/s.</p> <p>* Only available when "capability_image_c<0~(n-1)>_exposure_maxrange" != "-" and "capability_image_c<0~(n-1)>_exposure_rangetype" is "onevalue".</p> <p>* We support this parameter when the version number (httpversion) is equal or greater than 0302a.</p>
enableblc <Not support anymore>	<boolean>	4/4	<p>Enable backlight compensation.</p> <p>* Not support this parameter anymore when the version number (httpversion) is equal or greater than 0301a.</p> <p>* It's recommended to use "exposurewin_c<n>_mode" to switch on/off BLC.</p>
exposurelevel	0~12	4/4	<p>Exposure level</p> <p>"0,12": This range takes the concept from DC's exposure tuning options. The definition is:</p> <p>0: EV -2.0 1: EV -1.7 2: EV -1.3 3: EV -1.0 4: EV -0.7 5: EV -0.3 6: EV 0 7: EV +0.3 8: EV +0.7 9: EV +1.0 10: EV +1.3 11: EV +1.7 12: EV +2.0</p> <p>*Only available when</p>

NAME	VALUE	SECURITY (get/set)	DESCRIPTION
			"capability_image_c0_exposure_mod e" != 0
exposuremode <product dependent>	auto, shutterpriority, irispriority, qualitypriority, manual, etc (Available options are list in in "capability_image_c<0~(n-1)>_exposure_modetype")	4/4	Select exposure mode. "auto" : Automatically adjust the Iris, Gain and Shutter Speed to fit the exposure level. "shutterpriority" : Manually adjust with variable Shutter Speed, and keep adjusting Iris, Gain automatically. "irispriority" : Manually adjust with variable Iris, and keep adjusting Gain and Shutter speed automatically. "qualitypriority" : Automatically adjust the Iris, Gain and Shutter Speed by VIVOTEK quality algorithm. "manual" : Manually adjust with variable Shutter, Iris and Gain. * We support this parameter when the version number (httpversion) is equal or greater than 0302a. *Only available when "capability_image_c0_exposure_mod e" != 0
whitebalance <product dependent>	auto, panorama, manual, rbgain, widerange, outdoor, indoor, sodiumauto, etc (Available values are listed in in "capability_image_c<0~(n-	4/4	Modes of white balance. "auto" : Auto white balance "panorama" : indicates that camera would try to balance the white balance effect of every sensor. "rbgain" : Use rgain and bgain to set white balance manually. "manual" : 2 cases: a. if "rbgain" is not supported, this means keep current white balance status. b. if "rbgain" is supported, "rgain" and "bgain" are updated to the

NAME	VALUE	SECURITY (get/set)	DESCRIPTION
	1)>_wbmode")		<p>current values which is got from white balance module. Then, act as rbgain mode</p> <p>"widerange": Auto Tracing White balance (2000K to 10000K).</p> <p>"outdoor": auto white balance mode specifically for outdoor.</p> <p>"indoor": auto white balance mode specifically for indoor.</p> <p>"sodiumauto": sodium vapor lamps.</p> <p>* Only available when "capability_image_c<0~(n-1)>_wbmode" != "-"</p>
rgain	0~100	4/4	<p>Manual set rgain value of gain control setting.</p> <p>0: Weak <-> 100: Strong</p> <p>* Only available when "rbgain" is listed in "capability_image_c<0~(n-1)>_wbmode".</p> <p>* Only valid when "videoin_c<0~(n-1)>_whitebalance" != auto</p> <p>* Normalized range.</p>
bgain	0~100	4/4	<p>Manual set bgain value of gain control setting.</p> <p>0: Weak <-> 100: Strong</p> <p>* Only available when "rbgain" is listed in "capability_image_c<0~(n-1)>_wbmode".</p> <p>* Only valid when "videoin_c<0~(n-1)>_whitebalance" != auto</p> <p>* Normalized range.</p>
maxgain	0~100	4/4	Maximum gain value.

NAME	VALUE	SECURITY (get/set)	DESCRIPTION
			<p>0: Low <-> 100: High</p> <ul style="list-style-type: none"> * Only available when "capability_image_c<0~(n-1)>_agc_maxgain" != "-" * Only valid when "piris_mode"=manual or "irismode"=fixed * Normalized range. * Only available when "capability_image_c<0~(n-1)>_exposure_rangetype" is "twovalues".
mingain	0~100	4/4	<p>Minimum gain value.</p> <p>0: Low <-> 100: High</p> <ul style="list-style-type: none"> * Only available when "capability_image_c<0~(n-1)>_agc_mingain" != "-" * Only valid when "piris_mode"=manual or "irismode"=fixed * Normalized range. * Only available when "capability_image_c<0~(n-1)>_exposure_rangetype" is "twovalues".
gainvalue	0~100	4/4	<p>Gain value.</p> <p>0: Low <-> 100: High</p> <ul style="list-style-type: none"> * Only available when "capability_image_c<0~(n-1)>_agc_maxgain" != "-" and "capability_image_c<0~(n-1)>_exposure_rangetype" is "onevalue". * Normalized range. * We support this parameter when the version number (httpversion) is equal or greater than 0302a.
meteringmode	auto, blc,	4/4	<p>"auto": The algorithm chooses the best metering strategy.</p>

NAME	VALUE	SECURITY (get/set)	DESCRIPTION
	hlc * Available value is listed in "capability_image_c<0~(n-1)>_exposure_meteringmode"		" blc ": This metering method increases the weight of dark area. " hlc ": The metering method can detect strong light and make affected area clear. * We support this parameter when the version number (httpversion) is equal or greater than 0311a.
piris_mode <product dependent>	manual, indoor, outdoor,-	1/4	Control P-Iris mode. " outdoor ": Auto-setting P-Iris to get best quality, but easy to meet rolling or flicker effect in indoor environment. " indoor ": Avoid rolling and flicker effect first. " manual ": Manual set P-Iris by "piris_position". "-": not support (only available when "capability_image_c<0~(n-1)>_sensor type" is "smartsensor") * Only available when "capability_image_c<0~(n-1)>_iristype"="piris
piris_position <product dependent>	1~100	1/4	Manual set P-Iris. 1: Open <-> 100: Close * Only valid when "piris_mode"=manual or "capability_image_c<0~(n-1)>_sensor type" is "smartsensor" * Only available when "capability_image_c<0~(n-1)>_iristype"="piris
irismode	fixed, indoor, outdoor <product dependent>	4/4	Control DC-Iris mode. " outdoor ": Auto-setting DC-Iris to get best quality, but easy to meet rolling or flicker effect in indoor

NAME	VALUE	SECURITY (get/set)	DESCRIPTION
			environment. "indoor" : Avoid rolling and flicker effect first. "fixed" : Open the iris to maximum. * Only available when "capability_image_c<0~(n-1)>_iristype"=dciris
wdrpro_mode <product dependent>	<boolean>	4/4	Enable WDR pro * Only available when "capability_image_c<0~(n-1)>_wdrpro_mode" > 0
wdrpro_strength <product dependent>	1~100	4/4	The strength of WDR Pro. The bigger value means the stronger strength of WDR Pro. * Only available when "capability_image_c<0~(n-1)>_wdrpro_strength" is 1
wdrc_mode <product dependent>	<boolean>	4/4	Enable WDR enhanced. * Only available when "capability_image_c<0~(n-1)>_wdrc_mode" is 1
wdrc_strength <product dependent>	1~100	4/4	The strength of WDR enhanced. The bigger value means the stronger strength of WDR enhanced. * Only available when "capability_image_c<0~(n-1)>_wdrc_mode" is 1
aespeed_mode <product dependent>	<boolean>	4/4	Turning AE converge speed on or off. 0: off 1: on * Only available when "capability_image_c<0~(n-1)>_aespeed" is 1
aespeed_speedlevel <product dependent>	1~100	4/4	The speed level of AE converge speed. 1~20: level 1 21~40: level 2

NAME	VALUE	SECURITY (get/set)	DESCRIPTION
dependent >			41~60: level 3 61~80: level 4 81~100: level 5 Level 1~4(low ~ high) The higher speed level meas shorter AE converged time during AE executing. * Only available when "capability_image_c<0~(n-1)>_aespeed" is 1
aespeed_sensitivity <product dependent>	1~100	4/4	The sensitivity of AE converge speed. 1~20: level 1 21~40: level 2 41~60: level 3 61~80: level 4 81~100: level 5 Level 1~4(low ~ high) The higher sensitivity level meas that it is easy to be trigger while scene changed. * Only available when "capability_image_c<0~(n-1)>_aespeed" is 1 and "capability_image_c<0~(n-1)>_aespeedsupportsensitivity" is 1.
flickerless <product dependent>	<boolean>	4/4	Turn on(1) or turn off(0) the flickerless mode * Only available when "capability_image_c<0~(n-1)>_flickerless" is 1

7.9 Time Shift Settings

Group: **timeshift** for n channel products and m stream

n denotes the value of "capability_nvideoin", m denotes the value of "capability_nmediastream"
(**capability_timeshift > 0**)

NAME	VALUE	SECURITY (get/set)	DESCRIPTION
enable	<boolean>	4/4	Enable time shift streaming.
c<0~(n-1)>_s< 0~(m-1)>_allo w	<boolean>	4/4	Enable time shift streaming for specific stream.

7.10 IR Cut Control

Group: **ircutcontrol** (**capability_daynight_c<0~(n-1)>_support > 0**)

n denotes the value of "capability_nvideoin"

NAME	VALUE	SECURITY (get/set)	DESCRIPTION
mode	auto, day, night, di, schedule...etc * Available values are listed in "capability_daynight_c<0~(n-1)>_mode" <product dependent>	6/6	Set IR cut control mode
sir <product dependent>	<boolean>	6/6	Enable/disable Smart IR * Only available when "capability_daynight_c<0~"capability_nvideoin"-1>_smartir" is 1
daymodebegintime	00:00~23:59	6/6	Day mode begin time
daymodeendtime	00:00~23:59	6/6	Day mod end time

NAME	VALUE	SECURITY (get/set)	DESCRIPTION
disableirled	<boolean>	6/6	Enable/disable built-in IR led * Only available when "capability_daynight_illuminators_builtin_support > 0" and irled is listed in "capability_daynight_illuminators_builtin_type"
enableextled	<boolean>	1/6	Enable/disable external IR led * Only available when "capability_daynight_illuminators_external_support > 0".
enablewled	<boolean>	6/6	Enable/disable built-in White led * Only available when "capability_daynight_illuminators_builtin_support > 0" and whiteled is listed in "capability_daynight_illuminators_builtin_type"
bwmode	<boolean>	6/6	Switch to B/W in night mode if enabled. * Only available when "capability_daynight_c<0~(n-1)>_blackwhitemode" is 1.
sensitivity	low,normal,high,1~100	6/6	Sensitivity of day/night control. There are two value format: "low,normal,high" : if capability_daynight_c<0~(n-1)>_ircutsensitivity_type=options "1~100" : if capability_daynight_c<0~(n-1)>_ircutsensitivity_type=normalize * Only available when "capability_daynight_c<0~(n-1)>

NAME	VALUE	SECURITY (get/set)	DESCRIPTION
			_ircutsensitivity_type" is not "-".
spectrum_mode	visible, ir, irenhanced, blueenhanced <product dependent>	6/6	Set spectrum method . * Only available when "capability_daynight_illuminators_ spectrum_support > 0".

7.11 Image Setting per Channel

Group: **image_c<0~(n-1)>** for n channel products and m profile

n denotes the value of "capability_nvideoin" and m denotes the value of "capability_nvideoinprofile"

NAME	VALUE	SECURITY (get/set)	DESCRIPTION
brightness <Not recommended to use this>	-5~5,100	4/4	-5: Darker <-> 5: Bright 100: Use " image_c<n>_brightnesspercent" * Only available when bit 0 of "capability_image_c<0~(n-1)>_basicse tting" is 1 * We replace "brightness" with "brightnesspercent". * This parameter will not be used after the version number (httpversion) is equal or greater than 0400a.
contrast <Not recommended to use this>	-5~5,100	4/4	-5: Less contrast <-> 5: More contrast 100: Use " image_c<0~(n-1)>_contrastpercent" * Only available when bit 1 of "capability_image_c<0~(n-1)>_basicse tting" is 1. * We replace "contrast" with "contrastpercent". * This parameter will not be used

NAME	VALUE	SECURITY (get/set)	DESCRIPTION
			after the version number (httpversion) is equal or greater than 0400a.
saturation <Not recommended to use this>	-5~5,100	4/4	-5: Less saturation <-> 5: More saturation 100: Use " image_c<n>_saturationpercent" * Only available when bit 2 of "capability_image_c<0~(n-1)>_basicsetting" is 1. * We replace "saturation" with "saturationpercent". * This parameter will not be used after the version number (httpversion) is equal or greater than 0400a.
sharpness <Not recommended to use this>	-3~3,100	4/4	-3: Softer <-> 3: Sharper 100: Use " image_c<0~(n-1)>_sharpnesspercent" * Only available when bit 3 of "capability_image_c<0~(n-1)>_basicsetting" is 1. * We replace "sharpness" with "sharpnesspercent". * This parameter will not be used after the version number (httpversion) is equal or greater than 0400a.
brightnesspercent	0~100	4/4	Set brightness in the normalized range. 0: Darker <-> 100: Bright * Only available when bit 0 of "capability_image_c<0~(n-1)>_basicsetting" is 1.
contrastpercent	0~100	4/4	Set contrast in the normalized range. 0: Less contrast <-> 100: More contrast * Only available when bit 1 of "capability_image_c<0~(n-1)>_basicsetting" is 1.

NAME	VALUE	SECURITY (get/set)	DESCRIPTION
			ting" is 1
saturationpercent	0~100	4/4	Set saturation in the normalized range. 0: Less saturation <-> 100: More saturation * Only available when bit 2 of "capability_image_c<0~(n-1)>_basicsetting" is 1.
sharpnesspercent	0~100	4/4	Set sharpness in the normalized range. 0: Softer <-> 100: Sharper * Only available when bit 3 of "capability_image_c<0~(n-1)>_basicsetting" is 1
gammacurve <product dependent>	0~100	4/4	0: Fine-tuned gamma curve by Vivotek. 1: Gamma value = 0.01 2: Gamma value = 0.02 3: Gamma value = 0.03 ... 100: Gamma value = 1 * Note: Although we set gamma value to 100 level, but not all gamma values are valid. Internal module will take the closest valid one. For example, 1~45 may all be mapped to gamma value = 0.45, etc. * Only available when "capability_image_c<0~(n-1)>_gammacurve" is 1
lowlightmode <product dependent>	<boolean>	4/4	Enable/disable low light mode. * Only available when "capability_image_c<0~(n-1)>_lowlightmode" is 1
hlm <product dependent>	<boolean>	4/4	Enable/disable highlight mask. * Only available when

NAME	VALUE	SECURITY (get/set)	DESCRIPTION
dependent>			"capability_image_c<0~(n-1)>_hlm" is 1
dnr_mode <product dependent>	<boolean>	4/4	3D noise reduction. 0:disable 1:enable * Only available when "capability_image_c<0~(n-1)>_dnr" is 1
dnr_strength <product dependent>	1~100	4/4	Strength of 3DNR * Only available when "capability_image_c<0~(n-1)>_dnr" is 1
defog_mode <product dependent>	<boolean>	4/4	Enable/disable defog mode. 0:disable 1:enable * Only available when "capability_image_c<0~(n-1)>_defog_mode" is 1
defog_strength <product dependent>	1~100	4/4	Strength of defog * Only available when "capability_image_c<0~(n-1)>_defog_mode" is 1
eis_mode <product dependent>	<boolean>	4/4	Electronic image stabilizer 0:disable 1:enable * Only available when 'eis' is listed in "capability_image_c<0~(n-1)>_is_mode".
eis_strength <product dependent>	1~100	4/4	Strength of electronic image stabilizer * Only available when 'eis' is listed in "capability_image_c<0~(n-1)>_is_mode".
dis_mode <product dependent>	<boolean>	4/4	Digital image stabilizer 0:disable 1:enable * Only available when 'dis' is listed in

NAME	VALUE	SECURITY (get/set)	DESCRIPTION
			"capability_image_c<0~(n-1)>_is_mod e".
dis_strength <product dependent>	1~100	4/4	Strength of digital image stabilizer * Only available when 'dis' is listed in "capability_image_c<0~(n-1)>_is_mod e".
scene_mode <product dependent>	Av)	4/4	Value of scene mode * Only available when "capability_image_c<0~(n-1)>_scene mode_support" is 1
restoreatwb	<positive integer>	4/4	Restore of adjusting white balance of image according to mode settings
freeze <product dependent>	<boolean>	4/4	Enable/disable Image freeze while patrolling. 0: disable 1: enable * Only available when "capability_image_c<0~(n-1)>_freeze" is 1
deinterlace_enable	<boolean>	4/4	Enable/disable deinterlace function. 0: disable 1: enable * Only available when "capability_image_c<0~(n-1)>_deinter lace_support" is 1.
deinterlace_mode	spatial,blend	4/4	Users can choose between two different deinterlacing techniques: Spatical mode provides the best image quality, while Blend mode provides better image quality (than not using the deinterlace function at all). * Only available when "capability_image_c<0~(n-1)>_deinter lace_support" is 1.
xoffset	0~100	4/4	Adjusting the image to proper

NAME	VALUE	SECURITY (get/set)	DESCRIPTION
			position horizontally. * Only available when the bit 4 of capability_image_c<0~(n-1)>_basicsetting is 1.
yoffset	0~100	4/4	Adjusting the image to proper position vertically. * Only available when the bit 5 of capability_image_c<0~(n-1)>_basicsetting is 1.
lens_alignment	0~100	4/4	Stitch the sensors together into focused position. * Only available when "capability_image_c<0~(n-1)>_lens_alignment" is 1.
lens_ldc_mode	<boolean>	4/4	Enable/disable lens distortion correction. * Only available when "capability_image_c<0~(n-1)>_lens_ldc_support" is 1.
palette_mode	Available value is listed in "capability_image_c<0~(n-1)>_palette_mode"	1/4	Set color palette option. * Only available when "capability_image_c<0~(n-1)>_palette_support" is 1. * Not support "policy=day" anymore when the version number (httpversion) is equal or greater than 0310a.
profile_i<0~(m-1)>_enable	<boolean>	4/4	Enable/disable this profile setting
profile_i<0~(m-1)>_policy	night, schedule	4/4	The mode which the profile is applied to. * Not support "policy=day" anymore when the version number

NAME	VALUE	SECURITY (get/set)	DESCRIPTION
			(httpversion) is equal or greater than 0301a.
profile_i<0~(m-1)> _begintime	hh:mm	4/4	Begin time of schedule mode.
profile_i<0~(m-1)> _endtime	hh:mm	4/4	End time of schedule mode.
profile_i<0~(m-1)> _brightness <Not recommended to use this>	-5~5,100	4/4	-5: Darker <-> 5: Bright 100: Use " image_c<0~(n-1)>_brightnesspercent" * Only available when bit 0 of "capability_image_c<0~(n-1)>_basicse tting" is 1 * We replace "profile_i0_brightness" with "profile_i0_brightnesspercent". * This parameter will not be used after the version number (httpversion) is equal or greater than 0400a.
profile_i<0~(m-1)> _contrast <Not recommended to use this>	-5~5,100	4/4	-5: Less contrast <-> 5: More contrast 100: Use " image_c<0~(n-1)>_contrastpercent" * Only available when bit 1 of "capability_image_c<0~(n-1)>_basicse tting" is 1. * We replace "profile_i0_contrast" with "profile_i0_contrastpercent". * This parameter will not be used after the version number (httpversion) is equal or greater than 0400a.
profile_i<0~(m-1)> _saturation <Not recommended to use this>	-5~5,100	4/4	-5: Less saturation <-> 5: More saturation 100: Use " image_c<0~(n-1)>_saturationpercent"

NAME	VALUE	SECURITY (get/set)	DESCRIPTION
use this>			<p>* Only available when bit 2 of "capability_image_c<0~(n-1)>_basicsetting" is 1.</p> <p>* We replace "profile_i0_saturation" with "profile_i0_saturationpercent".</p> <p>* This parameter will not be used after the version number (httpversion) is equal or greater than 0400a.</p>
profile_i<0~(m-1)>_sharpness <Not recommended to use this>	-3~3,100	4/4	<p>-5: Less saturation <-> 5: More saturation 100: Use "image_c<0~(n-1)>_saturationpercent"</p> <p>* Only available when bit 2 of "capability_image_c<0~(n-1)>_basicsetting" is 1.</p> <p>* We replace "profile_i0_saturation" with "profile_i0_saturationpercent".</p> <p>* This parameter will not be used after the version number (httpversion) is equal or greater than 0400a.</p>
profile_i<0~(m-1)>_brightnesspercent	0~100	4/4	<p>Set brightness in the normalized range. 0: Darker <-> 100: Bright</p> <p>* Only available when bit 0 of "capability_image_c<0~(n-1)>_basicsetting" is 1.</p>
profile_i<0~(m-1)>_contrastpercent	0~100	4/4	<p>Set contrast in the normalized range. 0: Less contrast <-> 100: More contrast</p> <p>* Only available when bit 1 of "capability_image_c<0~(n-1)>_basicsetting" is 1</p>

NAME	VALUE	SECURITY (get/set)	DESCRIPTION
profile_i<0~(m-1)> _saturationpercent	0~100	4/4	Set saturation in the normalized range. 0: Less saturation <-> 100: More saturation * Only available when bit 2 of "capability_image_c<0~(n-1)>_basicsetting" is 1.
profile_i<0~(m-1)> _sharpnesspercent	0~100	4/4	Set sharpness in the normalized range. 0: Softer <-> 100: Sharper * Only available when bit 3 of "capability_image_c<0~(n-1)>_basicsetting" is 1
profile_i<0~(m-1)> _gammacurve	0~100	4/4	0: Fine-tuned gamma curve by Vivotek. 1: Gamma value = 0.01 2: Gamma value = 0.02 3: Gamma value = 0.03 ... 100: Gamma value = 1 * Note: Although we set gamma value to 100 level, but not all gamma values are valid. Internal module will take the closest valid one. For example, 1~45 may all be mapped to gamma value = 0.45, etc. * Only available when "capability_image_c<0~(n-1)>_gammacurve" is 1
profile_i<0~(m-1)> _lowlightmode <product dependent>	<boolean>	4/4	Enable/disable low light mode. * Only available when "capability_image_c<0~(n-1)>_lowlightmode" is 1
profile_i<0~(m-1)> _hlm <product	<boolean>	4/4	Enable/disable highlight mask. * Only available when "capability_image_c<0~(n-1)>_hlm" is

NAME	VALUE	SECURITY (get/set)	DESCRIPTION
dependent>			1
profile_i<0~(m-1)> _dnr_mode <product dependent>	<boolean>	4/4	3D noise reduction. 0:disable 1:enable * Only available when "capability_image_c<0~(n-1)>_dnr" is 1
profile_i<0~(m-1)> _dnr_strength <product dependent>	1~100	4/4	Strength of 3DNR * Only available when "capability_image_c<0~(n-1)>_dnr" is 1
profile_i<0~(m-1)> _defog_mode <product dependent>	<boolean>	4/4	Enable/disable defog mode. 0:disable 1:enable * Only available when "capability_image_c<0~(n-1)>_defog_ mode" is 1
profile_i<0~(m-1)> _defog_strength <product dependent>	1~100	4/4	Strength of defog * Only available when "capability_image_c<0~(n-1)>_defog_ mode" is 1
profile_i<0~(m-1)> _eis_mode <product dependent>	<boolean>	4/4	Electronic image stabilizer 0:disable 1:enable * Only available when 'eis' is listed in "capability_image_c<0~(n-1)>_is_mod e".
profile_i<0~(m-1)> _eis_strength <product dependent>	1~100	4/4	Strength of electronic image stabilizer * Only available when 'eis' is listed in "capability_image_c<0~(n-1)>_is_mod e".
profile_i<0~(m-1)> _dis_mode <product dependent>	<boolean>	4/4	Digital image stabilizer 0:disable 1:enable * Only available when 'dis' is listed in "capability_image_c<0~(n-1)>_is_mod

NAME	VALUE	SECURITY (get/set)	DESCRIPTION
			e".
profile_i<0~(m-1)> _dis_strength <product dependent>	1~100	4/4	Strength of digital image stabilizer * Only available when 'dis' is listed in "capability_image_c<0~(n-1)>_is_mod e".

7.12 Exposure Window Setting per Channel

Group: **exposurewin_c<0~(n-1)>** for n channel products

n denotes the value of "capability_nvideoin"

(Only available when "capability_image_c<0~(n-1)>_exposure_mode"=1)

NAME	VALUE	SECURITY (get/set)	DESCRIPTION
mode	auto, custom,blc,hlc,center * Available values are listed in "capability_image_c<0~(n-1) >_exposure_winmode"	4/4	" auto ": Use full image view as the only exposure window. " custom ": Use custom windows. " blc ": Use BLC(Back Light Compensation), and the only exposure window is located at the center of view. " hlc ": Use HLC (High Light Compensation), and to perform the masking of bright light area. " center ": Use Center window as metering area and give the necessary light compensation.

Group: **exposurewin_c<0~(n-1)>_win_i<0~(k-1)>**

n denotes the value of "capability_nvideoin",

k denotes the value of "capability_image_c<0~(n-1)>_exposure_winnum".

(Only available when "capability_image_c<0~(n-1)>_exposure_mode"=1 and when custom is listed
in "capability_image_c<0~(n-1)>_exposure_winmode" and valid when
"exposurewin_c<0~(n-1)>_mode"=custom or "exposurewin_c<0~(n-1)>_mode"=hlc)

NAME	VALUE	SECURITY (get/set)	DESCRIPTION
enable	<boolean>	4/4	Enable or disable the window.

NAME	VALUE	SECURITY (get/set)	DESCRIPTION
policy	0~1	4/4	0: Indicate exclusive. 1: Indicate inclusive. * Only available when exclusive is listed in "capability_image_c<0~(n-1)>_exposure_wintype".
home	<0~320,0~240>	4/4	Left-top corner coordinate of the window. * Only available when qvga is listed in "capability_image_c<0~(n-1)>_exposure_windomain".
size	<0~320x0~240>	4/4	Width and height of the window. * Only available when qvga is listed in "capability_image_c<0~(n-1)>_exposure_windomain".
homepx	<0~W,0~H> W: 0~ The current image width -1 H: 0~ The current image height -1	4/4	Left-top corner coordinate of the window. * Only available when px is listed in "capability_image_c<0~(n-1)>_exposure_windomain".
sizepx	<0~Wx0~ H> W: 0~ The current image width -1 H: 0~ The current image height -1	4/4	Width and height of the window. * Only available when px is listed in "capability_image_c<0~(n-1)>_exposure_windomain".
homestd	<0~9999,0~9999>	4/4	Left-top corner coordinate of the window. * Only available when std is listed in "capability_image_c<0~(n-1)>_exposure_windomain".
sizestd	<0~9999x0~9999>	4/4	Width and height of the window.

NAME	VALUE	SECURITY (get/set)	DESCRIPTION
			* Only available when std is listed in "capability_image_c<0~(n-1)>_exposure_windomain".

Group: **exposurewin_c<0~(n-1)>_profile_i<0~(m-1)>** for n channel product and m profile, n denotes the value of "capability_nvideoin", m denotes the value of "capability_nvideoinprofile", (Only available when "capability_image_c<0~(n-1)>_exposure_mode"=1)

NAME	VALUE	SECURITY (get/set)	DESCRIPTION
mode	auto, custom,blc,hlc,center * Available values are listed in "capability_image_c<0~(n-1)>_exposure_winmode"	4/4	The mode indicates how to decide the exposure. "auto" : Use full view as the only one exposure window. "custom" : Use inclusive and exclusive window. "blc" : Use BLC(Back Light Compensation), and the only exposure window is located at the center of view. "hlc" : Use HLC (High Light Compensation), and to perform the masking of bright light area. "center" : Use Center window as metering area and give the necessary light compensation.

Group: **exposurewin_c<0~(n-1)>_profile_i<0~(m-1)>_win_i<0~(k-1)>** for m profile and n channel product, n denotes the value of "capability_nvideoin", m denotes the value of "capability_nvideoinprofile", k denotes the value of "capability_image_c<0~(n-1)>_exposure_winnum". (Only available when "capability_image_c<0~(n-1)>_exposure_mode"=1 and when custom is listed in "capability_image_c<0~(n-1)>_exposure_winmode" and valid when "exposurewin_c<0~(n-1)>_mode"=custom or "exposurewin_c<0~(n-1)>_mode"=hlc)

NAME	VALUE	SECURITY (get/set)	DESCRIPTION
------	-------	-----------------------	-------------

NAME	VALUE	SECURITY (get/set)	DESCRIPTION
enable	<boolean>	4/4	Enable or disable the window.
policy	0~1	4/4	0: Indicate exclusive. 1: Indicate inclusive. * Only available when exclusive is listed in "capability_image_c<0~(n-1)>_exposure_wintype".
home	<0~320,0~240>	4/4	Left-top corner coordinate of the window. * Only available when qvga is listed in "capability_image_c<0~(n-1)>_exposure_windomain".
size	<0~320x0~240>	4/4	Width and height of the window. * Only available when qvga is listed in "capability_image_c<0~(n-1)>_exposure_windomain".
homepx	<0~W,0~H> W: 0~ The current image width -1 H: 0~ The current image height -1	4/4	Left-top corner coordinate of the window. * Only available when px is listed in "capability_image_c<0~(n-1)>_exposure_windomain".
sizepx	<0~Wx0~ H> W: 0~ The current image width -1 H: 0~ The current image height -1	4/4	Width and height of the window. * Only available when px is listed in "capability_image_c<0~(n-1)>_exposure_windomain".
homestd	<0~9999,0~9999>	4/4	Left-top corner coordinate of the window. * Only available when std is listed in "capability_image_c<0~(n-1)>_exposure_windomain".
sizestd	<0~9999x0~9999>	4/4	Width and height of the window.

NAME	VALUE	SECURITY (get/set)	DESCRIPTION
			* Only available when std is listed in "capability_image_c<0~(n-1)>_exposure_windomain".

7.13 Audio Input per Channel

Group: **audioin_c<0~(n-1)>** (**capability_naudioin>0**)

n denotes the value of "capability_naudioin"

NAME	VALUE	SECURITY (get/set)	DESCRIPTION
source <Not recommended to use this>	micin, linein <product dependent>	4/4	micin => use built-in microphone input. linein => use external microphone input. * Reserved for compatibility, and suggest don't use this since the version number (httpversion) is equal or greater than 0301a. * We replace "source" with "input". More details, please refer the parameter description of "input".
input	intmic, extmic <product dependent>	4/4	intmic: Internal (built-in) microphone. (Only available when capability_audio_intmic = 1) extmic: External microphone input. (Only available when capability_audio_extmic =1) * Note: If physical microphone switch is showed on product, this value is updated during booting to fit switch status.
volume_internal	0~100	4/4	Volume when take internal microphone as input source. 0: Minimum 100: Maximum

NAME	VALUE	SECURITY (get/set)	DESCRIPTION
			* Only available when the channel supports internal microphone (The related bit of "capability_audio_intmic" is equal to 1).
volume_external	0~100	4/4	Volume when take external microphone as input source. 0: Minimum 100: Maximum * Only available when the channel supports external microphone (The related bit of "capability_audio_extmic" is equal to 1).
mute	0, 1	1/4	0: Mute off 1: Mute on
gain <Not recommended to use this>	0~100	4/4	Gain of input. (audioin_c<0~(n-1)>_source = linein) * Reserved for compatibility, and suggest don't use this since the version number (httpversion) is equal or greater than 0301a. * We replace "gain" with "volume_internal" and "volume_external". More details, please refer the parameter description of "volume_internal" and "volume_external".
boostmic <Not recommended to use this>	0~100	4/4	Enable microphone boost. Gain of input. (audioin_c<0~(n-1)>_source = micin) * Reserved for compatibility, and suggest don't use this since the version number (httpversion) is equal

NAME	VALUE	SECURITY (get/set)	DESCRIPTION
			or greater than 0301a. * We replace "boostmic" with "volume_internal" and "volume_external". More details, please refer the parameter description of "volume_internal" and "volume_external".
s0_codecype	aac4, gamr, g711, g726 (Available codec are listed in "capability_audioin_codec")	4/4	Set audio codec type for input. aac4: Advanced Audio Coding (AAC) gamr: Adaptive Multi-Rate (AMR) g711: G.711 g726: G.726
s0_aac4_bitrate	16000, 32000, 48000, 64000, 96000, 128000	4/4	Set AAC4 bitrate in bps. * Only available if AAC is supported.
s0_gamr_bitrate	4750, 5150, 5900, 6700, 7400, 7950, 10200, 12200	4/4	AMR encoded bitrate in bps. * Only available if AMR is supported.
s0_g711_mode	pcmu, pcma	4/4	Set G.711 companding algorithm. pcmu: μ -law algorithm pcma: A-law algorithm * Only available if G.711 is supported.
s0_g726_bitrate	16000, 24000, 32000, 40000	4/4	Set G.726 encoded bitrate in bps. * Only available if G.726 is supported.
s0_g726_bitstreamamp	little, big	4/4	Set G.726 bit streaming packing

NAME	VALUE	SECURITY (get/set)	DESCRIPTION
ackingmode			mode. little: Little-endian bitstream format. big: Big-endian bitstream format. * Only available if G.726 is supported.
s0_g726_vlcmode	0, 1	4/4	Enable vlcmode for G.726. 0: Standard mode. 1: Solve compatibility problem with VLC player. * Only available if G.726 is supported.
aec_enable	<boolean>	4/4	Enable acoustic echo cancellation. * Only available when "capability_audio_aecmode" is "manual". * We support this parameter when the version number (httpversion) is equal or greater than 0306b.
alarm_enable	<boolean>	4/4	Enable audio detection
alarm_level	1~100	4/4	Audio detection alarm level
profile_i0_enable	<boolean>	4/4	Enable/disable this profile setting
profile_i0_policy	night, schedule	4/4	The mode which the profile is applied to. * Not support "policy=day" anymore when the version number (httpversion) is equal or greater than 0301a.
profile_i0_begintime	hh:mm	4/4	Begin time of schedule mode.
profile_i0_endtime	hh:mm	4/4	End time of schedule mode.
profile_i0_alarm_level	1~100	4/4	Audio detection alarm level

7.14 Audio Output per Channel

Group: `audioout_c<0~(n-1)>` for n channel products (`capability_audio_audioclip=1`)

n denotes the value of "capability_nvideoin"

NAME	VALUE	SECURITY (get/set)	DESCRIPTION
volume	0~100	4/4	Adjusting audio volume

7.15 Play an Audio Clip

Group: `audioclip_i<0~1>` (`capability_audio_audioclip=1`)

NAME	VALUE	SECURITY (get/set)	DESCRIPTION
name	string[40]	1/4	Specify the audio clip name that can be played when an event occurs.
size	0,<positive integer>	1/4	The size of audio clip.
prerecord_seconds	1~10	1/4	Indicates the seconds that can be waited before audio clip start to record.

7.16 Motion Detection Settings

Group: **motion_c<0~(n-1)>** for n channel products

n denotes the value of "capability_nvideoin"

NAME	VALUE	SECURITY (get/set)	DESCRIPTION
enable	<boolean>	4/4	Enable motion detection.
win_sensitivity	0 ~ 100	4/4	Sensitivity of all motion detection windows. * The value "0" is reserved for compatibility and will not be used after the version number (httpversion) is equal or greater than 0400a.

Group: **motion_c<0~(n-1)>_win_i<0~(k-1)>**

n denotes the value of "capability_nvideoin", k denotes the value of "capability_nmotion".

NAME	VALUE	SECURITY (get/set)	DESCRIPTION
enable	<boolean>	4/4	Enable motion detection window.
name	string[14]	4/4	Name of motion window.
polygonstd	0 ~ 9999,0 ~ 9999, 0 ~ 9999,0 ~ 9999, 0 ~ 9999,0 ~ 9999	4/4	Coordinate of polygon window position. (4 points: x0,y0,x1,y1,x2,y2,x3,y3) * Only available when "capability_motion_wintype" = polygon. * Only available when std is listed in "capability_motion_windomain"
objsize	1 ~ 100	4/4	Percent of motion detection window.
sensitivity <Not recommended to use this>	0 ~ 100	4/4	Sensitivity of motion detection window. * We replace "sensitivity" with "win_sensitivity". * This parameter will not be used after the version number (httpversion) is equal or greater than 0400a.
polygonpx <Not recommended to use this>	0 ~ W,0 ~ H, 0 ~ W,0 ~ H, 0 ~ W,0 ~ H, 0 ~ W,0 ~ H	4/4	Coordinate of polygon window position.

NAME	VALUE	SECURITY (get/set)	DESCRIPTION
to use this>	W,0 ~ H W: 0~ The current image width -1 H: 0~ The current image height -1		(4 points: x0,y0,x1,y1,x2,y2,x3,y3) * Only available when "capability_motion_wintype" = polygon. * Only available when px is listed in "capability_motion_windomain". * It's recommended to use polygonsd * This parameter will not be used after the version number (httpversion) is equal or greater than 0400a.
polygon <Not recommended to use this>	0 ~ 320,0 ~ 240, 0 ~ 320,0 ~ 240, 0 ~ 320,0 ~ 240, 0 ~ 320,0 ~ 240	4/4	Coordinate of polygon window position. (4 points: x0,y0,x1,y1,x2,y2,x3,y3) * Only available when "capability_motion_wintype" = polygon. * Only available when qvga is listed in "capability_motion_windomain". * It's recommended to use polygonsd * This parameter will not be used after the version number (httpversion) is equal or greater than 0400a.
left <Not recommended to use this>	0 ~ 320	4/4	Left coordinate of window position. * Only available when "capability_motion_wintype" = rectangle. * Only available when qvga is listed in "capability_motion_windomain". * It's recommended to use polygonsd * This parameter will not be used after the version number (httpversion) is equal or greater than 0400a.
top <Not recommended to use this>	0 ~ 240	4/4	Top coordinate of window position. * Only available when "capability_motion_wintype" = rectangle.

NAME	VALUE	SECURITY (get/set)	DESCRIPTION
			<ul style="list-style-type: none"> * Only available when qvga is listed in "capability_motion_windomain". * It's recommended to use polygonsd * This parameter will not be used after the version number (httpversion) is equal or greater than 0400a.
width <Not recommended to use this>	0 ~ 320	4/4	<p>Width of motion detection window.</p> <ul style="list-style-type: none"> * Only available when "capability_motion_wintype" = rectangle. * Only available when qvga is listed in "capability_motion_windomain". * It's recommended to use polygonsd * This parameter will not be used after the version number (httpversion) is equal or greater than 0400a.
height <Not recommended to use this>	0 ~ 240	4/4	<p>Height of motion detection window.</p> <ul style="list-style-type: none"> * Only available when "capability_motion_wintype" = rectangle. * Only available when qvga is listed in "capability_motion_windomain". * It's recommended to use polygonsd * This parameter will not be used after the version number (httpversion) is equal or greater than 0400a.

Group: **motion_c<0~(n-1)>_profile_i<0~(m-1)>** for m profile and n channel product, n denotes the value of "capability_nvideoin", m denotes the vaule of " capability_nmotionprofile ", (**capability_nmotionprofile > 0**)

NAME	VALUE	SECURITY (get/set)	DESCRIPTION
enable	<boolean>	4/4	Enable profile 1 ~ (m-1).
policy	night, schedule	4/4	The mode which the profile is applied to.

NAME	VALUE	SECURITY (get/set)	DESCRIPTION
			* Not support "policy=day" anymore when the version number (httpversion) is equal or greater than 0301a.
begintime	hh:mm	4/4	Begin time of schedule mode.
endtime	hh:mm	4/4	End time of schedule mode.
win_sensitivity	0 ~ 100	4/4	Sensitivity of all motion detection windows. * The value "0" is reserved for compatibility and will not be used after the version number (httpversion) is equal or greater than 0400a.

Group: `motion_c<0~(n-1)>_profile_i<0~(m-1)>_win_i<0~(k-1)>` for m profile and n channel product,

n denotes the value of "capability_nvideoin", m denotes the value of "capability_nmotionprofile", k denotes the value of "capability_nmotion".

NAME	VALUE	SECURITY (get/set)	DESCRIPTION
enable	<boolean>	4/4	Enable motion detection window.
name	string[14]	4/4	Name of motion window.
polygonstd	0 ~ 9999,0 ~ 9999, 0 ~ 9999,0 ~ 9999, 0 ~ 9999,0 ~ 9999, 0 ~ 9999,0 ~ 9999	4/4	Coordinate of polygon window position. (4 points: x0,y0,x1,y1,x2,y2,x3,y3) * Only available when "capability_motion_wintype" = polygon. * Only available when std is listed in "capability_motion_windomain"
objsize	1 ~ 100	4/4	Percent of motion detection window.
sensitivity <Not recommended to use this>	0 ~ 100	4/4	Sensitivity of motion detection window. * We replace "sensitivity" with "win_sensitivity". * This parameter will not be used after the version number (httpversion) is equal or greater than 0400a.
polygonpx	0 ~ W,0 ~ H, 0 ~	4/4	Coordinate of polygon window position.

NAME	VALUE	SECURITY (get/set)	DESCRIPTION
<Not recommended to use this>	W,0 ~ H, 0 ~ W,0 ~ H, 0 ~ W,0 ~ H W: 0~ The current image width -1 H: 0~ The current image height -1		(4 points: x0,y0,x1,y1,x2,y2,x3,y3) * Only available when "capability_motion_wintype" = polygon. * Only available when px is listed in "capability_motion_windomain". * It's recommended to use polygonsd * This parameter will not be used after the version number (httpversion) is equal or greater than 0400a.
polygon <Not recommended to use this>	0 ~ 320,0 ~ 240, 0 ~ 320,0 ~ 240, 0 ~ 320,0 ~ 240, 0 ~ 320,0 ~ 240	4/4	Coordinate of polygon window position. (4 points: x0,y0,x1,y1,x2,y2,x3,y3) * Only available when "capability_motion_wintype" = polygon. * Only available when qvga is listed in "capability_motion_windomain". * It's recommended to use polygonsd * This parameter will not be used after the version number (httpversion) is equal or greater than 0400a.
left <Not recommended to use this>	0 ~ 320	4/4	Left coordinate of window position. * Only available when "capability_motion_wintype" = rectangle. * Only available when qvga is listed in "capability_motion_windomain". * It's recommended to use polygonsd * This parameter will not be used after the version number (httpversion) is equal or greater than 0400a.
top <Not recommended to use this>	0 ~ 240	4/4	Top coordinate of window position. * Only available when "capability_motion_wintype" = rectangle. * Only available when qvga is listed in "capability_motion_windomain". * It's recommended to use polygonsd

NAME	VALUE	SECURITY (get/set)	DESCRIPTION
			* This parameter will not be used after the version number (httpversion) is equal or greater than 0400a.
width <Not recommended to use this>	0 ~ 320	4/4	Width of motion detection window. * Only available when "capability_motion_wintype" = rectangle. * Only available when qvga is listed in "capability_motion_windomain". * It's recommended to use polygonsd * This parameter will not be used after the version number (httpversion) is equal or greater than 0400a.
height <Not recommended to use this>	0 ~ 240	4/4	Height of motion detection window. * Only available when "capability_motion_wintype" = rectangle. * Only available when qvga is listed in "capability_motion_windomain". * It's recommended to use polygonsd * This parameter will not be used after the version number (httpversion) is equal or greater than 0400a.

7.17 Tampering Detection Settings

Group: **tampering_c<0~(n-1)>** for n channel products (**capability_tampering > 0**)

n denotes the value of "capability_nvideoin"

NAME	VALUE	SECURITY (get/set)	DESCRIPTION
enable	<boolean>	4/4	Enable or disable tamper detection.
threshold	0~100	4/4	Threshold of tamper detection.
duration	10~600	4/4	If tampering value exceeds the "threshold" for more than "duration" second(s), then tamper detection is triggered.
ignorewidth	0,<positive integer>	1/7	Indicate the width to offset to start to analysis the image.
dark_enable	<boolean>	4/4	Enable or disable image too dark detection
dark_threshold	0~100	4/4	Threshold of image too dark detection
dark_duration	1~10	4/4	If image too dark value exceeds the "threshold" for more than "duration" second(s), then image too dark detection is triggered.
bright_enable	<boolean>	4/4	Enable or disable image too bright detection
bright_threshold	0~100	4/4	Threshold of image too bright detection
bright_duration	1~10	4/4	If image too bright value exceeds the "threshold" for more than "duration" second(s), then image too bright detection is triggered.
blurry_enable	<boolean>	4/4	Enable or disable image too blurry detection
blurry_threshold	0~100	4/4	Threshold of image too blurry detection
blurry_duration	1~10	4/4	If image too blurry value exceeds the "threshold" for more than "duration" second(s), then image too blurry detection is triggered.

7.18 DDNS

Group: **ddns** (*capability_protocol_ddns > 0*)

NAME	VALUE	SECURITY (get/set)	DESCRIPTION
enable	<boolean>	6/6	Enable or disable the dynamic DNS.
provider	DyndnsDynamic, DyndnsCustom, Safe100	6/6	DyndnsDynamic => dyndns.org (dynamic) DyndnsCustom => dyndns.org Safe100 => safe100.net
<provider>_hostname	string[128]	6/6	Your DDNS hostname.
<provider>_username	string[64]	6/6	Your user name or email to login to the DDNS service provider
<provider>_password	string[64]	7/6	Your password or key to login to the DDNS service provider.

7.19 Express Link

Group: **expresslink**

PARAMETER	VALUE	SECURITY (get/set)	DESCRIPTION
enable	<boolean>	6/6	Enable or disable express link.
state	onlycheck, onlyoffline, checkonline, badnetwork	6/6	Camera will check the status of network environment and express link URL
url	string[64]	6/6	The url user define to link to camera

7.20 UPnP Presentation

Group: **upnppresentation**

NAME	VALUE	SECURITY (get/set)	DESCRIPTION
enable	<boolean>	6/6	Enable or disable the UPnP presentation service.

7.21 UPnP Port Forwarding

Group: **upnpportforwarding**

NAME	VALUE	SECURITY (get/set)	DESCRIPTION
enable	<boolean>	6/6	Enable or disable the UPnP port forwarding service.
upnpnatstatus	0~3	6/7	The status of UPnP port forwarding, used internally. 0 = OK, 1 = FAIL, 2 = no IGD router, 3 = no need for port forwarding

7.22 System Log

Group: **syslog**

NAME	VALUE	SECURITY (get/set)	DESCRIPTION
enableremotelog	<boolean>	6/6	Enable remote log.
serverip	<IP address>	6/6	Log server IP address.
serverport	514, 1025~65535	6/6	Server port used for log.
level	0~7	6/6	Levels used to distinguish the importance of the information: 0: LOG_EMERG 1: LOG_ALERT 2: LOG_CRIT 3: LOG_ERR 4: LOG_WARNING 5: LOG_NOTICE 6: LOG_INFO 7: LOG_DEBUG
setparamlevel	0~2	6/6	Show log of parameter setting. 0: disable 1: Show log of parameter setting set from external. 2. Show log of parameter setting set from external and internal.

7.23 SNMP

Group: **snmp** (*capability_protocol_snmp > 0*)

NAME	VALUE	SECURITY (get/set)	DESCRIPTION
v2	<boolean>	6/6	SNMP v2 enabled. 0 for disable, 1 for enable
v3	<boolean>	6/6	SNMP v3 enabled. 0 for disable, 1 for enable
secnamerw	string[31]	6/6	Read/write security name
secnamero	string[31]	6/6	Read only security name
authpwrw	string[8~128]	7/6	Read/write authentication password
authpwro	string[8~128]	7/6	Read only authentication password
authtyperw	MD5,SHA	6/6	Read/write authentication type
authtypero	MD5,SHA	6/6	Read only authentication type
encryptpwrw	string[8~128]	7/6	Read/write passwrđ
encryptpwro	string[8~128]	7/6	Read only password
encrypttyperw	DES	6/6	Read/write encryption type
encrypttypero	DES	6/6	Read only encryption type
rwcommunity	string[31]	6/6	Read/write community
rocommunity	string[31]	6/6	Read only community
syslocation	string[128]	6/6	System location
syscontact	string[128]	6/6	System contact

7.24 Layout Configuration

Group: **layout**

NAME	VALUE	SECURITY (get/set)	DESCRIPTION
logo_default	<boolean>	1/6	0 => Custom logo 1 => Default logo
logo_link	string[128] http://www.vivotek.com	1/6	Hyperlink of the logo
logo_powerbyvvtk_hidden	<boolean>	1/6	0 => display the power by vivotek logo 1 => hide the power by vivotek logo
custombutton_manualtrigger_show	<boolean>	1/6	Show or hide manual trigger (VI) button in homepage 0 -> Hidden 1 -> Visible
theme_option	1~4	1/6	1~3: One of the default themes. 4: Custom definition.
theme_color_font	string[7]	1/6	Font color
theme_color_configfont	string[7]	1/6	Font color of configuration area.
theme_color_titlefont	string[7]	1/6	Font color of video title.
theme_color_controlbackground	string[7]	1/6	Background color of control area.
theme_color_configbackground	string[7]	1/6	Background color of configuration area.
theme_color_videobackground	string[7]	1/6	Background color of video area.
theme_color_case	string[7]	1/6	Frame color

7.25 Privacy Mask

Group: **privacymask_c<0~(n-1)>** for n channel products and m privacy mask window.

n denotes the value of "capability_nvideoin" and m denotes the value of

"capability_videoin_c<0~(n-1)>_nprivacymask"

NAME	VALUE	SECURITY (get/set)	DESCRIPTION
enable	<boolean>	4/4	Enable privacy mask.
win_i<0~(m-1)>_enable	<boolean>	4/4	Enable privacy mask window.
win_i<0~(m-1)>_name	string[14]	4/4	Name of the privacy mask window.
win_i<0~(m-1)>_left	0 ~ 320	4/4	Left coordinate of window position. * Only available when "capability_image_c<0~(n-1)>_privacymask_wintype" = rectangle.
win_i<0~(m-1)>_top	0 ~ 240	4/4	Top coordinate of window position. * Only available when "capability_image_c<0~(n-1)>_privacymask_wintype" = rectangle.
win_i<0~(m-1)>_width	0 ~ 320	4/4	Width of privacy mask window. * Only available when "capability_image_c<0~(n-1)>_privacymask_wintype" = rectangle.
win_i<0~(m-1)>_height	0 ~ 240	4/4	Height of privacy mask window. * Only available when "capability_image_c<0~(n-1)>_privacymask_wintype" = rectangle.
win_i<0~(m-1)>_polygo n	0 ~ 320,0 ~ 240, 0 ~ 320,0 ~ 240, 0 ~ 320,0 ~ 240, 0 ~ 320,0 ~ 240	4/4	Coordinate of polygon window position. (4 points: x0,y0,x1,y1,x2,y2,x3,y3) * Only available when "capability_image_c<n>_privacymask_wintype" = polygon. * Only available when qvga is listed in "capability_image_c<0~(n-1)>_privacymask_windomain".
win_i<0~(m-1)>_polygo	0 ~ W,0 ~ H,	4/4	Coordinate of polygon window

NAME	VALUE	SECURITY (get/set)	DESCRIPTION
npx	0 ~ W, 0 ~ H, 0 ~ W, 0 ~ H, 0 ~ W, 0 ~ H W: 0 ~ The current image width -1 H: 0 ~ The current image height -1		position. (4 points: x0,y0,x1,y1,x2,y2,x3,y3) * Only available when "capability_image_c<0~(n-1)>_privacy mask_wintype" = polygon. * Only available when px is listed in "capability_image_c<0~(n-1)>_privacy mask_windomain".
win_i<0~(m-1)>_polygo nstd	0 ~ 9999, 0 ~ 9999, 0 ~ 9999, 0 ~ 9999, 0 ~ 9999, 0 ~ 9999, 0 ~ 9999, 0 ~ 9999	4/4	Coordinate of polygon window position. (4 points: x0,y0,x1,y1,x2,y2,x3,y3) * Only available when "capability_image_c<0~(n-1)>_privacy mask_wintype" = polygon. * Only available when std is listed in "capability_image_c<0~(n-1)>_privacy mask_windomain".

7.26 3D Privacy Mask

Group: **privacymask3d_c<0~(n-1)>** for n channel products and m privacy mask window.

(**capability_image_c<0~(n-1)>_privacymask_wintype = 3Drectangle**)

n denotes the value of "capability_nvideoin" and m denotes the value of "capability_videoin_c<0~(n-1)>_nprivacymask"

NAME	VALUE	SECURITY (get/set)	DESCRIPTION
enable	<boolean>	4/4	Enable the 3D privacy mask
color	0~" capability_image_c<0~(n-1)>_privacymask_ncolor" -1	4/4	Privacy mask color
win_i<0~(m-1)>_name	string[40]	4/4	Name of the privacy mask window.
win_i<0~(m-1)>_pan	"capability_ptz_c<0~(n-1)>_minpan" ~ "capability_ptz_c<0~(n-1)>_maxpan"	4/4	Pan position of window position. * Only available when bit0 of "capability_camctrl_c<0~(n-1)>_buildinpt" is "1"
win_i<0~(m-1)>_tilt	"capability_ptz_c<0~(n-1)>_mintilt" ~ "capability_ptz_c<0~(n-1)>_maxtilt"	4/4	Tilt position of window position. * Only available when bit1 of "capability_camctrl_c<0~(n-1)>_buildinpt" is "1"
win_i<0~(m-1)>_zoom	"capability_ptz_c<0~(n-1)>_minzoom" ~ "capability_ptz_c<0~(n-1)>_maxzoom"	4/4	Zoom position of window position.
win_i<0~(m-1)>_fliped	<boolean>	4/4	Flip side of window position. 0: Non-flip side 1: Flip side

7.27 Capability

Group: **capability**

NAME	VALUE	SECURITY (get/set)	DESCRIPTION
api_httpversion	<string> This number start with 0301a.	0/7	<p>The version of VIVOTEK WebAPI with 4 integers plus 1 alphabet, There are composed by "major version", "minor version", "revision", "_platform". ex: 0301a_1</p> <p><u>Major version</u> Increase the major version when change, remove the old features/interfaces or the firmware has substantially change in architecture and not able to roll back to previous version. This may cause incompatibility with supporting software.</p> <p><u>Minor version</u> Increase the minor version when add new features/interfaces without change the old features and interfaces.</p> <p><u>Revision</u> Increase the revision when fix bugs without change any features of the output.</p> <p><u>_platform</u> This is a constant, it is used to distinguish between different platforms</p> <p><u>API version format:</u> MMmmr_k Where "MM" is the major version, "mm" is the minor version and "r" is the revision.</p>

NAME	VALUE	SECURITY (get/set)	DESCRIPTION
			<p>'M' and 'm' and 'k' are decimal digit from 0 to 9, while 'r' is an alphabetic. EX: 0302b_1 => Major version = 03, minor version = 02, revision = b, platform = 1</p> <p>The 4 integer numbers are WebAPI version, we use short name: [httpversion] for it in this document. The 5th character is model-based version for API bug-fix and it's default to "a".</p> <p>Ex: If some APIs in a model does not follow the API definition of 0301a_1, we will fix them and change this API value to 0301b_1.</p>
bootuptime	<positive integer>	0/7	Server bootup time.
nir <Not support anymore>	0, <positive integer>	0/7	<p>Number of IR interfaces. (Recommand to use capability_daynight_c<0~"capability_nvideoin"-1>_builtinir for built-in IR and capability_daynight_c<0~"capability_nvideoin"-1>_externalir for external IR)</p> <p>* Not support this parameter anymore when the version number (httpversion) is equal or greater than 0301a.</p>
npir	0, <positive integer>	0/7	Number of PIRs.
ndi	0, <positive integer>	0/7	Number of digital inputs.
nvi	0, <positive integer>	0/7	Number of virtual inputs (manual trigger)
ndo	0, <positive integer>	0/7	Number of digital outputs.

NAME	VALUE	SECURITY (get/set)	DESCRIPTION
naudioin	0, <positive integer>	0/7	The number of audio input channel. 0 means no audio input support.
naudioout	0, <positive integer>	0/7	The number of audio output channel
nvideoin	<positive integer>	0/7	Number of video inputs.
nvideoout	0, <Positive Integer>	0/7	Number of video out interface.
nvideoinprofile	<positive integer>	0/7	Number of video input profiles.
nmediastream	<positive integer>	0/7	Number of media stream per channels.
naudiosetting <Not support anymore>	<positive integer>	0/7	Number of audio settings per channel. * Not support this parameter anymore when the version number (httpversion) is equal or greater than 0301a. * We replace "naudiosetting" with "naudioin". More details, please refer the parameter description of "volume_internal" and "volume_external".
nuart	0, <positive integer>	0/7	Number of UART interfaces.
nmotion	<positive integer>	0/7	The number of motion window.
nmotionprofile	0, <positive integer>	0/7	Number of motion profiles.
nevent	0, <positive integer>	0/7	Number of event. * We support this parameter when the version number (httpversion) is equal or greater than 0311c.
nrecording	0, <positive integer>	0/7	Number of recording. * We support this parameter when the version number (httpversion) is equal or greater than 0309a.
ptzenabled	0, <positive integer>	0/7	An 32-bit integer, each bit can be set separately as follows: Bit 0 => Support camera control

NAME	VALUE	SECURITY (get/set)	DESCRIPTION
			function; 0(not support), 1(support) Bit 1 => (only available when bit0 is 1) Built-in or external video source; 0(external), 1(built-in) Bit 2 => (only available when bit0 is 1) Support pan operation; 0(not support), 1(support) Bit 3 => (only available when bit0 is 1) Support tilt operation; 0(not support), 1(support) Bit 4 => (only available when bit0 is 1) Support zoom operation; 0(not support), 1(support) (only available when RS-485 interface is supported or SD/PZ/PT/PD/video server series) Bit 5 => (only available when bit0 is 1) Support focus operation; 0(not support), 1(support) (only available when RS-485 interface is supported or SD/PZ/PT/PD/video server series) Bit 6 => (only available when bit0 is 1) Reserved bit; always 0. Bit 7 => (only available when bit0 is 1) External or built-in PT; 0(built-in), 1(external)
windowless	<boolean>	0/7	Indicate whether to support windowless plug-in.
evctrlchannel	<boolean>	0/7	Indicate whether to support HTTP tunnel for event/control transfer.
joystick	<boolean>	0/7	Indicate whether to support joystick control.
remotefocus <Not	0,<positive integer>	0/7	An 4-bit integer, which indicates the supportive application of

NAME	VALUE	SECURITY (get/set)	DESCRIPTION
recommended to use this>			<p>remotefocus.</p> <p>If the value of this parameter is larger than 0, it means that the camera supports remotefocus function.</p> <p>bit 0 => Indicate whether to support both zoom and focus function.</p> <p>bit 1 => Only support zoom function.</p> <p>bit 2 => Only support focus function.</p> <p>bit 3 => Currently, this is a reserved bit, and the default value is 0.</p> <p>* It's strongly non-recommended to use this.</p> <p>* This is reserved for compatibility and will not be used after the version number (httpversion) is equal or greater than 0400a.</p> <p>* We replace "capability_remotefocus" with "capability_image_c0_remotefocus".</p>
npreset	0, <positive integer>	0/7	Number of preset locations
presettourdirection	<boolean>	0/7	<p>Indicate whether to support preset tour direction function. It means users can choose which direction the preset tour goes.</p> <p>* We support this parameter when the version number (httpversion) is equal or greater than 0307a.</p>
eptz	0, <positive integer>	0/7	<p>For "nvideoin" = 1, the definition is as following:</p> <p>A 32-bits integer, each bit can be set separately as follows:</p> <p>Bit 0 => 1st stream supports ePTZ or not.</p> <p>Bit 1 => 2nd stream supports ePTZ or not, and so on.</p>

NAME	VALUE	SECURITY (get/set)	DESCRIPTION
			<p>For nvideoin ≥ 2, the definition is different:</p> <p>First all 32 bits are divided into groups for channel.</p> <p>Ex:</p> <p>nvideoin = 2, bit 0~15 are the 1st group for 1st channel, bit 16~31 are the 2nd group for 2nd channel.</p> <p>nvideoin = 3, bit 0~9 are the 1st group for 1st channel, bit 10~19 are the 2nd group for 2nd channel, bit 20~31 are the 3rd group for 3rd channel.</p> <p>Then, the 1st bit of the group indicates 1st stream of a channel support ePTZ or not. The 2nd bit of the group indicates 2nd stream of a channel support ePTZ or not, and so on.</p> <p>* For most products, the last stream of a channel will not support ePTZ. It is reserved for full view of the channel. For some dual-stream products, both streams support ePTZ.</p>
nanystream	0, <positive integer>	0/7	number of any media stream per channel
iva	<boolean>	0/7	Indicate whether to support Intelligent Video analysis
whitelight <Not recommended to use this>	<boolean>	0/7	<p>Indicate whether to support white light led.</p> <p>* We replace this parameter with "capability_daynight_c<0~(n-1)>_built_inwled" when the version number (httpversion) is equal or greater than 0309d.</p>
iris	<boolean>	0/7	Indicate whether to support iris control.

NAME	VALUE	SECURITY (get/set)	DESCRIPTION
supportsd	<boolean>	0/7	Indicate whether to support local storage.
fisheye	<boolean>	0/7	The parameter is used to determine whether the product is fisheye or not.
tampering	<boolean>	0/7	Indicate whether to support tampering detection.
tamperingmode	tamper,toodark,toobright,tooblurry	0/7	Available tampering mode list. * Only available when "capability_tampering" is 1.
adaptiverecording	<boolean>	0/7	Indicate whether to support adaptive recording.
adaptivestreaming	<boolean>	0/7	Indicate whether to support adaptive streaming.
supporttriggertypes	seq,boot,motion,networkfail,recnotify,tampering,vi,vadp,di,volalarm,temperature,pir,visignal,backup,smartsd,shockalarm,virestore <product dependent>	0/7	list all the trigger types which are supported in the camera: "seq" = Periodic condition "boot" = System boot "motion" = Video motion detection "networkfail" = network connection failure "recnotify" = Recording notification. "tampering" = Tamper detection. "vi" = Virtual input (Manual trigger) "vadp" = VADP trigger. "di" = Digital input. "volalarm" = Audio detection. "temperature" = Temperature detection. "pir" = PIR detection. "visignal" = Video input signal loss. "backup" = Backing up recorded files. "smartsd" = Lifetime detection of SD card. "shockalarm" = Shock detection. "virestore" = Video input signal restore.

NAME	VALUE	SECURITY (get/set)	DESCRIPTION
			* Only available when [httpversion] >= 0301a
media_num	0,<positive integer>	0/7	Number of media number. * We support this parameter when the version number (httpversion) is equal or greater than 0311c.
storage_dbenabled	<boolean>	0/7	Media files are indexed in database.
protocol_https	< boolean >	0/7	Indicate whether to support HTTP over SSL.
protocol_rtsp	< boolean >	0/7	Indicate whether to support RTSP.
protocol_sip	<boolean>	0/7	Indicate whether to support SIP.
protocol_maxconn ection	<positive integer>	0/7	The maximum number of allowed simultaneous connections.
protocol_maxgenc onnection <Not support anymore>	<positive integer>	0/7	The maximum general streaming connections . * Not support this parameter anymore when the version number (httpversion) is equal or greater than 0311c.
protocol_rtp_multi cast_scalable	<boolean>	0/7	Indicate whether to support scalable multicast.
protocol_rtp_multi cast_backchannel	<boolean>	0/7	Indicate whether to support backchannel multicast.
protocol_rtp_tcp	<boolean>	0/7	Indicate whether to support RTP over TCP.
protocol_rtp_http	<boolean>	0/7	Indicate whether to support RTP over HTTP.
protocol_spush_mj peg	<boolean>	0/7	Indicate whether to support server push MJPEG.
protocol_snmp	<boolean>	0/7	Indicate whether to support SNMP.
protocol_ipv6	<boolean>	0/7	Indicate whether to support IPv6.
protocol_pppoe	<boolean>	0/7	Indicate whether to support PPPoE.
protocol_ieee8021 x	<boolean>	0/7	Indicate whether to support IEEE802.1x.

NAME	VALUE	SECURITY (get/set)	DESCRIPTION
protocol_qos_cos	<boolean>	0/7	Indicate whether to support CoS.
protocol_qos_dscp	<boolean>	0/7	Indicate whether to support QoS/DSCP.
protocol_ddns	<boolean>	0/7	Indicate whether to support DDNS.
videoin_type	0, 1, 2	0/7	0 => Interlaced CCD 1 => Progressive CCD 2 => CMOS
videoin_nresolution	<positive integer>	0/7	This equals "capability_videoin_c0_nresolution". * This is kept for compatibility.
videoin_resolution	A list of <WxH> <product dependent>	0/7	This equals "capability_videoin_c0_resolution". * This is kept for compatibility.
videoin_maxframerate	A list of <Integer>	0/7	This equals "capability_videoin_c0_maxframerate". * This is kept for compatibility.
videoin_mjpeg_maxframerate	A list of <Integer> and "-"	0/7	This equals "capability_videoin_c0_mjpeg_maxframerate". * This is kept for compatibility.
videoin_h264_maxframerate	A list of <Integer> and "-"	0/7	This equals "capability_videoin_c0_h264_maxframerate". * This is kept for compatibility.
videoin_codec	mjpeg, h264, h265 <product dependent>	0/7	Available codec of a device, split by comma. The sequence is not limited. EX: FD8183 supports H.264 and MJPEG, then this is "mjpeg,h264". IP9171 supports H.264, MJPEG and H.265, then this is "mjpeg,h264,h265"
videoin_streamcod	A list of <Positive	0/7	This equals

NAME	VALUE	SECURITY (get/set)	DESCRIPTION
ec	Integer>		"capability_videoin_c0_streamcodec". * This is kept for compatibility.
videoin_flexiblebitrate	<boolean>	0/7	Indicate whether to support flexible bit rate control.
videoout_codec	A list of the available codec types separated by commas <product dependent>	0/7	Available codec list. "-": not supported
timeshift	<boolean>	0/7	Indicate whether to support time shift caching stream.
audio_aec	<boolean>	0/7	Indicate whether to support acoustic echo cancellation.
audio_aecmode	auto, manual	0/7	Indicate the acoustic echo cancellation control mode. " auto ": control by camera automatically. " manual ": Manually turn on/off the control mode. *Only available when "capability_audio_aec" is "1". * We support this parameter when the version number (httpversion) is equal or greater than 0306b.
audio_aecaffect	-, maxframerate:fixed:1 5 <product dependent>	0/7	When acoustic echo cancellation function is enabled, some features may become malfunction or be forced to a given value. The affected functions are list here. The format is "Affect API name":"Policy":"Description" "Policy" can be categorized into following groups: - (disabled) : UI turns grey and users can't select it. - (unchanged) : UI keeps the status as before and user can't change it.

NAME	VALUE	SECURITY (get/set)	DESCRIPTION
			<ul style="list-style-type: none"> - (hidden) : UI is hidden. - (fixed) : UI is fixed to one selection or value. - (ranged) : UI is fixed to multiple selections or values. - (enabled) : UI is checked. - (notsupport) : the affected function is not available. <p>"Affect API name" can be described in hierarchy, such as "exposurewin.mode.blc:disabled:" which means blc exposure window is disabled. API name can be one word as well, such as "exposurelevel:fixed:6" which means exposurelevel is fixed to level 6. "Description" can be a nonnegative integer or string or NULL. For example: "maxframerate: fixed:15" which means the max frame rate is 15fps when acoustic echo cancellation function is enabled. "- " means no feature is affected. * Only available when "capability_audio_aec" is "1". * We support this parameter when the version number (httpversion) is equal or greater than 0306b.</p>
audio_mic <Not support anymore>	<boolean>	0/7	Indicate whether to support built-in microphone input. * Not support this parameter anymore when the version number (httpversion) is equal or greater than 0301a. * We replace "audio_mic" with

NAME	VALUE	SECURITY (get/set)	DESCRIPTION
			"audio_intmic".
audio_intmic	<0~Positive Integer>	0/7	Internal (Built-in) Microphone. 0: Not support 1: Support Bit 0 for CH0, bit 1 for CH1, and so on.
audio_extmic	<0~Positive Integer>	0/7	External Microphone. 0: Not support 1: Support Bit 0 for CH0, bit 1 for CH1, and so on.
audio_alarm	<0~Positive Integer>	0/7	0: Not support audio alarm. 1: Support audio alarm. Bit 0 for CH0, bit 1 for CH1, and so on.
audio_linein <Not support anymore>	<boolean>	0/7	Indicate whether to support external line input. * Not support this parameter anymore when the version number (httpversion) is equal or greater than 0301a. * It will be replaced by audio_intmic and audio_extmic.
audio_lineout	<boolean>	0/7	Indicate whether to support line output.
audio_michardwar eswitch	<boolean>	0/7	Indicate whether the hardware supports built-in/external mic switch
audio_headphoneo ut <Not support anymore>	<boolean>	0/7	Indicate whether to support headphone output. * Not support this parameter anymore when the version number (httpversion) is equal or greater than 0301a.
audio_audioclip	<boolean>	0/7	Indicate whether to support audio clip function. * We support this parameter when the version number (httpversion) is equal or greater than 0309a.

NAME	VALUE	SECURITY (get/set)	DESCRIPTION
audioin_codec	aac4, gamr, g711, g726, - <product dependent>	0/7	Available audio codec. We take comma to split codec without any space. "aac4": Advanced Audio Coding (AAC) "gamr": Adaptive Multi-Rate (AMR) "g711": G.711 "g726": G.726 "-": Not supported.
audioout_codec	g711, - <product dependent>	0/7	Available codec list for SIP. "-": Not supported.
motion_wintype	rectangle, polygon,-	0/7	The supported motion window type. "polygon": The window is a 2D polygon shape. "rectangle": The window is a 2D rectangle shape. "-": Not supported.
motion_windomain	qvga, px, std, -	0/7	The domain to set an motion window. "qvga": a 320x240 range to represent the whole image. "px": Locate a window in the image with pixels. "std": A normalized 0~9999 range. "-": Not supported.
smartstream_support	<boolean>	0/7	Indicate whether smart stream is supported.
smartstream_version	<integer>	0/7	Number of smart stream version. * Only available when "capability_smartstream_support" is 1
smartstream_nstream	<positive integer>	0/7	Number of stream that support smart stream. * Only available when "capability_smartstream_support" is 1
smartstream_windomain	qvga, px, std, -	0/7	The domain to set an focus window. "qvga": a 320x240 range to represent the whole image. "px": Locate a window in the image

NAME	VALUE	SECURITY (get/set)	DESCRIPTION
			with pixels. "std" : A normalized 0~9999 range. "-" : Not supported. * Only available when "capability_smartstream_support" is 1
smartstream_mode_autotracking	<boolean>	0/7	Indicate whether autotracking smart stream is supported. * Only available when "capability_smartstream_support" is 1
smartstream_mode_manual	<boolean>	0/7	Indicate whether manual smart stream is supported. * Only available when "capability_smartstream_support" is 1
smartstream_mode_hybrid	<boolean>	0/7	Indicate whether hybrid(autotracking+manual) smart stream is supported. * Only available when "capability_smartstream_support" is 1
smartstream_nwindow_autotracking	<positive integer>	0/7	Maximum number of tracking window of autotracking. * Only available when "capability_smartstream_support" is 1
smartstream_nwindow_manual	<positive integer>	0/7	Maximum number of tracking window of manual. * Only available when "capability_smartstream_support" is 1
smartstream_nwindow_hybrid_autotracking	<positive integer>	0/7	Maximum number of tracking window of autotracking in hybrid mode. * Only available when "capability_smartstream_support" is 1
smartstream_nwindow_hybrid_manual	<positive integer>	0/7	Maximum number of tracking window of manual in hybrid mode. * Only available when "capability_smartstream_support" is 1
vadp_supportfeature	<positive integer>	0/7	An 32-bit integer, each bit can be set separately as follows: Bit 0 => VADP interface

NAME	VALUE	SECURITY (get/set)	DESCRIPTION
			Bit 1 => Capture video raw data Bit 2 => Support encode jpeg Bit 3 => Capture audio raw data Bit 4 => Support event trigger Bit 5 => Support license registration Bit 6 => Support shared memory API Bit 7 => Support digital signature of package Bit 8 => Support snapshot
vadp_npackage	<positive integer>	0/7	Indicate the maximum number of VADP package that can be uploaded to the device.
camctrl_httptunnel <Not support anymore>	<boolean>	0/7	Indicate whether to support httptunnel. * Not support this parameter anymore when the version number (httpversion) is equal or greater than 0301b. * It will be replaced by capability_camctrl_ptztunnel.
camctrl_ptztunnel	<boolean>	0/7	Indicate whether to support ptztunnel. * We support this parameter when the version number (httpversion) is equal or greater than 0301b. This equals "capability_camctrl_c0_ptztunnel". * This is kept for compatibility.
camctrl_privilege	<boolean>	0/7	Indicate whether to support "Manage Privilege" of PTZ control in the security page. 1: support both /cgi-bin/camctrl/camctrl.cgi and /cgi-bin/viewer/camctrl.cgi 0: support only /cgi-bin/viewer/camctrl.cgi

NAME	VALUE	SECURITY (get/set)	DESCRIPTION
			This is equivalent to "capability_camctrl_c0_privilege". * This is kept for compatibility.
uart_httptunnel	<boolean>	0/7	Indicate whether to support HTTP tunnel for UART transfer.
transmission_mode	Tx, Rx, Both	0/7	Indicate transmission mode of the machine: TX = server, Rx = receiver box, Both = DVR.
network_wire	<boolean>	0/7	Indicate whether to support Ethernet.
network_wireless	<boolean>	0/7	Indicate whether to support wireless.
network_dualmode	<boolean>	0/7	Indicate whether network dual mode is supported. * Only available when "capability_network_wireless" is "1". * We support this parameter when the version number (httpversion) is equal or greater than 0305a.
wireless_s802dot11b	<boolean>	0/7	Indicate whether to support wireless 802.11b+.
wireless_s802dot11g	<boolean>	0/7	Indicate whether to support wireless 802.11g.
wireless_s802dot11n	<boolean>	0/7	Indicate whether to support wireless 802.11n.
wireless_beginchannel	1 ~ 14	0/7	Indicate the begin channel of wireless network
wireless_endchannel	1 ~ 14	0/7	Indicate the end channel of wireless network
wireless_encrypt_wep	<boolean>	0/7	Indicate whether to support wireless WEP.
wireless_encrypt_wpa	<boolean>	0/7	Indicate whether to support wireless WPA.
wireless_encrypt_wpa2	<boolean>	0/7	Indicate whether to support wireless WPA2.
wireless_apmode_enable	<boolean>	0/7	Indicate whether wireless AP mode is supported.

NAME	VALUE	SECURITY (get/set)	DESCRIPTION
			<p>* Only available when "capability_network_wireless" is "1".</p> <p>* We support this parameter when the version number (httpversion) is equal or greater than 0305a.</p>
wireless_apmode_ ssidprefix	<string>	0/7	<p>Indicate the prefix of broadcasted SSID when camera is in wireless AP mode.</p> <p>* Only available when "capability_wireless_apmode_enable" is "1".</p> <p>* We support this parameter when the version number (httpversion) is equal or greater than 0305a.</p>
derivative_brand	<boolean>	0/7	<p>Indicate whether to support the upgrade function for the derivative brand. For example, if the value is true, the VVTK product can be upgraded to VVXX. (TCVV<->TCXX is excepted)</p>
test_ac	<boolean>	0/7	<p>Indicate whether to support test ac key.</p>
version_onvifdaemon	<string>	0/7	<p>Indicate ONVIF daemon version</p>
version_onviftesttool	<string>	0/7	<p>Indicate ONVIF test tool version</p>
media_totalspace	<positive integer>	0/7	<p>Available memory space (KB) for media.</p>
media_snapshot_maxpreevent	<positive integer>	0/7	<p>Maximum snapshot number before event occurred.</p>
media_snapshot_maxpostevent	<positive integer>	0/7	<p>Maximum snapshot number after event occurred.</p>
media_snapshot_maxsize	<positive integer>	0/7	<p>Maximum size (KB) of a snapshot.</p>
media_videoclip_maxsize	<positive integer>	0/7	<p>Maximum size (KB) of a videoclip.</p>

NAME	VALUE	SECURITY (get/set)	DESCRIPTION
media_videoclip_maxlength	<positive integer>	0/7	Maximum length (second) of a videoclip.
media_videoclip_maxpreevent	<positive integer>	0/7	Maximum duration (second) after event occurred in a videoclip.
image_iris type <Not recommended to use this>	<string>	0/7	<p>Indicate iris type.</p> <ul style="list-style-type: none"> ● "piris": P-Iris ● "dciris": DC-Iris ● "-": No Iris control support <p>* When "capability_iris"=0, this value must be "-".</p> <p>* Note: For some box-type cameras, this value may be varied depending on mounted lens.</p> <p>* We replace "capability_image_iris" with "capability_image_c0_iris".</p> <p>* Reserved for compatibility, and suggest don't use this since [httpversion] > 0301a</p>
image_focusassist <Not recommended to use this>	<boolean>	0/7	<p>Indicate whether to support focus assist.</p> <p>* We replace "capability_image_focusassist" with "capability_image_c0_focusassist".</p> <p>* Reserved for compatibility, and suggest don't use this since [httpversion] > 0301a</p>
localstorage_manageable	<boolean>	0/7	<p>Indicate whether manageable local storage is supported.</p> <p>* Only available when "capability_supportsd" is 1 or "capability_storage_dbenabled" is 1.</p>
localstorage_seamless	0, <positive integer>	0/7	<p>Indicate whether seamless recording is supported.</p> <p>One bit represents one channel.</p> <p>Ex: "3" means channel 0 and channel1</p>

NAME	VALUE	SECURITY (get/set)	DESCRIPTION
			support seamless recording . * Only available when "capability_supportsd" is 1 or "capability_storage_dbenabled" is 1.
localstorage_modnum	0, <positive integer>	0/7	The maximum MOD connection numbers. * Only available when "capability_supportsd" is 1 or "capability_storage_dbenabled" is 1.
localstorage_modversion	<string>	0/7	Indicate MOD daemon version. * Only available when "capability_supportsd" is 1 or "capability_storage_dbenabled" is 1.
localstorage_stormgrversion	<string>	0/7	Indicate storage manager daemon version. * Only available when "capability_supportsd" is 1 or "capability_storage_dbenabled" is 1.
localstorage_supportedge	0, <positive integer>	0/7	An 32-bit integer, which indicates the supportive application of edge storage. If the value of this parameter is larger than 0, it means that the camera supports edge recording function. bit 0 : It supports to record directly to an on-board SD-Card. bit 1~: Currently, they are reserved bit, and the default value is 0. * Only available when "capability_supportsd" is 1 or "capability_storage_dbenabled" is 1.
localstorage_slconnum	0,<positive integer>	0/7	The maximum seamless connection number for each channel. * Only available when "capability_supportsd" is 1 or "capability_storage_dbenabled" is 1.

NAME	VALUE	SECURITY (get/set)	DESCRIPTION
localstorage_smart sd	<boolean>	0/7	The "Lifetime and Log SD Card" feature allows users to obtain the card's remaining lifetime information. 0: Non-support this feature 1: Support this feature * Only Sony SD card can support this function now. * Only available when "capability_supportsd" is 1 or "capability_storage_dbenabled" is 1.
remotecamctrl_ma ster	0, <positive integer>	0/7	Indicate whether to support remote auxiliary camera (master side), this value means supporting max number of auxiliary camera.
remotecamctrl_sla ve	<boolean>	0/7	Indicate whether to support remote camera control (slave side).
fisheyelocaldewarp _c<0~(capability_n videoin)-1> <product dependent>	0, <positive integer>	0/7	Indicate the supported streams of local dewarp. One bit represents one supported stream. The LSB indicates stream 0. Ex: "3" means stream 0 and stream 1 support local dewarp. * Only available when "capability_fisheye" > 0
shockalarm_suppo rt	<boolean>	0/7	Indicate whether to support the shock detection. * We support this parameter when the version number (httpversion) is equal or greater than 0306e.
layout_redirection	<string>	0/7	Indicate which function will be redirected to the vadv package path. "-": Not supported. * We support this parameter when the version number (httpversion) is equal or greater than 0309a.

Group: **capability_camctrl_c<0~(n-1)>** n denotes the value of "capability_nvideoin"
(capability_ptzenabled > 0)

* We support this group when the version number (httpversion) is equal or greater than 0303b.

PARAMETER	VALUE	SECURITY (get/set)	DESCRIPTION
ptztunnel	<boolean>	0/7	Indicate whether to support ptztunnel in this video input.
privilege	<boolean>	0/7	Indicate whether to support "Manage Privilege" of PTZ control in the security page in this video input. 1: support both /cgi-bin/camctrl/camctrl.cgi and /cgi-bin/viewer/camctrl.cgi 0: support only /cgi-bin/viewer/camctrl.cgi
rs485	<boolean>	0/7	An 32-bit integer, each bit can be set separately as follows: Bit 0 => support rs485-in Bit 1 => support rs485-out
buildinpt	<boolean>	0/7	An 32-bit integer, each bit can be set separately as follows: Bit 0 => support build-in pan Bit 1 => support build-in tilt
zoommodule	<boolean>	0/7	Indicate whether to support zoom lens. In our product, only SD series and IZ series use the zoom lens. * Both varifocal and zoom lenses are built with movable elements that permit changing the effective focal length. And the key difference between a varifocal and a zoom lens can be explained by thinking about a lens that has been focused on an object at any focal length. A varifocal will need to be refocused whenever the focal length is adjusted; the zoom will stay in focus when the focal length is adjusted.

PARAMETER	VALUE	SECURITY (get/set)	DESCRIPTION
focusmode	auto,onetimeauto,spotlight,manual <product dependent>	0/7	Focus mode selection: "auto" : Camera will automatically adjust the focus position full time to adapt a clear picture. "onetimeauto" : Camera will automatically adjust the focus position one time, which follows any PTZ control. "spotlight" : Camera will automatically adjust the focus position full time, and to consider a spotlight avoidance situation. "manual" : Turn off the automatically focus function. For user to control the focus position manually as their purpose. * Only available when "capability_camctrl_c<0~(n-1)>_zoommodule" is 1. * We support this parameter when the version number (httpversion) is equal or greater than 0304a.

Group: **capability_ptz_c<0~(n-1)>** n denotes the value of "capability_nvideoin" (capability_ptzenabled > 0 and capability_camctrl_c<0~(n-1)>_zoommodule !=0)

* We support this group when the version number (httpversion) is equal or greater than 0303b.

PARAMETER	VALUE	SECURITY (get/set)	DESCRIPTION
panspeedlv	0, <positive integer>	0/7	The maximum speed level of pan motion. *Only available when bit0 of "capability_camctrl_c<0~(n-1)>_buildinpt" is "1"

PARAMETER	VALUE	SECURITY (get/set)	DESCRIPTION
minpan	0, <positive integer>	0/7	The lower limit for pan position. *Only available when bit0 of "capability_camctrl_c<0~(n-1)>_buildin pt" is "1"
maxpan	0, <positive integer>	0/7	The upper limit for pan position. *Only available when bit0 of "capability_camctrl_c<0~(n-1)>_buildin pt" is "1"
minpanangle	<integer>	0/7	The lower limit for pan angle. *Only available when bit0 of "capability_camctrl_c<0~(n-1)>_buildin pt" is "1"
maxpanangle	<integer>	0/7	The upper limit for pan angle. *Only available when bit0 of "capability_camctrl_c<0~(n-1)>_buildin pt" is "1"
tiltspeedlv	0, <positive integer>	0/7	The maximum speed level of tilt motion. *Only available when bit1 of "capability_camctrl_c<0~(n-1)>_buildin pt" is "1"
mintilt	0, <positive integer>	0/7	The lower limit for tilt position. *Only available when bit1 of "capability_camctrl_c<0~(n-1)>_buildin pt" is "1"
maxtilt	0, <positive integer>	0/7	The upper limit for tilt position. *Only available when bit1 of "capability_camctrl_c<0~(n-1)>_buildin pt" is "1"
mintiltangle	<integer>	0/7	The lower limit for tilt angle. *Only available when bit1 of "capability_camctrl_c<0~(n-1)>_buildin pt" is "1"

PARAMETER	VALUE	SECURITY (get/set)	DESCRIPTION
maxtiltangle	<integer>	0/7	The upper limit for tilt angle. *Only available when bit1 of "capability_camctrl_c<0~(n-1)>_buildinpt" is "1"
zoomspeedlv	0, <positive integer>	0/7	The maximum speed level of zoom motion. *Only available when the value of "capability_camctrl_c<0~(n-1)>_zoommodule" is "1"
minzoom	0, <positive integer>	0/7	The lower limit for zoom position. *Only available when the value of "capability_camctrl_c<0~(n-1)>_zoommodule" is "1"
maxzoom	0, <positive integer>	0/7	The upper limit for zoom position. *Only available when the value of "capability_camctrl_c<0~(n-1)>_zoommodule" is "1"
maxdzoom	0, <positive integer>	0/7	The upper limit for digital zoom position. *Only available when the value of "capability_camctrl_c<0~(n-1)>_zoommodule" is "1"
focusspeedlv	0, <positive integer>	0/7	The maximum speed level of focus motion. *Only available when the value of "capability_camctrl_c<0~(n-1)>_zoommodule" is "1"
minfocus	0, <positive integer>	0/7	The lower limit for focus position. *Only available when the value of "capability_camctrl_c<0~(n-1)>_zoommodule" is "1"
maxfocus	0, <positive integer>	0/7	The upper limit for focus position. *Only available when the value of "capability_camctrl_c<0~(n-1)>_zoommodule" is "1"

Group: **capability_daynight_c<0~(n-1)>** n denotes the value of "capability_nvideoin"

PARAMETER	VALUE	SECURITY (get/set)	DESCRIPTION
support	<boolean>	0/7	Indicate whether the camera supports day/night mode switch
builtinir	<boolean>	0/7	Indicate whether to support built-in IR led.
builtinwled	<boolean>	0/7	Indicate whether to support built-in white led.
externalir	<boolean>	0/7	Indicate whether to support external IR led.
optimizedir	<boolean>	0/7	Indicate whether to support optimized IR control technology.
smartir	<boolean>	0/7	Indicate whether to support smart IR.
ircutfilter	<boolean>	0/7	Indicate whether to support IR cut.
lightsensor	<boolean>	0/7	Indicate whether to support light sensor.
blackwhitemode	<boolean>	0/7	Indicate whether to support automatically switch to Black & White display during the night mode. * We support this parameter when the version number (httpversion) is equal or greater than 0302a.

PARAMETER	VALUE	SECURITY (get/set)	DESCRIPTION
ircutsensitivity_type	<string>	0/7	Indicate the cgi interface of "ircutcontrol_sensitivity". "options" : the value of "ircutcontrol_sensitivity" parameter is "low, normal,high". "normalize" : the value of "ircutcontrol_sensitivity" parameter is "1~100" "-":not support * Only available when "capability_daynight_c<0~(n-1)>_support" is 1. * We support this parameter when the version number (httpversion) is equal or greater than 0302a.
ircutsensitivity_supportlevel	0, <positive integer>	0/7	The value indicate the support strength level of ircutsensitivity. * Only available when "capability_daynight_c<0~(n-1)>_support" is 1 and "capability_daynight_c<0~(n-1)>_ircutsensitivity_type" is not "-". * We support this parameter when the version number (httpversion) is equal or greater than 0302a.
extled_interface	do <product dependent>	0/7	The device interface of external IR led: "do": digital output * Only available when "capability_daynight_c<0~(n-1)>_externalir" is 1

PARAMETER	VALUE	SECURITY (get/set)	DESCRIPTION
spectrum_support	<boolean>	0/7	Indicate whether to support proposed a brightness enhancement method based on CCM(Color Correction Matrix) model to improve the brightness effect of the images if the IR and blue light exists. * Only available when "capability_daynight_c<0~(n-1)>_support" is 1
spectrum_mode	visible,ir,irenhanced,blueenhanced <product dependent>	0/7	Indicate the spectrum mode. "visible": The ideal default setting for visible light. "ir": The ideal default setting for IR light. "irenhanced": This CCM model increases the brightness effect of IR light. "blueenhanced": This CCM model increases the brightness effect of blue light. *Only available when "capability_daynight_c<0~(n-1)>_support" is 1 and "capability_daynight_c<0~(n-1)>_spectrum_support" is 1

PARAMETER	VALUE	SECURITY (get/set)	DESCRIPTION
mode	auto,daynight,di,di2, di3,di4,schedule,- <product dependent>	0/7	<p>Indicate the day / night switch mode.</p> <p>"auto": The Camera automatically judges the current operation mode by the level of ambient light detected.</p> <p>"daynight": support day mode and night mode. In day mode, the camera streams color video. In night mode, the camera streams black and white video in low light environments.</p> <p>"di": the camera automatically switches the current mode when a ditigal input 1 is triggered.</p> <p>"di2": the camera automatically switches the current mode when a ditigal input 2 is triggered.</p> <p>"di3": the camera automatically switches the current mode when a ditigal input 3 is triggered.</p> <p>"di4": the camera automatically switches the current mode when a ditigal input 4 is triggered.</p> <p>"schedule": The Camera switches between day mode and night mode based on a specified schedule.</p> <p>"-": not support</p> <p>* We support this parameter when the version number (httpversion) is equal or greater than 0309d.</p>

Group: **capability_videoin_c<0~(n-1)>** n denotes the value of "capability_nvideoin"

PARAMETER	VALUE	SECURITY (get/set)	DESCRIPTION
lens_type	fisheye, fixed, varifocal, changeable, motor, ics,- <product dependent>	0/7	The lens type of this channel. "fisheye" : Fisheye lens "fixed" : Build-in fixed-focus lens. "varifocal" : Build-in varifocal lens. "changeable" : changeable lens. Like box-type camera, users can install any C-Mount or CS-Mount lens as they wish. "motor" : Lens with motor to support zoom, focus, etc. "ics" : An i-CS lens is an intelligent CS-mount lens that contains information about, among other things, its own geometrical distortion and the exact position of its zoom, focus, and iris opening. "-" : N/A * Only available when [httpversion] >= 0301a
color_support	<boolean>	0/7	1 : camera can select to display color or black/white video streams. 0: camera do not support this feature. * We support this parameter when the version number (httpversion) is equal or greater than 0310a.
eptz_zoomratio	<string>	0/7	Indicate the support zoom ratio of eptz. "-" : not support ePTZ * We support this parameter when the version number (httpversion) is equal or greater than 0310a.
rotation	<boolean>	0/7	Indicate current mode whether support video rotation

PARAMETER	VALUE	SECURITY (get/set)	DESCRIPTION
rotationaffect	- <product dependent>	0/7	<p>When rotation is enabled, some features may become malfunction or be forced to a given value. The affected functions are list here.</p> <p>The format is "Affect API name":"Policy":"Description"</p> <p>"Policy" can be categorized into following groups:</p> <ul style="list-style-type: none"> - (disabled) : UI turns grey and users can't select it. - (unchanged) : UI keeps the status as before and user can't change it. - (hidden) : UI is hidden. - (fixed) : UI is fixed to one selection or value. - (ranged) : UI is fixed to multiple selections or values. - (enabled) : UI is checked. - (notsupport) : the affected function is not available. <p>"Affect API name" can be described in hierarchy, such as "exposurewin.mode.blc:disabled:" which means blc exposure window is disabled. API name can be one word as well, such as "exposurelevel:fixed:6" which means exposurelevel is fixed to level 6.</p> <p>"Description" can be a nonnegative integer or string or NULL.</p> <p>"-" means no feature is affected.</p> <p>* When "rotation"=0, this value must be "-"</p> <p>* We support this parameter when the version number (httpversion) is equal or greater than 0304b.</p>

PARAMETER	VALUE	SECURITY (get/set)	DESCRIPTION
rotationangle	<string>	0/7	The different angles which camera supports for rotation. * Only available when "capability_videoin_c<0~(n-1)>_rotation" is 1. * We support this parameter when the version number (httpversion) is equal or greater than 0309b.
orientation	flip,mirror,rotation <product dependent>	0/7	Indicates the camera supports flip, mirror or rotation. * We support this parameter when the version number (httpversion) is equal or greater than 0309b.
streamcodec	<positive integer>	0/7	Represent supported codec types of each stream. This contains a list of positive integers, split by comma. Each one stands for a stream, and the definition is as following: Bit 0: Support MPEG4. Bit 1: Support MJPEG Bit 2: Support H.264 Bit 3: Support H.265
mode	0,<positive integer>	0/7	Indicate current video mode.
nmode	<positive integer>	0/7	Indicate how many video modes supported by this channel.
maxsize	<WxH>	0/7	The maximum resolution of all modes in this channel, the unit is pixel.
nprivacymask	0, <positive integer>	0/7	Number of privacy mask per channel
nresolution	<positive integer>	0/7	The maximum resolution options (listed in "resolution") in current video mode.

PARAMETER	VALUE	SECURITY (get/set)	DESCRIPTION
resolution	A list of <WxH> <product dependent>	0/7	Resolution options in current video mode. These options are the possible options for "videoin_c<n>_s<m>_resolution". The last one is the maximum resolution in current mode.
maxresolution	A list of <Integer>	0/7	Represent supported maximum resolution of each stream in current video mode. * The element number is defined as "capability_nmediastream".
minresolution	A list of <Integer>	0/7	Represent supported minimum resolution of each stream in current video mode. * The element number is defined as "capability_nmediastream". * We support this parameter when the version number (httpversion) is equal or greater than 0304b.
maxframerate	A list of <Integer>	0/7	Indicate frame rate that the video source outputs in current video mode. One to one mapping to the resolution in "resolution". * The element number is defined as "nresolution" in this group. * This parameter may be changed when "videoin_c<n>_cmosfreq"=50 or "videoin_c<n>_modulation"=pal. Ex: 30 fps is changed to 25 fps, 60 fps is changed to 50 fps, and so on.

PARAMETER	VALUE	SECURITY (get/set)	DESCRIPTION
mjpeg_maxframerate	A list of <Positive Integer> and "-"	0/7	<p>Maximum fps that the device can encoded with MJPEG on resolutions in current video mode.</p> <p>"-" means not support.</p> <p>* One to one mapping to the resolution in "resolution".</p> <p>* The element number is defined as "nresolution" in this group.</p> <p>* This parameter may be changed when "videoin_c<n>_cmosfreq"=50 or "videoin_c<n>_modulation"=pal.</p> <p>Ex: 30 fps is changed to 25 fps, 60 fps is changed to 50 fps, and so on.</p> <p>* Only available when 'mjpeg' is listed in "capability_videoin_codec".</p>
mjpeg_maxbitrate	<positive integer>, -	0/7	<p>Maximum bitrates of MJPEG.</p> <p>The unit is bps.</p> <p>"-" means MJPEG does not support bit rate control.</p> <p>* Only available when 'mjpeg' is listed in "capability_videoin_codec".</p>
h264_maxframerate	A list of <Positive Integer> and "-"	0/7	<p>Maximum fps that the device can encoded with H.264 on resolutions in current video mode.</p> <p>"-" means not support.</p> <p>* One to one mapping to the resolution in "resolution".</p> <p>* The element number is defined as "nresolution" in this group.</p> <p>* This parameter may be changed when "videoin_c<n>_cmosfreq"=50 or "videoin_c<n>_modulation"=pal.</p> <p>Ex: 30 fps is changed to 25 fps, 60 fps is changed to 50 fps, and so on.</p> <p>* Only available when 'h264' is listed in "capability_videoin_codec".</p>

PARAMETER	VALUE	SECURITY (get/set)	DESCRIPTION
h264_maxbitrate	<positive integer>	0/7	Maximum bitrates of H.264. The unit is bps. * Only available when 'h264' is listed in "capability_videoin_codec".
h264_profile	baseline,main,high	0/7	Indicate H264 profiles * Only available when 'h264' is listed in "capability_videoin_codec". * We support this parameter when the version number (httpversion) is equal or greater than 0309a.
h265_maxframerate	A list of <Positive Integer> and "-"	0/7	Maximum fps that the device can encoded with H.265 on resolutions in current video mode. "-" means not support. * One to one mapping to the resolution in "resolution". * The element number is defined as "nresolution" in this group. * This parameter may be changed when "videoin_c<n>_cmosfreq"=50 or "videoin_c<n>_modulation"=pal. Ex: 30 fps is changed to 25 fps, 60 fps is changed to 50 fps, and so on. * Only available when 'h265' is listed in "capability_videoin_codec".
h265_maxbitrate	<positive integer>	0/7	Maximum bitrates of H.265. The unit is bps. * Only available when 'h265' is listed in "capability_videoin_codec".
h265_profile	main,main10 <product dependent>	0/7	Indicate H265 profiles * Only available when 'h265' is listed in "capability_videoin_codec". * We support this parameter when the version number (httpversion) is equal or greater than 0309a.

PARAMETER	VALUE	SECURITY (get/set)	DESCRIPTION
fisheye_mounttype <Not recommended to use this>	ceiling, wall, floor <product dependent>	0/7	Indicate the supported type. wall mount: 180° panoramic view ceiling mount: 360° surround view without blind spots floor mount: 360° surround view without blind spots * Only available when "capability_fisheye" > 0 * It's recommended to use "capability_videoin_c<0~(n-1)>_mounttype"
mounttype	ceiling, wall, floor,- <product dependent * Available values are listed in "capability_videoin_c<0~(n-1)>_mounttype "	0/7	Indicate the supported mount type. "-": not support * We support this parameter when the version number (httpversion) is equal or greater than 0309c.
dintraperiod_support	<boolean>	0/7	0: Non-support "Dynamic intra frame period" 1: Support "Dynamic intra frame period" "Dynamic intra frame period" can be used to reduce bitrate by reducing the number of I-frame. * We support this parameter when the version number (httpversion) is equal or greater than 0301c.

PARAMETER	VALUE	SECURITY (get/set)	DESCRIPTION
cameraunit_name	CU8131, CU8171, CU8161-H, CU8162-H, CU8163-H, CU8361-H, ..., - <product dependent>	0/7	A "camera unit" name of a split-type camera system, which the camera unit and the video core are separated. -: If the camera is not a split-type camera system, the value of this parameter is "-". * We support this parameter when the version number (httpversion) is equal or greater than 0302b.
cmosfreq_support	<boolean>	0/7	0: The power line frequency(50/60Hz) is detected by camera automatically. 1: The power line frequency(50/60Hz) can be set by user. * We support this parameter when the version number (httpversion) is equal or greater than 0308a.
smartfps_support	<boolean>	0/7	Indicate whether to support Smart fps function. * We support this parameter when the version number (httpversion) is equal or greater than 0309a.
smartq_support	<boolean>	0/7	Indicate whether to support Smart Q function. * We support this parameter when the version number (httpversion) is equal or greater than 0309a.

Group: **capability_videoin_c<0~(n-1)>_localdewarp**

(**capability_fisheycallocaldewarp_c<0~(capability_nvideoin)-1> > 0**)

n denotes the value of "capability_nvideoin"

PARAMETER	VALUE	SECURITY (get/set)	DESCRIPTION
typeceilingmount	1O, 1P, 2P, 1R, 4R	0/7	Available dewarp types of ceiling and floor mount.
typewallmount	1O, 1P, 1R, 4R	0/7	Available dewarp types of wall mount.

PARAMETER	VALUE	SECURITY (get/set)	DESCRIPTION
resolutionC1P	A list of <WxH>	0/7	Available resolutions of 1P mode of ceiling and floor mount.
resolutionC2P	A list of <WxH>	0/7	Available resolutions of 2P mode of ceiling and floor mount.
resolutionC1R	A list of <WxH>	0/7	Available resolutions of 1R mode of ceiling and floor mount.
resolutionC4R	A list of <WxH>	0/7	Available resolutions of 4R mode of ceiling and floor mount.
resolutionW1P	A list of <WxH>	0/7	Available resolutions of 1P mode of wall mount.
resolutionW1R	A list of <WxH>	0/7	Available resolutions of 1R mode of wall mount.
resolutionW4R	A list of <WxH>	0/7	Available resolutions of 4R mode of wall mount.

Group: **capability_videoin_c<0~(n-1)>_mode<0~(m-1)>** n denotes the value of "capability_nvideoin", m denotes the value of "capability_videoin_c<0~(n-1)>_nmode"

PARAMETER	VALUE	SECURITY (get/set)	DESCRIPTION
rotation	<boolean>	0/7	Indicate this mode whether support video rotation

PARAMETER	VALUE	SECURITY (get/set)	DESCRIPTION
eptz	0, <positive integer>	0/7	<p>Indicate this mode whether support eptz.</p> <p>For "nvideoin" = 1, the definition is as following: A 32-bits integer, each bit can be set separately as follows: Bit 0 => 1st stream supports ePTZ or not. Bit 1 => 2nd stream supports ePTZ or not, and so on.</p> <p>For nvideoin >= 2, the definition is different: First all 32 bits are divided into groups for channel. Ex: nvideoin = 2, bit 0~15 are the 1st group for 1st channel, bit 16~31 are the 2nd group for 2nd channel. nvideoin = 3, bit 0~9 are the 1st group for 1st channel, bit 10~19 are the 2nd group for 2nd channel, bit 20~31 are the 3rd group for 3rd channel.</p> <p>Then, the 1st bit of the group indicates 1st stream of a channel support ePTZ or not. The 2nd bit of the group indicates 2nd stream of a channel support ePTZ or not, and so on.</p> <p>* We support this parameter when the version number (httpversion) is equal or greater than 0304b.</p>
wdrpro	0, 1, 2	0/7	<p>Indicate this mode whether support WDR pro.</p> <p>0: Non-support WDR Pro 1: Support WDR Pro 2: Support WDR Pro and WDR Pro II</p> <p>* We support this parameter when the version number (httpversion) is equal or greater than 0304b.</p>
effectivepixel	<WxH>	0/7	<p>The visible area of full scene in this video mode.</p> <p>The unit is pixel in source.</p> <p>* If "effectivepixel"<"capability_videoin_c<0~(n-1)>_maxsize", then the visible area is located at the center of full scene.</p>

PARAMETER	VALUE	SECURITY (get/set)	DESCRIPTION
outputsize	<WxH>	0/7	<p>The output size of source, equal to the captured size by device, in this video mode. The unit is pixel.</p> <p>This value is used as a basic coordinate system for many features, like ePTZ, privacy mask, motion, etc.</p> <p>* Source (most for image sensor) may perform scale or binning, etc on image data, and output data with smaller size. This parameter is designed to represent this.</p>
binning	0, 1, 3	0/7	<p>Indicate binning is used or not in this video mode.</p> <p>0: No binning 1: 2x2 binning 3: 3x3 binning</p> <p>* Binning is a technology to increase light sensitivity by combining multiple pixels to one. The drawback is reduced resolution. We design this parameter to disclose this information.</p>
nresolution	<positive integer>	0/7	How many resolution options in this video mode.
resolution	A list of <WxH>	0/7	<p>Resolution options in this video mode. The last one is the maximum resolution in this video mode.</p> <p>* The element number is defined as "nresolution" in this group.</p>
maxresolution	A list of <Integer>	0/7	<p>Represent supported maximum resolution of each stream in current video mode.</p> <p>* The element number is defined as "capability_nmediastream".</p>

PARAMETER	VALUE	SECURITY (get/set)	DESCRIPTION
minresolution	A list of <Integer>	0/7	<p>Represent supported minimum resolution of each stream in current video mode.</p> <ul style="list-style-type: none"> * The element number is defined as "capability_nmediastream". * We support this parameter when the version number (httpversion) is equal or greater than 0304b.
maxframerate	A list of <Positive Integer>	0/7	<p>Indicates frame rate that the video source outputs in this video mode.</p> <ul style="list-style-type: none"> * One to one mapping to the resolution in "resolution". * The element number is defined as "nresolution" in this group. * This parameter records the frame rate when "videoin_c<0~(n-1)>_cmosfreq"=60 or "videoin_c<0~(n-1)>_modulation"=ntsc
maxfps_mjpeg	A list of <Positive Integer> and "-"	0/7	<p>Maximum fps which the device can encoded with MJPEG on resolutions in this video mode.</p> <p>"-" means not support.</p> <ul style="list-style-type: none"> * One to one mapping to the resolution in "resolution". * The element number is defined as "nresolution" in this group. * This parameter records the frame rate when "videoin_c<0~(n-1)>_cmosfreq"=60 or "videoin_c<0~(n-1)>_modulation"=ntsc * Only available when 'mjpeg' is listed in "capability_videoin_codec".

PARAMETER	VALUE	SECURITY (get/set)	DESCRIPTION
maxfps_h264	A list of <Positive Integer> and "-"	0/7	Maximum fps which the device can encoded with H.264 on resolutions in this video mode. "-" means not support. * One to one mapping to the resolution in "resolution". * The element number is defined as "nresolution" in this group. * This parameter records the frame rate when "videoin_c<0~(n-1)>_cmosfreq"=60 or "videoin_c<0~(n-1)>_modulation"=ntsc * Only available when 'h264' is listed in "capability_videoin_codec".
maxfps_h265	A list of <Positive Integer> and "-"	0/7	Maximum fps which the device can encoded with H.265 on resolutions in this video mode. "-" means not support. * One to one mapping to the resolution in "resolution". * The element number is defined as "nresolution" in this group. * This parameter records the frame rate when "videoin_c<0~(n-1)>_cmosfreq"=60 or "videoin_c<0~(n-1)>_modulation"=ntsc * Only available when 'h265' is listed in "capability_videoin_codec".
description	<string[128]>	0/7	Description about this mode.

Group: **capability_image_c<0~(n-1)>** n denotes the value of "capability_nvideoin"

NAME	VALUE	SECURITY (get/set)	DESCRIPTION
basicsetting	0, <positive integer>	0/7	A 32-bits integer, each bit can be set separately as follows: Bit 0 => Supports Brightness or not.

NAME	VALUE	SECURITY (get/set)	DESCRIPTION
			<p>Bit 1 => Supports Contrast or not.</p> <p>Bit 2 => Supports Saturation or not.</p> <p>Bit 3 => Supports Sharpness or not.</p> <p>Bit 4 => Supports adjusting the image to proper position horizontally or not.</p> <p>Bit 5 => Supports adjusting the image to proper position vertically or not.</p>
hlm	<boolean>	0/7	<p>Hightlight Mask: The function will strengthen the image contrast and mask the specified zone of image if any strong spot-light exists.</p> <p>* We support this parameter when the version number (httpversion) is equal or greater than 0311a.</p>
wdrpro_mode	0, 1, 2	0/7	<p>0: Non-support WDR Pro</p> <p>1: Support WDR Pro</p> <p>2: Support WDR Pro and WDR Pro II</p>
wdrpro_strength	0, 1	0/7	<p>0: Non-support tuning strength of WDR Pro</p> <p>1: Support tuning strength of WDR Pro</p> <p>* If "capability_image_c<0~(n-1)>_wdrpro"=1, this may be either 0 or 1.</p>
wdrpro_supportlevel	0, <positive integer>	0/7	<p>This contains a list of positive integers, split by comma.</p> <p>If "wdrpro_mode" =1, then the value indicate the support strength level of WDR Pro.</p> <p>If "wdrpro_mode" =2, then the first number indicate the support strength level of WDR Pro, and the ssecond number indicate the support strength level of WDR Pro II.</p>
wdrpro_affect	-, exposurewin.mode :fixed:auto,	0/7	<p>When WDR Pro is enabled, some features may become malfunction or be forced to a given value. The</p>

NAME	VALUE	SECURITY (get/set)	DESCRIPTION
	exposurewin.mode .blc:disabled:, aespeed:disabled:, exposurelevel:hid den:, exposurelevel:fixed :<x>, exposurelevel:fixed :<x>/<x>, exposurelevel:rang ed:<x>-<x>, exposuremode:fixe d:auto <x>: nonnegative integer <product dependent>		affected functions are list here. The format is "Affect API name":"Policy":"Description" "Policy" can be categorized into following groups: - (disabled) : UI turns grey and users can't select it. - (unchanged) : UI keeps the status as before and user can't change it. - (hidden) : UI is hidden. - (fixed) : UI is fixed to one selection or value. - (ranged) : UI is fixed to multiple selections or values. - (enabled) : UI is checked. - (notsupport) : the affected function is not available. "Affect API name" can be described in hierarchy, such as "exposurewin.mode.blc:disabled:" which means blc exposure window is disabled. API name can be one word as well, such as "exposurelevel:fixed:6" which means exposurelevel is fixed to level 6. "Description" can be a nonnegative integer or string or NULL. For example: "exposurelevel:fixed:6/8/12" which means exposurelevel is fixed to level 6, level 8 and level 12. "-" means no feature is affected. * When "wdrpro"=0, this value must be "-"
wdrpro_description	<string>	0/7	Description about WDR Pro mode. * Only available when

NAME	VALUE	SECURITY (get/set)	DESCRIPTION
			"capability_image_c<0~(n-1)>_wdrpro_mode" > 0
wdrc_mode	0, 1	0/7	0: Non-support WDR Enhanced 1: Support WDR Enhanced
wdrc_supportlevel	0, <positive integer>	0/7	Indicate the support strength level of WDR Enhanced.
wdrc_affect	-, exposurewin.mode: fixed:auto, exposurewin.mode: .blc:disabled:, aespeed:disabled:, exposurelevel:hid den:, exposurelevel:fixed :<x>, exposurelevel:fixed :<x>/<x>, exposurelevel:rang ed:<x>-<x>, exposuremode:fixe d:auto <x>: nonnegative integer <product dependent>	0/7	When WDR Enhanced is enabled, some features may become malfunction or be forced to a given value. The affected functions are list here. The format is "Affect API name":"Policy":"Description" "Policy" can be categorized into following groups: - (disabled) : UI turns grey and users can't select it. - (unchanged) : UI keeps the status as before and user can't change it. - (hidden) : UI is hidden. - (fixed) : UI is fixed to one selection or value. - (ranged) : UI is fixed to multiple selections or values. - (enabled) : UI is checked. - (notsupport) : the affected function is not available. "Affect API name" can be described in hierarchy, such as "exposurewin.mode.blc:disabled:" which means blc exposure window is disabled. API name can be one word as well, such as "exposurelevel:fixed:6" which means exposurelevel is fixed to level 6. "Description" can be a nonnegative

NAME	VALUE	SECURITY (get/set)	DESCRIPTION
			integer or string or NULL. For example: "exposurelevel:fixed:6/8/12" which means exposurelevel is fixed to level 6, level 8 and level 12. "- " means no feature is affected. * When "wdrc"=0, this value must be "- "
dnr	0,1	0/7	0: Non-support 3D digital noise reduction 1: Support 3D digital noise reduction
dnrstrength	<positive integer>	0/7	Indicate the support strength level of 3D digital noise reduction. * Only available when "capability_image_c<0~(n-1)>_dnr" > 0. * We support this parameter when the version number (httpversion) is equal or greater than 0306d.
dnrtype	2d,3d	0/7	Description about DNR type. * Only available when "capability_image_c<0~(n-1)>_dnr" > 0. * We support this parameter when the version number (httpversion) is equal or greater than 0308a.
eis	0,1	0/7	0: Non-support electronic image stabilizer 1: Support electronic image stabilizer
is_mode	eis, dis, -	0/7	Indicate the image stabilizer mode. "eis": electronic image stabilizer "dis": digital image stabilizer "-": not support * We support this parameter when the version number (httpversion) is equal or greater than 0302a.

NAME	VALUE	SECURITY (get/set)	DESCRIPTION
is_strength	<boolean>	0/7	0: Non-support tuning strength of image stabilizer mode. 1: Support tuning strength of image stabilizer mode. * Only available when "capability_image_c<0~(n-1)>_is_mode" is not "-". * We support this parameter when the version number (httpversion) is equal or greater than 0302a.
is_supportlevel	0, <positive integer>	0/7	Indicate the support strength level of image stabilizer mode. * Only available when "capability_image_c<0~(n-1)>_is_mode" is not "-". * We support this parameter when the version number (httpversion) is equal or greater than 0302a.
is_affect	-, minexposure:hide n;, mingain:hidden;, wdrpro:unchanged ;, 3dnr:unchanged;, or others <x>: nonnegative integer <product dependent>	0/7	When Is mode is not "-", some features may become malfunction or be forced to a given value. The affected functions are list here. The format is "Affect API name":"Policy":"Description" "Policy" can be categorized into following groups: - (disabled) : UI turns grey and users can't select it. - (unchanged) : UI keeps the status as before and user can't change it. - (hidden) : UI is hidden. - (fixed) : UI is fixed to one selection or value. - (ranged) : UI is fixed to multiple selections or values.

NAME	VALUE	SECURITY (get/set)	DESCRIPTION
			<p>- (enabled) : UI is checked.</p> <p>- (notsupport) : the affected function is not available.</p> <p>"Affect API name" can be described in hierarchy, such as "exposurewin.mode.blc: disabled:" which means blc exposure window is disabled. API name can be one word as well, such as "exposurelevel:fixed:6" which means exposurelevel is fixed to level 6.</p> <p>"Description" can be a nonnegative integer or string or NULL.</p> <p>"-" means no feature is affected.</p> <p>* Only available when "capability_image_c<0~(n-1)>_is_mode" is not "-".</p> <p>* We support this parameter when the version number (httpversion) is equal or greater than 0302a.</p>
scenemode_support	0,1	0/7	<p>0: Non-support scene mode</p> <p>1: Support scene mode</p>
scenemode_supporttype	visibility, noiseless, <product dependent> lpcparkinglot, lpcstreet, lpchighway, auto, deblur, lpcfreesway <product dependent>	0/7	<p>list all the scene mode which are supported in the camera.</p> <p>* Only available when "capability_image_c<0~(n-1)>_scenemode_support" is 1</p>
wbmode	auto, panorama, manual, rbgain,	0/7	<p>Available white balance mode.</p> <p>"-" means white balance is not supported.</p>

NAME	VALUE	SECURITY (get/set)	DESCRIPTION
	widerange, outdoor,indoor, sodiumauto, - <product dependent>		
iristype	piris, dciris, -	0/7	Indicate iris type. "piris": P-Iris "dciris": DC-Iris "-": No Iris control support * Note: For some cameras, this value may be varied depending on mounted lens.
sensortype	rawsensor, smartsensor, thermalsensor, -	0/7	Indicate sensor type. " rawsensor ": Raw sensor " smartsensor ": Smart sensor " thermalsensor ": Thermal sensor "-": N/A * We support this parameter when the version number (httpversion) is equal or greater than 0302a.
exposure_mode	0,1	0/7	0: Non-support exposure control. 1: Support exposure control.
exposure_modetype	auto, shutterpriority, irispriority, manual <product dependent>	0/7	Available mode of exposure setting. * Only available when "capability_image_c<0~(n-1)>_exposure_mode" is 1. * We support this parameter when the version number (httpversion) is equal or greater than 0302a.
exposure_rangetype	onevalue, twovalues	0/7	Support interface of exposure range. " onevalue ": The parameter is a constant value. " twovalues ": Need two parameters to indicate the exposure range. * Only available when

NAME	VALUE	SECURITY (get/set)	DESCRIPTION
			"capability_image_c<0~(n-1)>_exposure_mode" is 1. * We support this parameter when the version number (httpversion) is equal or greater than 0302a.
exposure_shuttervalue etype	fixed, maximum, -	0/7	* One to one mapping to the mode type in "exposure_modetype". "fixed" : The shutter value is the assigned value (videoin_c<0~(n-1)>_shuttervalue). "maximum" : The shutter value can be up to the assigned value (videoin_c<0~(n-1)>_shuttervalue). "-": not support. * Only available when "capability_image_c<0~(n-1)>_exposure_mode" is 1 and "capability_image_c<0~(n-1)>_exposure_rangetype" is "onevalue". * We support this parameter when the version number (httpversion) is equal or greater than 0302a.
exposure_gainvalue type	fixed, maximum, -	0/7	* One to one mapping to the mode type in "exposure_modetype". "fixed" : The shutter value is the assigned value (videoin_c<0~(n-1)>_gainvalue). "maximum" : The shutter value can be up to the assigned value (videoin_c<0~(n-1)>_gainvalue). "-": not support. * Only available when "capability_image_c<0~(n-1)>_exposure_mode" is 1 and "capability_image_c<0~(n-1)>_exposure_rangetype" is "onevalue".

NAME	VALUE	SECURITY (get/set)	DESCRIPTION
			<p>* We support this parameter when the version number (httpversion) is equal or greater than 0302a.</p>
<p>exposure_automode_affect</p>	<p>-, exposurewin.mode .blc:hidden;, defog:disabled;, wdrpro:disabled;, exposurelevel:hidde n;, or others <x>: nonnegative integer <product dependent></p>	<p>0/7</p>	<p>When exposure auto mode is enabled, some features may become malfunction or be forced to a given value. The affected functions are list here.</p> <p>The format is "Affect API name":"Policy":"Description"</p> <p>"Policy" can be categorized into following groups:</p> <ul style="list-style-type: none"> - (disabled) : UI turns grey and users can't select it. - (unchanged) : UI keeps the status as before and user can't change it. - (hidden) : UI is hidden. - (fixed) : UI is fixed to one selection or value. - (ranged) : UI is fixed to multiple selections or values. - (enabled) : UI is checked. - (notsupport) : the affected function is not available. <p>"Affect API name" can be described in hierarchy, such as "exposurewin.mode.blc:disabled:" which means blc exposure window is disabled. API name can be one word as well, such as "exposurelevel:fixed:6" which means exposurelevel is fixed to level 6.</p> <p>"Description" can be a nonnegative integer or string or NULL.</p> <p>"-" means no feature is affected.</p>

NAME	VALUE	SECURITY (get/set)	DESCRIPTION
			<p>* Only available when auto is listed in "capability_image_c<0~(n-1)>_exposure_modetype" and "capability_image_c<0~(n-1)>_exposure_mode" is 1.</p> <p>* We support this parameter when the version number (httpversion) is equal or greater than 0302a.</p>
exposure_shutterprioritymode_affect	<p>-, exposurewin.mode .blc:hidden:, defog:disabled:, wdrpro:disabled:, exposurelevel:hidden:, or others <x>: nonnegative integer <product dependent></p>	0/7	<p>When exposure shutter priority mode is enabled, some features may become malfunction or be forced to a given value. The affected functions are list here.</p> <p>The format is "Affect API name": "Policy": "Description"</p> <p>"Policy" can be categorized into following groups:</p> <ul style="list-style-type: none"> - (disabled) : UI turns grey and users can't select it. - (unchanged) : UI keeps the status as before and user can't change it. - (hidden) : UI is hidden. - (fixed) : UI is fixed to one selection or value. - (ranged) : UI is fixed to multiple selections or values. - (enabled) : UI is checked. - (notsupport) : the affected function is not available. <p>"Affect API name" can be described in hierarchy, such as "exposurewin.mode.blc:disabled:" which means blc exposure window is disabled. API name can be one word as well, such as</p>

NAME	VALUE	SECURITY (get/set)	DESCRIPTION
			<p>"exposurelevel:fixed:6" which means exposurelevel is fixed to level 6.</p> <p>"Description" can be a nonnegative integer or string or NULL.</p> <p>"-" means no feature is affected.</p> <p>* Only available when shutterpriority is listed in</p> <p>"capability_image_c<0~(n-1)>_exposure_modetype" and "capability_image_c<0~(n-1)>_exposure_mode" is 1.</p> <p>* We support this parameter when the version number (httpversion) is equal or greater than 0302a.</p>
<p>exposure_irispriority mode_affect</p>	<p>-, exposurewin.mode .blc:hidden:, defog:disabled:, wdrpro:disabled:, exposurelevel:hid den:, or others <x>: nonnegative integer <product dependent></p>	<p>0/7</p>	<p>When exposure iris priority mode is enabled, some features may become malfunction or be forced to a given value. The affected functions are list here.</p> <p>The format is "Affect API name":"Policy":"Description"</p> <p>"Policy" can be categorized into following groups:</p> <ul style="list-style-type: none"> - (disabled) : UI turns grey and users can't select it. - (unchanged) : UI keeps the status as before and user can't change it. - (hidden) : UI is hidden. - (fixed) : UI is fixed to one selection or value. - (ranged) : UI is fixed to multiple selections or values. - (enabled) : UI is checked. - (notsupport) : the affected function is not available.

NAME	VALUE	SECURITY (get/set)	DESCRIPTION
			<p>"Affect API name" can be described in hierarchy, such as "exposurewin.mode.blc:disabled:" which means blc exposure window is disabled. API name can be one word as well, such as "exposurelevel:fixed:6" which means exposurelevel is fixed to level 6. "Description" can be a nonnegative integer or string or NULL. "-" means no feature is affected. * Only available when irispriority is listed in "capability_image_c<0~(n-1)>_exposure_modetype" and "capability_image_c<0~(n-1)>_exposure_mode" is 1. * We support this parameter when the version number (httpversion) is equal or greater than 0302a.</p>
exposure_qualityprioritymode_affect	-, exposurewin.mode.blc:hidden:, defog:disabled:, wdrpro:disabled:, exposurelevel:hidden:, or others <x>: nonnegative integer <product dependent>	0/7	When exposure quality priority mode is enabled, some features may become malfunction or be forced to a given value. The affected functions are list here. The format is "Affect API name":"Policy":"Description" "Policy" can be categorized into following groups: - (disabled) : UI turns grey and users can't select it. - (unchanged) : UI keeps the status as before and user can't change it. - (hidden) : UI is hidden. - (fixed) : UI is fixed to one selection or

NAME	VALUE	SECURITY (get/set)	DESCRIPTION
			<p>value.</p> <ul style="list-style-type: none"> - (ranged) : UI is fixed to multiple selections or values. - (enabled) : UI is checked. - (notsupport) : the affected function is not available. <p>"Affect API name" can be described in hierarchy, such as "exposurewin.mode.blc:disabled:" which means blc exposure window is disabled. API name can be one word as well, such as "exposurelevel:fixed:6" which means exposurelevel is fixed to level 6. "Description" can be a nonnegative integer or string or NULL. "-" means no feature is affected. * Only available when qualitypriority is listed in "capability_image_c<0~(n-1)>_exposure_modetype" and "capability_image_c<0~(n-1)>_exposure_mode" is 1. * We support this parameter when the version number (httpversion) is equal or greater than 0305a.</p>
exposure_manualmode_affect	-, exposurewin.mode.blc:hidden;, defog:disabled;, wdrpro:disabled;, exposurelevel:hidden;, or others <x>: nonnegative integer	0/7	<p>When exposure manual mode is enabled, some features may become malfunction or be forced to a given value. The affected functions are list here.</p> <p>The format is "Affect API name": "Policy": "Description" "Policy" can be categorized into following groups:</p> <ul style="list-style-type: none"> - (disabled) : UI turns grey and users

NAME	VALUE	SECURITY (get/set)	DESCRIPTION
	<product dependent>		<p>can't select it.</p> <ul style="list-style-type: none"> - (unchanged) : UI keeps the status as before and user can't change it. - (hidden) : UI is hidden. - (fixed) : UI is fixed to one selection or value. - (ranged) : UI is fixed to multiple selections or values. - (enabled) : UI is checked. - (notsupport) : the affected function is not available. <p>"Affect API name" can be described in hierarchy, such as "exposurewin.mode.blc:disabled:" which means blc exposure window is disabled. API name can be one word as well, such as "exposurelevel:fixed:6" which means exposurelevel is fixed to level 6. "Description" can be a nonnegative integer or string or NULL. "-" means no feature is affected.</p> <p>* Only available when manual is listed in "capability_image_c<0~(n-1)>_exposure_modetype" and "capability_image_c<0~(n-1)>_exposure_mode" is 1.</p> <p>* We support this parameter when the version number (httpversion) is equal or greater than 0302a.</p>
exposure_levelrange	-, "0,12"	0/7	<p>Available range for "videoin_c<0~(n-1)>_exposurelevel"</p> <ul style="list-style-type: none"> * When "exposure_mode"=0, this value must be set to "-". * Only available when

NAME	VALUE	SECURITY (get/set)	DESCRIPTION
			"capability_image_c<0~(n-1)>_exposure_mode" is 1.
exposure_winmode	auto, custom, blc, hlc, center, - <product dependent>	0/7	Available options for "exposurewin_c<0~(n-1)>_mode" * "-" means group: exposurewin is not supported. * When exposure_mode="0", this value must be set to "-". * Only available when "capability_image_c<0~(n-1)>_exposure_mode" is 1.
exposure_meteringmode	auto, blc, hlc <product dependent>	0/7	Available options for "videoin_c<0~(n-1)>_meteringmode" * Only available when "capability_image_c<0~(n-1)>_exposure_mode" is 1.
exposure_hlcmode_supportwindow	<boolean>	0/7	Indicate whether to support exposure window in hlc mode. * Only available when "capability_image_c<0~(n-1)>_exposure_mode" is 1 and hlc is listed in "capability_image_c<0~(n-1)>_exposure_winmode".
exposure_hlcmode_affect	-, or others <x>: nonnegative integer <product dependent>	0/7	When hlc mode is enabled, some features may become malfunction or be forced to a given value. The affected functions are list here. The format is "Affect API name":"Policy":"Description" "Policy" can be categorized into following groups: - (disabled) : UI turns grey and users can't select it. - (unchanged) : UI keeps the status as before and user can't change it.

NAME	VALUE	SECURITY (get/set)	DESCRIPTION
			<ul style="list-style-type: none"> - (hidden) : UI is hidden. - (fixed) : UI is fixed to one selection or value. - (ranged) : UI is fixed to multiple selections or values. - (enabled) : UI is checked. - (notsupport) : the affected function is not available. <p>"Affect API name" can be described in hierarchy, such as "exposurewin.mode.blc:disabled:" which means blc exposure window is disabled. API name can be one word as well, such as "exposurelevel:fixed:6" which means exposurelevel is fixed to level 6.</p> <p>"Description" can be a nonnegative integer or string or NULL.</p> <p>"-" means no feature is affected.</p> <p>* Only available when "capability_image_c<0~(n-1)>_exposure_mode" is 1 and hlc is listed in "capability_image_c<0~(n-1)>_exposure_winmode".</p> <p>* We support this parameter when the version number (httpversion) is equal or greater than 0304a.</p>
exposure_wintype	inclusive, exclusive, -	0/7	<p>The supported exposure window type.</p> <p>"inclusive": The image inside a window is the target area of exposure control.</p> <p>"exclusive": The image inside a window is omitted by exposure control.</p> <p>"-": Not supported.</p> <p>* Only available when</p>

NAME	VALUE	SECURITY (get/set)	DESCRIPTION
			"capability_image_c<0~(n-1)>_exposure_mode" is 1.
exposure_windomain	qvga, px, std, -	0/7	The domain to set an exposure window. "qvga" : a 320x240 range to represent the whole image. "px" : Locate a window in the image with pixels. "std" : A normalized 0~9999 range. "-" : Not supported. * Only available when "capability_image_c<0~(n-1)>_exposure_mode" is 1.
exposure_winum	0, <Positive Integer>	0/7	Indicate the number of custom exposure windows. * If no "custom" is listed in "exposure_winmode", this should be 0. * Only available when "capability_image_c<0~(n-1)>_exposure_mode" is 1.
exposure_ntsc_totalrange	A list of <Positive Integer>	0/7	Available total range for NTSC analog output. * Only available when "capability_image_c<0~(n-1)>_exposure_mode" is 1. * We support this parameter when the version number (httpversion) is equal or greater than 0301a.
exposure_pal_totalrange	A list of <Positive Integer>	0/7	Available total range for PAL analog output. * Only available when "capability_image_c<0~(n-1)>_exposure_mode" is 1. * We support this parameter when the version number (httpversion) is

NAME	VALUE	SECURITY (get/set)	DESCRIPTION
			equal or greater than 0301a.
exposure_maxrange	"1,32000", "1,8000", -, or others <product dependent>	0/7	Available range for "videoin_c<n>_maxexposure" "1,32000" => 1s ~ 1/32000s "1,8000" => 1s ~ 1/8000s etc. "- " means maximum exposure time is not available. * When "exposure_mode"=0, this value must be set to "-". * Only available when "capability_image_c<0~(n-1)>_ exposure_mode" is 1.
exposure_minrange	"1,32000", "1,8000", -, or others <product dependent>	0/7	Available range for "videoin_c<n>_minexposure" "1,32000" => 1s ~ 1/32000s "1,8000" => 1s ~ 1/8000s etc. "- " means minimum exposure time is not available. * When "exposure_mode"=0, this value must be set to "-". * Only available when "capability_image_c<0~(n-1)>_ exposure_mode" is 1.
exposure_bracketing_ mode	<boolean>	0/7	0: Non-support Auto Exposure Bracketing (AEB) 1: Support Auto Exposure Bracketing (AEB) Auto Exposure Bracketing (AEB) is a term that is used to signify a process where the camera automatically takes two or more exposures but with different exposure values. * Only available when "capability_image_c<0~(n-1)>_ exposure_mode" is 1.

NAME	VALUE	SECURITY (get/set)	DESCRIPTION
			exposure_mode" is 1. * We support this parameter when the version number (httpversion) is equal or greater than 0310a.
exposure_bracketing_range	A list of ratio For example: 2x,3x,4x	0/7	The input parameter decides how much ratio of exposure compensation will be expanded on the next stream, which is based on the original exposure time (first stream). * Only available when "capability_image_c<0~(n-1)>_exposure_bracketing_mode" is 1. * We support this parameter when the version number (httpversion) is equal or greater than 0310a.
privacymask_wintype	rectangle, polygon, 3Drectangle	0/7	The supported mask window type. " polygon ": The window is a 2D polygon shape. " rectangle ": The window is a 2D rectangle shape. " 3Drectangle ": The window is a 3D rectangle shape.
privacymask_window	qvga, px, std, -	0/7	The domain to set an window. " qvga ": a 320x240 range to represent the whole image. " px ": Locate a window in the image with pixels. " std ": A normalized 0~9999 range. "-": Not supported.
privacymask_ncolor	<Positive Integer>	0/7	Available total color numbers of privacy mask.
agc_maxgain	"0,100", "-"	0/7	Available range for "videoin_c<n>_maxgain" "0,100" => 0~100 percent "-" means "videoin_c<n>_maxgain" is not available.

NAME	VALUE	SECURITY (get/set)	DESCRIPTION
agc_mingain	"0,100", "-"	0/7	Available range for "videoin_c<n>_mingain" "0,100" => 0~100 percent "-" means "videoin_c<n>_mingain" is not available.
flickerless	0,1	0/7	0: Non-support flickerless 1: Support flickerless
flickerlessaffect	-, minexposure:hidde n;, mingain:hidden;, or others <x>: nonnegative integer <product dependent>	0/7	When flickerless is enabled, some features may become malfunction or be forced to a given value. The affected functions are list here. The format is "Affect API name":"Policy":"Description" "Policy" can be categorized into following groups: - (disabled) : UI turns grey and users can't select it. - (unchanged) : UI keeps the status as before and user can't change it. - (hidden) : UI is hidden. - (fixed) : UI is fixed to one selection or value. - (ranged) : UI is fixed to multiple selections or values. - (enabled) : UI is checked. - (notsupport) : the affected function is not available. "Affect API name" can be described in hierarchy, such as "exposurewin.mode.blc:disabled:" which means blc exposure window is disabled. API name can be one word as well, such as "exposurelevel:fixed:6" which means exposurelevel is fixed to level 6.

NAME	VALUE	SECURITY (get/set)	DESCRIPTION
			"Description" can be a nonnegative integer or string or NULL. "-" means no feature is affected. * When "flickerless" = 0, this value must be "-"
defog_mode	0,1	0/7	0: Non-support defog 1: Support defog
defog_strength	0, 1	0/7	0: Non-support tuning strength of defog 1: Support tuning strength of defog * If "capability_image_c<0~(n-1)>_defog_mode"=1, this may be either 0 or 1.
defog_supportlevel	0, <positive integer>	0/7	The value indicate the support strength level of defog.
defog_affect	-, wdrpro:unchanged ;, or others <x>: nonnegative integer <product dependent>	0/7	When defog is enabled, some features may become malfunction or be forced to a given value. The affected functions are list here. The format is "Affect API name":"Policy":"Description" "Policy" can be categorized into following groups: - (disabled) : UI turns grey and users can't select it. - (unchanged) : UI keeps the status as before and user can't change it. - (hidden) : UI is hidden. - (fixed) : UI is fixed to one selection or value. - (ranged) : UI is fixed to multiple selections or values. - (enabled) : UI is checked. - (notsupport) : the affected function is not available.

NAME	VALUE	SECURITY (get/set)	DESCRIPTION
			<p>"Affect API name" can be described in hierarchy, such as</p> <p>"exposurewin.mode.blc:disabled:" which means blc exposure window is disabled. API name can be one word as well, such as</p> <p>"exposurelevel:fixed:6" which means exposurelevel is fixed to level 6.</p> <p>"Description" can be a nonnegative integer or string or NULL.</p> <p>"-" means no feature is affected.</p> <p>* When "defog" = 0, this value must be "-"</p>
aespeed	0,1	0/7	<p>0: Non-support AE speed</p> <p>1: Support AE speed</p>
aespeedsupportlevel	<positive integer>	0/7	<p>The value indicate the support strength level of aespeed.</p> <p>* Only available when "capability_image_c<0~(n-1)>_aespeed" is 1.</p>
aespeedsupportssensitivity	0,1	0/7	<p>0: Non-support tuning the sensitivity of AE converge speed.</p> <p>1: Support tuning the sensitivity of AE converge speed.</p> <p>* Only available when "capability_image_c<0~(n-1)>_aespeed" is 1.</p>
gammacurve	0,1	0/7	<p>0: Non-support tuning Gamma curve</p> <p>1: Support tuning Gamma curve</p>
lowlightmode	-,0,1	0/7	<p>-: Internal parameter, must not open to user.</p> <p>0: Non-support low light mode</p> <p>1: Support low light mode</p>
focusassist	0,1	0/7	<p>0: Non-support focus assist</p> <p>1: Support focus assist</p>
remotefocus	0,<positive	0/7	An 4-bit integer, which indicates the

NAME	VALUE	SECURITY (get/set)	DESCRIPTION
	integer>		<p>supportive application of remotefocus in this channel.</p> <p>If the value of this parameter is larger than 0, it means that the camera supports remotefocus function in this channel.</p> <p>bit 0 => Indicate whether to support both zoom and focus function.</p> <p>bit 1 => Only support zoom function.</p> <p>bit 2 => Only support focus function.</p> <p>bit 3 => Currently, this is a reserved bit, and the default value is 0.</p>
focuswindowmain	qvga, px, std, -	0/7	<p>The domain to set a focus window.</p> <p>"qvga": a 320x240 range to represent the whole image.</p> <p>"px": Locate a window in the image with pixels.</p> <p>"std": A normalized 0~9999 range.</p> <p>"-": Not supported.</p>
focuswindow_nwindow	0,<positive integer>	0/7	Number of focus window
focuswindow_range	<leftrange,rightrange,toprange,lowrange> <product dependent>	0/7	<p>Available range for focuswindow.</p> <p>* We support this parameter when the version number (httpversion) is equal or greater than 0305d.</p> <p>*-: Not supported.</p>
lensconfiguration_support	0,1	0/7	Indicate whether to support different image library configuration files for specific exchangeable lens.
freeze	<boolean>	0/7	<p>0: Non-support image freeze feature</p> <p>1: Support image freeze feature</p> <p>* We support this parameter when the version number (httpversion) is equal or greater than 0302a.</p>
autotrack_support	<boolean>	0/7	0: Non-support auto tracking feature

NAME	VALUE	SECURITY (get/set)	DESCRIPTION
			1: Support auto tracking feature * We support this parameter when the version number (httpversion) is equal or greater than 0302a.
smartsensor_iris_total_range	A list of iris value	0/7	Available total step for iris value. * We support this parameter when the version number (httpversion) is equal or greater than 0302a. * Only available when "capability_image_c<0~(n-1)>_sensor_type" is "smartsensor"
deinterlace_support	<boolean>	0/7	Indicate whether to support deinterlace function. * We support this parameter when the version number (httpversion) is equal or greater than 0308a.
deinterlace_mode	spatial, blend	0/7	Spatial mode provides the best image quality, while Blend mode provides better image quality (than not using the deinterlace function at all). * Only available when capability_image_c<0~(n-1)>_deinterlace_support is 1
lens_alignment	<boolean>	0/7	Indicate whether to support lens alignment function. * We support this parameter when the version number (httpversion) is equal or greater than 0309b.
lens_alignmentlevel	<positive integer>	0/7	The value indicate the support level of alignment. * Only available when "capability_image_c<0~(n-1)>_lens_alignment" is 1.
lens_ldc_support	<boolean>	0/7	Indicate whether to support lens distortion correction function.

NAME	VALUE	SECURITY (get/set)	DESCRIPTION
			* We support this parameter when the version number (httpversion) is equal or greater than 0309d.
palette_support	<boolean>	0/7	Indicate support color palettes or not. Thermal cameras provide a choice of color palettes on the camera, that help quickly distinguish thermal variations and patterns in an image. The color tones correspond to the apparent surface temperatures of the target. * We support this parameter when the version number (httpversion) is equal or greater than 0310a.
palette_mode	A list of palette options	0/7	Palette options used in thermal surveillance. *Only available when "capability_image_c<0~(n-1)>_palette_support"=1. * We support this parameter when the version number (httpversion) is equal or greater than 0310a.

Group: **capability_peripheral_c<0~(n-1)>** n denotes the value of "capability_nvideoin"

PARAMETER	VALUE	SECURITY (get/set)	DESCRIPTION
devicecontrol	<boolean>	0/7	Indicate whether to support the peripheral device control. * We support this parameter when the version number (httpversion) is equal or greater than 0305c.

7.28 Customized Event Script

Group: **event_customtaskfile_i<0~2>**

PARAMETER	VALUE	SECURITY (get/set)	DESCRIPTION
name	string[40]	6/6	Custom script identification of this entry.
date	string[4~20]	6/6	Date of custom script.
time	string[4~20]	6/6	Time of custom script.

7.29 Event Setting

Group: **event_i<0~(n-1)>** n denotes the value of "capability_nevent"

(capability_nevent > 0)

PARAMETER	VALUE	SECURITY (get/set)	DESCRIPTION
name	string[40]	6/6	Identification of this entry.
enable	0, 1	6/6	Enable or disable this event.
priority	0, 1, 2	6/6	Indicate the priority of this event: "0"= low priority "1"= normal priority "2"= high priority
delay	1~999	6/6	Delay in seconds before detecting the next event.

PARAMETER	VALUE	SECURITY (get/set)	DESCRIPTION
trigger	boot, di, pir, motion, seq, recnotify, tampering, vi, volalarm, visignal, vadp, smartsd <product dependent>	6/6	Indicate the trigger condition: "boot" = System boot. "di" = Digital input. "pir" = PIR detection. "motion" = Video motion detection. "seq" = Periodic condition. "visignal" = Video input signal loss. "recnotify" = Recording notification. "tampering" = Tamper detection. "vi" = Virtual input (Manual trigger). "volalarm" = Audio detection. "smartsd" = Lifetime detection of SD card. "shockalarm" = Shock detection. "virestore" = Video input signal restore. "vadp" = VADP trigger. * "smartsd" is only valid when smart SD card is inserted
triggerstatus	string[40]	6/6	The status for event trigger
di	0,<positive integer>	6/6	Indicate the source id of di trigger. This field is required when trigger condition is "di". One bit represents one digital input. The LSB indicates DI 0. * Only available when "capability_ndi" > 0
mdwin	0,<positive integer>	6/6	Indicate the source window id of motion detection. This field is required when trigger condition is "md". One bit represents one window. The LSB indicates the 1 st window. For example, to detect the 1 st and 3 rd windows, set mdwin as 5.
mdwin0	0,<positive integer>	6/6	Similar to mdwin. The parameter takes effect when profile 1 of motion detection is enabled.

PARAMETER	VALUE	SECURITY (get/set)	DESCRIPTION
vi	0,<positive integer>	6/6	Indicate the source id of vi trigger. This field is required when trigger condition is "vi". One bit represents one digital input. The LSB indicates VI 0.
vadp <product dependent>	0,<positive integer>	6/6	Indicate the source id of vadp event notification. Each bit corresponds to one vadp source, and the LSB indicates source id 0. For example, to detect event from any one of source id 0, 1 and 3, set vadp to 11. * Only available when vadp is listed in "capability_supporttriggertypes"
valevel	0,1	6/6	Select audio detection event. 0: not select 1: select
valevel0	0,1	6/6	Select audio detection profile event. 0: not select 1: select
inter	1~999	6/6	Interval of snapshots in minutes. This field is used when trigger condition is "seq".
weekday	0~127	6/6	Indicate which weekday is scheduled. One bit represents one weekday. bit0 (LSB) = Saturday bit1 = Friday bit2 = Thursday bit3 = Wednesday bit4 = Tuesday bit5 = Monday bit6 = Sunday For example, to detect events on Friday and Sunday, set weekday as 66.
begintime	hh:mm	6/6	Begin time of the weekly schedule.

PARAMETER	VALUE	SECURITY (get/set)	DESCRIPTION
endtime	hh:mm	6/6	End time of the weekly schedule. (00:00 ~ 24:00 sets schedule as always on)
lowlightcondition <product dependent>	0, 1	6/6	Switch on white light LED in low light condition 0 => Do action at all times 1 => Do action in low-light conditions
action_do_i<0~(ndo-1)>_enable	<boolean>	6/6	Enable or disable trigger digital output. * Only available when "capability_ndo" > 0
action_do_i<0~(ndo-1)>_duration	1~999	6/6	Duration of the digital output trigger in seconds. * Only available when "capability_ndo" > 0
action_cf_enable	<Boolean>	6/6	Enable or disable sending media to SD card. * Only available when "capability_supportsd" > 0
action_cf_folder	string[128]	6/6	Path to store media. * Only available when "capability_supportsd" > 0
action_cf_media	NULL, 0~4,101	6/6	Index of the attached media. 101 means "Recording Notify" * Only available when "capability_supportsd" > 0
action_cf_datefolder	<boolean>	6/6	Enable this to create folders by date, time, and hour automatically. * Only available when "capability_supportsd" > 0
action_cf_backup	<Boolean>	6/6	Enable or disable the function that send media to SD card for backup if network is disconnected. * Only available when "capability_supportsd" > 0
action_server_i<0~4>_enable	<boolean>	6/6	Enable or disable this server action.

PARAMETER	VALUE	SECURITY (get/set)	DESCRIPTION
action_server_i<0~4>_media	NULL, 0~4,101	6/6	Index of the attached media. 101 means "Recording Notify"
action_server_i<0~4>_datefolder	<boolean>	6/6	Enable this to create folders by date, time, and hour automatically.
action_goto_enable <product dependent>	<boolean>	6/6	Enable/disable ptz goto preset position on event triggered. * Only available when "capability_ptzenabled" > 0.
action_goto_name <product dependent>	string[40]	6/6	Specify the preset name that ptz goto on event triggered. * Only available when "capability_ptzenabled" > 0.
action_goto_sync <product dependent>	<boolean>	6/6	Capture media after moving to the location. * Only available when the bit4 of capability_ptzenabled is 1 and the bit7 of capability_ptzenabled is 0, or capability_camctrl_c0_zoommodule > 0
action_autotrack_enable <product dependent>	<boolean>	6/6	Enable/disable auto tracking on event triggered. * Only available when the bit4 of capability_ptzenabled is 1 and the bit7 of capability_ptzenabled is 0
action_audioclip_enable	<boolean>	6/6	Enable/disable the function the play an audio clip when an event is triggered. * Only available when "capability_audio_audioclip" is 1.
action_audioclip_media	0,<positive integer>	6/6	Indicate the source id of audioclip event notification. * Only available when "capability_audio_audioclip" is 1.

PARAMETER	VALUE	SECURITY (get/set)	DESCRIPTION
tampering	0,<positive integer>	6/6	Indicate the source channel id of tampering detection. A 4-bit integer, each bit represents each channel. bit 0 => tampering detection for first channel. bit 1 => tampering detection for second channel. bit 2 => tampering detection for third channel. bit 3 => tampering detection for fourth channel.

7.30 Server Setting for Event Action

Group: **server_i<0~4>**

PARAMETER	VALUE	SECURITY (get/set)	DESCRIPTION
name	string[40]	6/6	Identification of this entry
type	email, ftp, http, ns	6/6	Indicate the server type: "email" = email server "ftp" = FTP server "http" = HTTP server "ns" = network storage
http_url	string[128]	6/6	URL of the HTTP server to upload.
http_username	string[64]	6/6	Username to log in to the server.
http_passwd	string[64]	7/6	Password of the user.
ftp_address	string[128]	6/6	FTP server address.
ftp_username	string[64]	6/6	Username to log in to the server.
ftp_passwd	string[64]	7/6	Password of the user.
ftp_port	0~65535	6/6	Port to connect to the server.
ftp_location	string[128]	6/6	Location to upload or store the media.

PARAMETER	VALUE	SECURITY (get/set)	DESCRIPTION
ftp_passive	<boolean>	6/6	Enable or disable passive mode. 0 = disable passive mode 1 = enable passive mode
email_address	string[128]	6/6	Email server address.
email_sslmode	<boolean>	6/6	Enable support SSL.
email_port	0~65535	6/6	Port to connect to the server.
email_username	string[64]	6/6	Username to log in to the server.
email_passwd	string[64]	7/6	Password of the user.
email_senderemail	string[128]	6/6	Email address of the sender.
email_recipientemail	string[640]	6/6	Email address of the recipient.
ns_location	string[128]	6/6	Location to upload or store the media.
ns_username	string[64]	6/6	Username to log in to the server.
ns_passwd	string[64]	7/6	Password of the user.
ns_workgroup	string[64]	6/6	Workgroup for network storage.

7.31 Media Setting for Event Action

Group: **media_i**<0~(n-1)> n denotes the value of "capability_media_num"
(capability_media_num > 0)

PARAMETER	VALUE	SECURITY (get/set)	DESCRIPTION
Name	string[40]	6/6	Identification of this entry
Type	snapshot, systemlog, videoclip, recordmsg	6/6	Media type to send to the server or store on the server.
snapshot_channel	0~"capability_nvideoin"-1	6/6	Indicate the source of media channel. 0 means the first channel. 1 means the second channel. 2 means the third channel. 3 means the fourth channel. * We support this parameter when the version number (httpversion) is equal or greater than 0311c.
snapshot_source	0~"capability_nmediastream" "-1	6/6	Indicate the source of media stream. 0 means the first stream. 1 means the second stream and etc. 2 means the third stream and etc. 3 means the fourth stream and etc.
snapshot_prefix	string[16]	6/6	Indicate the prefix of the filename. media_i0=> Snapshot1_ media_i1=> Snapshot2_ media_i2=> Snapshot3_ media_i3=> Snapshot4_ media_i4=> Snapshot5_

PARAMETER	VALUE	SECURITY (get/set)	DESCRIPTION
snapshot_datesuffix	0, 1	6/6	Add date and time suffix to filename: 1 = Add date and time suffix. 0 = Do not add.
snapshot_preevent	0~" capability_media_snapshot_ maxpreevent"	6/6	Indicates the number of pre-event images.
snapshot_postevent	0~" capability_media_snapshot_ maxpostevent"	6/6	Indicates the number of post-event images.
videoclip_channel	0~"capability_nvideoin"-1	6/6	Indicate the source of media channel. 0 means the first channel. 1 means the second channel. 2 means the third channel. 3 means the fourth channel. * We support this parameter when the version number (httpversion) is equal or greater than 0311c.
videoclip_source	0~"capability_nmediastream"-1	6/6	Indicate the source of media stream. 0 means the first stream. 1 means the second stream and etc. 2 means the third stream and etc. 3 means the fourth stream and etc.
videoclip_prefix	string[16]	6/6	Indicate the prefix of the filename.
videoclip_preevent	0 ~ " capability_media_videoclip_ maxpreevent"	6/6	Indicates the time for pre-event recording in seconds.
videoclip_maxduration	1 ~ " capability_media_videoclip_ maxlength"	6/6	Maximum duration of one video clip in seconds.

PARAMETER	VALUE	SECURITY (get/set)	DESCRIPTION
videoclip_maxsize	50 ~ " capability_media_videoclip_ maxsize"	6/6	Maximum size of one video clip file in Kbytes.

7.32 Recording

Group: **recording_i**<0~(n-1)> n denotes the value of "capability_nrecording"

(capability_nrecording > 0)

PARAMETER	VALUE	SECURITY (get/set)	DESCRIPTION
name	string[40]	6/6	Identification of this entry.
trigger	schedule, networkfail	6/6	The event trigger type schedule: The event is triggered by schedule networkfail: The event is triggered by the failure of network connection.
enable	<boolean>	6/6	Enable or disable this recording.
priority	0, 1, 2	6/6	Indicate the priority of this recording: "0" indicates low priority. "1" indicates normal priority. "2" indicates high priority.
channel	0~"capability_nvideoin"-1	6/6	Indicate the source of recording channel. 0 means the first channel. 1 means the second channel. 2 means the third channel. 3 means the fourth channel. * We support this parameter when the version number (httpversion) is equal or greater than 0311c.
source	0~"capability_nmediastrea m"-1	6/6	Indicate the source of media stream. 0 means the first stream. 1 means the second stream and so on.

PARAMETER	VALUE	SECURITY (get/set)	DESCRIPTION
maxretentiontime	<string>	6/6	To specify the expired time for automatic clean up, and it only takes effect for video clip generated by recording_i <0~1>. Format is "P[Y]Y[MM]M[DDD]DT[hh]H[mm]M[ss]S', similar with ISO8601 with symbols P. Ex. P7D, it means 7 days. P1DT10H, it means 1 days and 10 hours. The parameter takes effect when autocleanup_maxretentiontime_recording_enabled is enabled.
limitsize	<boolean>	6/6	0: Entire free space mechanism 1: Limit recording size mechanism
cyclic	<boolean>	6/6	0: Disable cyclic recording 1: Enable cyclic recording
notify	<boolean>	6/6	0: Disable recording notification 1: Enable recording notification
notifyserver	0~31	6/6	Indicate which notification server is scheduled. One bit represents one application server (server_i0~i4). bit0 (LSB) = server_i0. bit1 = server_i1. bit2 = server_i2. bit3 = server_i3. bit4 = server_i4. For example, enable server_i0, server_i2, and server_i4 as notification servers; the notifyserver value is 21.

PARAMETER	VALUE	SECURITY (get/set)	DESCRIPTION
weekday	0~127	6/6	Indicate which weekday is scheduled. One bit represents one weekday. bit0 (LSB) = Saturday bit1 = Friday bit2 = Thursday bit3 = Wednesday bit4 = Tuesday bit5 = Monday bit6 = Sunday For example, to detect events on Friday and Sunday, set weekday as 66.
begintime	hh:mm	6/6	Start time of the weekly schedule.
endtime	hh:mm	6/6	End time of the weekly schedule. (00:00~24:00 indicates schedule always on)
prefix	string[16]	6/6	Indicate the prefix of the filename.
cyclesize	100~	6/6	The maximum size for cycle recording in Kbytes when choosing to limit recording size.
reserveamount	0~15000000	6/6	The reserved amount in Mbytes when choosing cyclic recording mechanism.
dest	cf, 0~4	6/6	The destination to store the recorded data. “cf” means local storage (CF or SD card). “0” means the index of the network storage.
cffolder	string[128]	6/6	Folder name.
maxsize	100~2000	6/6	Unit: Mega bytes. When this condition is reached, recording file is truncated.
maxduration	60~3600	6/6	Unit: Second When this condition is reached, recording file is truncated.
adaptive_enable	<boolean>	6/6	Indicate whether the adaptive recording is enabled

PARAMETER	VALUE	SECURITY (get/set)	DESCRIPTION
adaptive_preevent	0~9	6/6	Indicate when is the adaptive recording started before the event trigger point (seconds)
adaptive_postevent	0~10	6/6	Indicate when is the adaptive recording stopped after the event trigger point (seconds)

7.33 HTTPS

Group: **https** (`capability_protocol_https > 0`)

NAME	VALUE	SECURITY (get/set)	DESCRIPTION
enable	<boolean>	6/6	To enable or disable secure HTTP.
policy	<Boolean>	6/6	If the value is 1, it will force HTTP connection redirect to HTTPS connection
method	auto, manual, install	6/6	auto =>Create self-signed certificate automatically. manual =>Create self-signed certificate manually. install =>Create certificate request and install.
status	-3 ~ 1	6/6	Specify the https status. -3= Certificate not installed -2 = Invalid public key -1 = Waiting for certificate 0= Not installed 1 = Active
countryname	string[2]	6/6	Country name in the certificate information.
stateorprovincename	string[128]	6/6	State or province name in the certificate information.
localityname	string[128]	6/6	The locality name in the certificate information.
organizationname	string[64] VIVOTEK Inc.	6/6	Organization name in the certificate information.

NAME	VALUE	SECURITY (get/set)	DESCRIPTION
unit	string[64] VIVOTEK Inc.	6/6	Organizational unit name in the certificate information.
commonname	string[64] www.vivotek.com	6/6	Common name in the certificate information.
validdays	0 ~ 3650	6/6	Valid period for the certification.

7.34 Storage Management Setting

Group: **disk_i<0~(n-1)>** n is the total number of storage devices. (**capability_storage_dbenabled > 0**)
 Currently it's only for local storage (SD, CF card), so n is equal to 1.

PARAMETER	VALUE	SECURITY (get/set)	DESCRIPTION
cyclic_enabled	<boolean>	6/6	Enable cyclic storage method.
autocleanup_enabled <Not recommended to use this>	<boolean>	6/6	Enable automatic clean up method. Expired and not locked media files will be deleted. * For forward compatibility reservations, but only group disk_i0_autocleanup is effective. * Not recommended to use this. Please refers "autocleanup" group. * This parameter will not be used after the version number (httpversion) is equal or greater than 0400a.
autocleanup_maxage <Not recommended to use this>	<positive integer>	6/6	To specify the expired days for automatic clean up. * For forward compatibility reservations, but only group disk_i0_autocleanup is effective. * Not recommended to use this. Please refers "autocleanup" group. * This parameter will not be used after the version number (httpversion) is equal or greater than 0400a.

Group: **autocleanup** (*capability_localstorage_supportededge > 0*)

PARAMETER	VALUE	SECURITY (get/set)	DESCRIPTION
enabled	<boolean>	6/6	Enable automatic clean up method. Expired and not locked media files will be deleted.
maxretentiontime_recording_enabled	<boolean>	6/6	Enable automatic clean up method for video clip generated by recording task. The parameter takes effect when autocleanup_enabled is enabled.
maxretentiontime_recording_i<0~1>_maxage	<string>	6/6	To specify the expired time for automatic clean up, and it only takes effect for video clip generated by recording_i<0~1>. Format is “P[Y]Y[MM]M[DDD]DT[hh]H[mm]M[ss]S”, , similar with ISO8601 with symbols P Ex. P7D, it means 7 days. P1DT10H, it means 1 days and 10 hours. The parameter takes effect when autocleanup_maxretentiontime_recording_enabled is enabled.
maxretentiontime_others_enabled	<boolean>	6/6	Enable automatic clean up method for all media files except media files generated by recording task. The parameter takes effect when autocleanup_enabled is enabled.

PARAMETER	VALUE	SECURITY (get/set)	DESCRIPTION
maxretentiontime_others_maxage	<string>	6/6	To specify the expired time for automatic clean up, and it takes effect for all media files except media files generated by recording task. Format is “P[Y]Y[MM]M[DDD]DT[hh]H[mm]M[ss]S”, similar with ISO8601 with symbols P Ex. P7D, it means 7 days. P1DT10H, it means 1 days and 10 hours. The parameter takes effect when autocleanup_maxretentiontime_others_enabled is enabled.

7.35 Region of Interest

Group: **roi_c<0~(n-1)>** for n channel product and m is the index of video stream which support ePTZ.
(**capability_eptz > 0 or capability_fisheye = 1**)

PARAMETER	VALUE	SECURITY (get/set)	DESCRIPTION
s<0~(m-1)>_home	<W,H> <product dependent>	1/6	ROI left-top corner coordinate.* If the minimal window size is 64x64, then the "win_i0_home"=(0~resolution_W-64, 0~resolution_H-64), which the resolution is the value in current stream. * If the stream doesn't support ePTZ, the permissions of this parameter must be set as 1/7.

PARAMETER	VALUE	SECURITY (get/set)	DESCRIPTION
s<0~(m-1)>_size	<WxH> <product dependent>	1/6	ROI width and height. The width value must be multiples of 16 and the height value must be multiples of 8 * The minimal window size is 64x64, and then resolution_W, resolution_H is the value in current stream. * If the stream doesn't support ePTZ, the permissions of this parameter must be set as 1/7.

7.36 ePTZ Setting

Group: eptz_c<0~(n-1)> for n channel product. (capability_eptz > 0 or capability_fisheye = 1)

PARAMETER	VALUE	SECURITY (get/set)	DESCRIPTION
osdzoom <Not recommended to use this>	<boolean>	1/4	Indicates multiple of zoom in is "on-screen display" or not. * Reserved for compatibility, and suggest don't use this since [httpversion] > 0302a * We replace "eptz_c<0~(n-1)>_osdzoom" with "videoin_c<0~(n-1)>_zoomratiodisplay".
smooth	<boolean>	1/4	Enable the ePTZ "move smoothly" feature
tiltspeed	-5 ~ 5	1/4	Tilt speed * Only available when "capability_fisheye" is 1
		1/7	Tilt speed (It should be set by eCamCtrl.cgi rather than by setparam.cgi.)
panspeed	-5 ~ 5	1/4	Pan speed * Only available when "capability_fisheye" is 1
		1/7	Pan speed (It should be set by eCamCtrl.cgi rather than by setparam.cgi.)

PARAMETER	VALUE	SECURITY (get/set)	DESCRIPTION
zoomspeed	-5 ~ 5	1/4	Zoom speed * Only available when "capability_fisheye" is 1
		1/7	Zoom speed (It should be set by eCamCtrl.cgi rather than by setparam.cgi.)
autospeed	1 ~ 5	1/4	Auto pan/patrol speed * Only available when "capability_fisheye" is 1
		1/7	Auto pan/patrol speed (It should be set by eCamCtrl.cgi rather than by setparam.cgi.)
rotatespeed	1 ~ 5	1/4	Rotate speed (only for Fisheye series) * Only available when "capability_fisheye" is 1 and "capability_fisheylowdewarp_c<0~(n-1)>" is 0

Group: **eptz_c<0~(n-1)>_s<0~(m-1)>** for n channel product and m is the index of video stream which support ePTZ if capability_eptz > 0; m is the index of stream number if capability_fisheye = 1.
(capability_eptz > 0 or capability_fisheye = 1)

PARAMETER	VALUE	SECURITY (get/set)	DESCRIPTION
patrolseq	string[120]	1/4	The patrol sequence of ePTZ. All the patrol position indexes will be separated by ","
patroldwelling	string[160]	1/4	The dwelling time (unit: second) of each patrol point, separated by ",".
preset_i<0~19>_name	string[40]	1/4	Name of ePTZ preset. * Only available when "capability_fisheye" is 1
		1/7	Name of ePTZ preset. (It should be set by ePreset.cgi rather than by setparam.cgi.)

PARAMETER	VALUE	SECURITY (get/set)	DESCRIPTION
preset_i<0~19>_pos	<W,H> <product dependent>	1/4	Left-top corner coordinate of the preset. * Only available when "capability_fisheye" is 1
		1/7	Left-top corner coordinate of the preset. (It should be set by ePreset.cgi rather than by setparam.cgi.)
preset_i<0~19>_size	<WxH> <product dependent>	1/4	Width and height of the preset. * Only available when "capability_fisheye" is 1
		1/7	Width and height of the preset. (It should be set by ePreset.cgi rather than by setparam.cgi.)

7.37 Focus Window Setting

Group: **focuswindow_c<0~(n-1)>** for n channel products

n denotes the value of "capability_nvideoin".

(capability_image_c<0~(n-1)>_focuswindow_nwindow > 0)

PARAMETER	VALUE	SECURITY (get/set)	DESCRIPTION
win_i0_enable	<boolean>	4/4	Enable or disable the window.
win_i0_home	<W,H> <product dependent>	4/4	Left-top corner coordinate of the window. * If the minimal window size is 192x144, then the "win_i0_home"=(0~resolution_W-192, 0~resolution_H-144), resolution_W and resolution_H based on "capability_image_c<0~(n-1)>_focuswindow_range" .
win_i0_size	<WxH> <product dependent>	4/4	Width and height of the window. * The minimal window size is 192x144, and resolution_W and resolution_H is based on "capability_image_c<0~(n-1)>_focuswindow_range" .

7.38 Seamless Recording Setting

Group: **seamlessrecording**

(**capability_localstorage_seamless**> 0)

PARAMETER	VALUE	SECURITY (get/set)	DESCRIPTION
diskmode	seamless, manageable	1/6	“seamless” indicates enable seamless recording. “manageable” indicates disable seamless recording.
maxconnection	3	1/7	Maximum number of connected seamless streaming.
enable	<boolean>	1/7	Indicate whether seamless recording is recording to local storage or not at present. (Read only)
guid<0~2>_id	string[127]	1/7	The connected seamless streaming ID. (Read only)
guid<0~2>_number	0~3	1/7	Number of connected seamless streaming with guid<0~(k-1)>_id. (Read only)

7.39 VIVOTEK Application Development Platform Setting

Group: **vadp**

NAME	VALUE	SECURITY (get/set)	DESCRIPTION
version	<string>	6/7	Indicate the VADP version.
resource_total_memory	0,<positive integer>	6/7	Indicate total available memory size for VADP modules.
resource_total_storage	0,<positive integer>	6/7	Indicate total size of the internal storage space for storing VADP modules.
resource_free_memory	0,<positive	6/7	Indicate free memory size for VADP

NAME	VALUE	SECURITY (get/set)	DESCRIPTION
	integer>		modules.
resource_free_storage	0,<positive integer>	6/7	Indicate current free storage size for uploading VADP modules.
module_number	0,<positive integer>	6/7	Record the total module number that already stored in the system.
module_order	string[40]	6/6	The execution order of the enabled modules.
module_save2sd	<boolean>	6/6	Indicate if the module should be saved to SD card when user want to upload it. If the value is false, save module to the internal storage space and it will occupy storage size.
number	string[128]	6/7	This number is used to register license key for VADP application.

Group: **vadp_module_i<0~(n-1)>** for n VADP package number (**capability_vadp_npackage > 0**)
n denotes the value of "capability_vadp_npackage".

NAME	VALUE	SECURITY (get/set)	DESCRIPTION
enable	<boolean>	6/6	Indicate if the module is enabled or not. If yes, also add the index of this module to the module_order.
name	string[40]	6/6	Module name
extendedname	string[40]	6/6	Extended module name. If this value is not blank, it will be shown on the VADP UI first instead of vadp_module_i<n>_name.
url	string[120]	6/6	Define the URL string after the IP address if the module provides it own web page.
vendor	string[40]	6/6	The provider of the module.
vendorurl	string[120]	6/6	URL of the vendor.
version	string[40]	6/6	Version of the module.
license	string[40]	6/6	Indicate the license status of the module.
licmsg	string[128]	6/6	Indicate the message that will be show on license status when mouse over.
path	string[40]	6/6	Record the storage path of the module.
initscr	string[40]	6/6	The script that will handle operation commands from the system.
status	string[40]	6/6	Indicate the running status of the module.
statmsg	string[128]	6/6	Indicate the message that will be show on the running status when mouse over.
vtklicensemec	string[40]	6/7	Indicate the module use VIVOTEK license mechanism

Group: **vadp_schedule_i<0~(n-1)>** for n VADP package number
n denotes the value of "capability_vadp_npackage".

(Only available when "capability_vadp_npackage" > 0 and the version number of "vadp_version" >= "1.3.2.0")

NAME	VALUE	SECURITY (get/set)	DESCRIPTION
enable	<boolean>	6/6	Enable or disable the schedule mode to control the execution of the VADP package
begintime	hh:mm	6/6	Begin time of the schedule
endtime	hh:mm	6/6	End time of the schedule

Group: **vadp_event**

NAME	VALUE	SECURITY (get/set)	DESCRIPTION
ntrigger	0,<positive integer>	6/7	Indicate the number of topics to be transferred to event manager for trigger.
triggerlist_i<0~(n-1)>_topic	string[256]	6/6	Indicate the event notification with this topic will be transferred to event manager as trigger. n is equal to ntrigger above.

7.40 Camera PTZ Control

Group: **camctrl** (**capability_camctrl_ptztunnel > 0**)

NAME	VALUE	SECURITY (get/set)	DESCRIPTION
enableptztunnel	<boolean>	1/4	Enable PTZ tunnel for camera control.

Group: **camctrl_c<0~(n-1)>** for n channel products (**capability_ptzenabled > 0**)

n denotes the value of "capability_nvideoin" and k denotes the value of "capability_npreset"

NAME	VALUE	SECURITY (get/set)	DESCRIPTION
panspeed	-5 ~ 5	1/4	Pan speed
tiltspeed	-5 ~ 5	1/4	Tilt speed
zoomspeed	-5 ~ 5	1/4	Zoom speed
focusspeed	-5 ~ 5	1/4	Auto focus speed
patrolseq	string[120]	1/4	(For external device) The indexes of patrol points, separated by “,”
patroldwelling	string[160]	1/4	(For external device)

NAME	VALUE	SECURITY (get/set)	DESCRIPTION
			The dwelling time of each patrol point, separated by “,”
preset_j<0~(k-1)>_name	string[40]	1/4	Name of the preset location.
preset_j<0~(k-1)>_dwelling	0 ~ 999	1/4	The dwelling time of each preset location
uart	0 ~ "capability_uart"-1	1/4	Select corresponding uart (capability_uart>0).
cameraid	0~255	1/4	Camera ID controlling external PTZ camera.
isptz	0 ~ 2	1/4	0: disable PTZ commands. 1: enable PTZ commands with PTZ driver. 2: enable PTZ commands with UART tunnel. * Only available when bit7 of capability_ptzenabled is 1
disablemdonptz	<boolean>	1/4	Disable motion detection on PTZ operation.

7.41 Camera PTZ Control (IZ Series)

Group: `camctrl_c<0~(n-1)>` for n channel products (`capability_camctrl_c0_zoommodule = 1` and `capability_camctrl_c0_buildingpt = 0`)

n denotes the value of "capability_nvideoin" and k denotes the value of "capability_npreset"

NAME	VALUE	SECURITY (get/set)	DESCRIPTION
ccdtype	string[16]	6/7	(Internal used, read only)
motortype	string[16]	6/7	(Internal used, read only)
cameraid	0 ~ 255	1/4	<p>Camera ID controlling external PTZ camera.</p> <p>Note: Please set your speed dome to the appropriate baud rate, and Camera ID, e.g. 2400bps, camera ID 1,2,3,,,,etc. All Camera IDs on the same controlling system (NVR or rs485 keyboard) have to be distinct. Therefore, once you send a controlling signal, each camera will only accept the inputs with the corresponding ID.</p>
panspeed	-5 ~ 5	1/4	Pan speed
tiltspeed	-5 ~ 5	1/4	Tilt speed
zoomspeed	-5 ~ 5	1/4	Zoom speed
autospeed	-5 ~ 5	1/4	Auto pan speed
focusspeed	-5 ~ 5	1/4	Auto focus speed
focusmode	auto, onetimeauto, spotlight, manual * Available values are listed in "capability_camctrl_c<0~(n-1)>_focusmode"	1/4	Indicate the focus control mode.
uart	0 ~ "capability_nua	1/4	Select corresponding uart (<code>capability_nuart>0</code>).

NAME	VALUE	SECURITY (get/set)	DESCRIPTION
	rt"-1		
isptz	0 ~ 2	1/4	0: disable PTZ commands. 1: enable PTZ commands with PTZ driver. 2: enable PTZ commands with UART tunnel. * Only available when bit7 of capability_ptzenabled is 1
preset_i<0~(k-1)>_name	string[40]	1/4	Name of the preset location.
preset_i<0~(k-1)>_zoom	capability_ptz_ c<0~(n-1)>_min zoom ~ capability_ptz_ c<0~(n-1)>_ma xzoom	1/4	Zoom position at each preset location.
preset_i<0~(k-1)>_focus	capability_ptz_ c<0~(n-1)>_min focus ~ capability_ptz_ c<0~(n-1)>_ma xfocus	1/4	Focus position at each preset location.
preset_i<0~(k-1)>_ dwelling	0 ~ 999	1/4	The dwelling time of each preset location
preset_i<0~(k-1)>_focus setting	sync, fixcurrent	1/4	The focus mode of each preset, which is essential and should be grouped with "preset_i<0~(k-1)>_name." * We support this parameter when the version number (httpversion) is equal or greater than 0305b.
patrolseq	string[120]	1/4	(For external device) The indexes of patrol points, separated by ","
patroldwelling	string[160]	1/4	(For external device) The dwelling time of each patrol point, separated by ","
disablemdonptz	<boolean>	1/4	Disable motion detection on PTZ

NAME	VALUE	SECURITY (get/set)	DESCRIPTION
			operation.
defaulthome	<boolean>	1/4	This field tells system to use default home position or not.
axisz	capability_ptz_ c<0~(n-1)>_min zoom ~ capability_ptz_ c<0~(n-1)>_ma xzoom	1/4	Custom home zoom position.
axisf	capability_ptz_ c<0~(n-1)>_min focus ~ capability_ptz_ c<0~(n-1)>_ma xfocus	1/4	Custom home focus position.
digitalzoom	<boolean>	1/4	Enable/disable digital zoom
zoomenhance	<boolean>	1/4	Enable /disable zoom enhancement
returnhome	<boolean>	1/4	Enable/disable return home while idle.
returnhomeinterval	1~999	1/4	While idle over this time interval, idle action will be taken.
idleaction_enable	<boolean>	1/4	Enable/disable idle action while idle
idleaction_type	home	1/4	This field tells what kind of action should be taken while idle.
idleaction_interval	1~999	1/4	While idle over this time interval, idle action will be taken.

PLEASE REFER TO PTZ CONTROL API

7.42 Camera PTZ Control (SD Series)

Group: `camctrl_c<0~(n-1)>` for n channel products (the bit7 of `capability_ptzenabled` is 0 and the bit4 of `capability_ptzenabled` is 1)

n denotes the value of "capability_nvideoin" and k denotes the value of "capability_npreset"

NAME	VALUE	SECURITY (get/set)	DESCRIPTION
<code>ccdtype</code>	string[16]	6/7	(Internal used, read only)
<code>motortype</code>	string[16]	6/7	(Internal used, read only)
<code>cameraid</code>	1 ~ 255	1/4	<p>Camera ID controlling external PTZ camera.</p> <p>Note:</p> <p>Please set your speed dome to the appropriate baud rate, and Camera ID, e.g. 2400bps, camera ID 1,2,3,,,,etc.</p> <p>All Camera IDs on the same controlling system (NVR or rs485 keyboard) have to be distinct. Therefore, once you send a controlling signal, each camera will only accept the inputs with the corresponding ID.</p>
<code>panspeed</code>	-5 ~ 5	1/4	Pan speed
<code>tiltspeed</code>	-5 ~ 5	1/4	Tilt speed
<code>zoomspeed</code>	-5 ~ 5	1/4	Zoom speed
<code>autospeed</code>	-5 ~ 5	1/4	Auto pan speed
<code>focusspeed</code>	-5 ~ 5	1/4	Auto focus speed
<code>focusmode</code>	auto, onetimeauto, spotlight, manual * Available values are listed in "capability_camctrl_c<0~(n-1)>_focusmode"	1/4	Indicate the focus control mode.
<code>preset_i<0~(k-1)>_name</code>	string[40]	1/4	Name of the preset location.
<code>preset_i<0~(k-1)>_pan</code>	capability_ptz_c<0~(1/4	Pan position at each preset

NAME	VALUE	SECURITY (get/set)	DESCRIPTION
	n-1)>_minpan ~ capability_ptz_c<0~(n-1)>_maxpan		location.
preset_i<0~(k-1)>_tilt	capability_ptz_c<0~(n-1)>_mintilt ~ capability_ptz_c<0~(n-1)>_maxtilt	1/4	Tilt position at each preset location.
preset_i<0~(k-1)>_zoom	capability_ptz_c<0~(n-1)>_minzoom ~ capability_ptz_c<0~(n-1)>_maxzoom	1/4	Zoom position at each preset location.
preset_i<0~(k-1)>_focus	capability_ptz_c<0~(n-1)>_minfocus ~ capability_ptz_c<0~(n-1)>_maxfocus	1/4	Focus position at each preset location.
preset_i<0~(k-1)>_focus setting	sync, fixcurrent	1/4	The focus mode of each preset, which is essential and should be grouped with "preset_i<0~(k-1)>_name." * We support this parameter when the version number (httpversion) is equal or greater than 0305b.
preset_i<0~(k-1)>_fliped	<boolean>	1/4	Flip side at each preset location.
patrol_i<0~39>_name	string[40]	1/4	(For internal device) The name of patrol location
patrol_i<0~39>_dwelling	0 ~ 999	1/4	(For internal device) The dwelling time of each patrol location
disablemdonptz	<boolean>	1/4	Disable motion detection on PTZ operation.
defaulthome	<boolean>	1/4	This field tells system to use default home position or not.
axisx	capability_ptz_c<0~(n-1)>_minpan ~ capability_ptz_c<0~(n-1)>_maxpan	1/4	Custom home pan position.

NAME	VALUE	SECURITY (get/set)	DESCRIPTION
	n-1)>_maxpan		
axisy	capability_ptz_c<0~(n-1)>_mintilt ~ capability_ptz_c<0~(n-1)>_maxtilt	1/4	Custom home tilt position.
axisz	capability_ptz_c<0~(n-1)>_minzoom ~ capability_ptz_c<0~(n-1)>_maxzoom	1/4	Custom home zoom position.
axisf	capability_ptz_c<0~(n-1)>_minfocus ~ capability_ptz_c<0~(n-1)>_maxfocus	1/4	Custom home focus position.
axisflip	<boolean>	1/4	Custom home flip side.
returnhome	<boolean>	1/4	Enable/disable return home while idle.
returnhomeinterval	1~999	1/4	While idle over this time interval, idle action will be taken.
digitalzoom	<boolean>	1/4	Enable/disable digital zoom
idleaction_enable	<boolean>	1/4	Enable/disable idle action while idle
idleaction_type	pan,patrol,tour,home ,objtrack,prev	1/4	This field tells what kind of action should be taken while idle.
idleaction_interval	1~999	1/4	While idle over this time interval, idle action will be taken.
zoomenhance	<boolean>	1/4	Enable /disable zoom enhancement
tour_index	-1, 0~19	1/4	Index of the enabled tour group, from 0 to 19. Set -1 to disable all the tour groups.
tour_i<0~19>_name	string[40]	1/4	Name of the tour.
tour_i<0~19>_type	<boolean>	1/4	0 = Recorded tour 1 = Preset tour
tour_i<0~19>_speed	-5 ~ 5	1/4	Preset tour: pan and tilt speed when moving between presets.

NAME	VALUE	SECURITY (get/set)	DESCRIPTION
			Recorded tour: unnecessary.
tour_i<0~19>_direction	forward,backward,random	1/4	User can choose which direction the preset tour goes. "forward" : preset tour goes in forward order. "backward" : preset tour goes in backward order. "random" : the presets of the tour will be recalled randomly. * Only available when "capability_presettourdirection" is 1. * We support this parameter when the version number (httpversion) is equal or greater than 0307a.
tour_i<0~19>_checklist	string[512]	1/4	The indexes of preset positions, separated by “;”
tour_i<0~19>_dwelltime	string[512]	1/4	Preset tour: time to wait before moving to the next preset position, separated by “;” Recorded tour: number of seconds to wait before continuing a loop tour.

PLEASE REFER TO PTZ CONTROL API

7.43 UART Control

Group: **uart** (*capability_uart > 0* and *capability_fisheye = 0*)

NAME	VALUE	SECURITY (get/set)	DESCRIPTION
ptzdrivers_i<0~19, 127>_name	string[40]	1/4	Name of the PTZ driver.
ptzdrivers_i<0~19, 127>_location	string[128]	1/4	Full path of the PTZ driver.
enablehttptunnel	<boolean>	1/4	Enable HTTP tunnel channel to control UART.

Group: **uart_i<0~(n-1)>** n is uart port count (*capability_uart > 0* and *capability_fisheye = 0*)

NAME	VALUE	SECURITY (get/set)	DESCRIPTION
baudrate	300,600,1200,2400, 4800,9600,19200,38400,57600,115200	4/4	Set baud rate of COM port.
databit	5,6,7,8	4/4	Data bits in a character frame.
paritybit	none, odd, even	4/4	For error checking.
stopbit	1,2	4/4	"1": One stop bit is transmitted to indicate the end of a byte. "2": Two stop bits are transmitted to indicate the end of a byte. If you want to transfer the stopbit for 150% of the normal time used to transfer one bit, the <code>uart_i<0~(n-1)>_stopbit</code> should be set as 2 and the <code>uart_i<0~(n-1)>_databit</code> set as 5 as well.
uartmode	rs485, rs232	4/4	RS485 or RS232.
customdrvcmd_i<0~9>	string[128]	1/4	PTZ command for custom camera.

NAME	VALUE	SECURITY (get/set)	DESCRIPTION
speedlink_i<0~4>_name	string[40]	1/4	Additional PTZ command name.
speedlink_i<0~4>_cmd	string[40]	1/4	Additional PTZ command list.
ptzdriver	0~19, 127 (custom), 128 (no driver)	1/4	The PTZ driver is used by this COM port.

7.44 UART Control (SD Series)

Group: `uart_i<0~(n-1)>` n is uart port count (`capability_nuart > 0` and the bit7 of `capability_ptzenabled` is 0, the bit4 of `capability_ptzenabled` is 1)

NAME	VALUE	SECURITY (get/set)	DESCRIPTION
cameraid	1~255	4/4	Camera ID controlling external PTZ camera. Note: Please set your speed dome to the appropriate baud rate, and Camera ID, e.g. 2400bps, camera ID 1,2,3,,,,etc. All Camera IDs on the same controlling system (NVR or rs485 keyboard) have to be distinct. Therefore, once you send a controlling signal, each camera will only accept the inputs with the corresponding ID.
baudrate	2400,4800,9600,19200,38400,57600,115200	4/4	Set baud rate of COM port.
databit	5,6,7,8	4/4	Data bits in a character frame.
paritybit	none, odd, even	4/4	For error checking.

NAME	VALUE	SECURITY (get/set)	DESCRIPTION
stopbit	1,2	4/4	"1": One stop bit is transmitted to indicate the end of a byte. "2": Two stop bits are transmitted to indicate the end of a byte. If you want to transfer the stopbit for 150% of the normal time used to transfer one bit, the <code>uart_i<0~(n-1)>_stopbit</code> should be set as 2 and the <code>uart_i<0~(n-1)>_databit</code> set as 5 as well.
uartmode	rs485	4/7	RS485 mode.

7.45 Lens Configuration

Group: **lens** for n channel products

n denotes the value of "capability_nvideoin"

(`capability_image_c<0~(n-1)>_lensconfiguration_support = 1`)

NAME	VALUE	SECURITY (get/set)	DESCRIPTION
selected	<string>	6/7	Current selected lens profile. e.g. <code>lens_selected=lens_default_i0</code> , it means chosen lens configuration is i0 lens of default group.

Group: **lens_default**

NAME	VALUE	SECURITY (get/set)	DESCRIPTION
totalnumbers	0,<positive integer>	6/7	Totoal support number of the default lens profiles

Group: **lens_user**

NAME	VALUE	SECURITY (get/set)	DESCRIPTION
totalnumbers	0,<positive integer>	6/7	Totoal support number of the user lens profiles

Group: **lens_default_i<0~(n-1)>**

n denotes the value of "lens_default_totalnumbers"

NAME	VALUE	SECURITY (get/set)	DESCRIPTION
name	<string>	6/7	Default lens name

Group: **lens_user_i<0~(n-1)>**

n denotes the value of "lens_user_totalnumbers"

NAME	VALUE	SECURITY (get/set)	DESCRIPTION
name	<string>	6/7	User-defined lens name

7.46 Fisheye Info.

Group: **fisheyeinfo** (*capability_fisheye > 0*)

NAME	VALUE	SECURITY (get/set)	DESCRIPTION
revisedcenteraxis	<coordinate>	6/7	The actual center axis coordinate
radius	0, <positive integer>	6/7	The actual center radius

7.47 Fisheye Local Dewarp Setting

Group: **fisheyedewarp_c<0~(n-1)>** (*capability_fisheylaldewarp_c<0~(n-1)> > 0*)

n denotes the value of "capability_nvideoin", m denotes the value of "capability_nmediastream"

NAME	VALUE	SECURITY (get/set)	DESCRIPTION
panspeed	-5 ~ 5 <integer>	1/4	Pan speed of regional view
tiltspeed	-5 ~ 5 <integer>	1/4	Tilt speed of regional view
zoomspeed	-5 ~ 5 <integer>	1/4	Zoom speed of regional
s<0~(m-2)>_panora ma_panstart	0~359 <integer>	1/4	Initial pan position of panorama view. (only available for 1P and 2P mode at ceiling or floor mount)
s<0~(m-2)>_region_ pan	-90~359 <integer>	1/4	Pan home angle of regional view Pan range of ceiling/floor mount is

NAME	VALUE	SECURITY (get/set)	DESCRIPTION
			[0~359]. Pan range of wall mount is [-90~90].
s<0~(m-2)>_region_tilt	-90~90 <integer>	1/4	Tilt home angle of regional view Tilt range of ceiling/floor mount is [0~90]. Tilt range of wall mount is [-90~90].
s<0~(m-2)>_region_zoom	100~300 <integer>	1/4	Zoom home ratio of regional view

[PLEASE REFER TO FISHEYE LOCAL DEWARP API](#)

7.48 PIR Behavior Define

Group: **pir** (*capability_npir > 0*)

NAME	VALUE	SECURITY (get/set)	DESCRIPTION
enable	<boolean>	1/1	Enable/disable PIR

7.49 Auto Tracking Setting

Group: **autotrack_c<0~(n-1)>** (*capability_image_c<0~(n-1)>_autotrack_support > 0*)

n denotes the value of "capability_nvideoin"

PARAMETER	VALUE	SECURITY (get/set)	DESCRIPTION
objsize_type	-1~2	1/4	Type of object size. -1 : customized width and height 0 : object size = 30 x 30 1 : object size = 10 x 20 2 : object size = 10 x 10
objsize_customized_width	10~320	1/4	The minimum width of tracking target.
objsize_customized_height	10~240	1/4	The minimum height of tracking target.
sensitivity	0~2	1/4	Tracking sensitivity. 0: Low 1: Medium 2: High

7.50 Wireless

Group: **wireless** (`capability_network_wireless > 0`)

PARAMETER	VALUE	SECURITY (get/set)	DESCRIPTION
ssid	string[32]	6/6	SSID for wireless lan settings.
wlmode	Infra, Adhoc	6/6	Wireless mode. Infra: Infrastructure
channel	1~11 or 1~13 or 10~11 or 10~13 or 1~14	6/6	A list of WLAN channels. Countries apply their own regulations to the allowable channels. 1~11: USA and Canada 1~13: Europe 10~11: Spain 10~13: France 1~14: Japan * Only valid when "wireless_wlmode" is "Adhoc"
encrypt	none, wep, wpa, wpa2	6/6	Encryption method: none: NONE, wep: WEP, wpa: WPA, wpa2: WPA2PSK
authmode	OPEN, SHARED	6/6	Authentication mode. * Only valid when "wireless_encrypt" is "wep"
keylength	64, 128	6/6	Key length in bits. * Only valid when "wireless_encrypt" is "wep"
keyformat	HEX, ASCII	6/6	Key1 ~ key4 presentation format. * Only valid when "wireless_encrypt" is "wep"
keyselect	1 ~ 4	6/6	Default key number. * Only valid when "wireless_encrypt" is "wep"

PARAMETER	VALUE	SECURITY (get/set)	DESCRIPTION
key1	password [26]	6/6	WEP key1 for encryption. * Only valid when "wireless_encrypt" is "wep"
key2	password [26]	6/6	WEP key2 for encryption. * Only valid when "wireless_encrypt" is "wep"
key3	password [26]	6/6	WEP key3 for encryption. * Only valid when "wireless_encrypt" is "wep"
key4	password [26]	6/6	WEP key4 for encryption. * Only valid when "wireless_encrypt" is "wep"
algorithm	AES, TKIP	6/6	Algorithm * Only valid when "wireless_encrypt" is "wpa" or "wpa2"
presharedkey	password [64]	6/6	WPA/WPA2PSK mode pre-shared key. * Only valid when "wireless_encrypt" is "wpa" or "wpa2"

7.51 Shock Detection

Group: **shock_c<0~(n-1)>** for n channel products

n denotes the value of "capability_nvideoin" (**capability_shockalarm_support > 0**)

PARAMETER	VALUE	SECURITY (get/set)	DESCRIPTION
alarm_enable	<boolean>	4/4	Enable shock detection's alarm.
alarm_level	1~100	4/4	The value indicate the support strength level of shock detection's alarm.

8. Useful Functions

8.1 Drive the Digital Output (**capability_ndo > 0**)

Note: This request requires Viewer privileges.

Method: GET/POST

Syntax:

```
http://<servername>/cgi-bin/dido/setdo.cgi?do1=<state>[&do2=<state>]
[&do3=<state>][&do4=<state>]
```

Where state is 0 or 1; "0" means inactive or normal state, while "1" means active or triggered state.

PARAMETER	VALUE	DESCRIPTION
do<num>	0, 1	0 – Inactive, normal state
		1 – Active, triggered state

Example: Drive the digital output 1 to triggered state and redirect to an empty page.

```
http://myserver/cgi-bin/dido/setdo.cgi?do1=1
```

8.2 Query Status of the Digital Input (**capability_nde > 0**)

Note: This request requires Viewer privileges

Method: GET/POST

Syntax:

```
http://<servername>/cgi-bin/dido/getdi.cgi?[di0][&di1][&di2][&di3]
```

If no parameter is specified, all of the digital input statuses will be returned.

Return:

```
HTTP/1.0 200 OK\r\n
Content-Type: text/plain\r\n
Content-Length: <length>\r\n
\r\n
[di0=<state>]\r\n
[di1=<state>]\r\n
[di2=<state>]\r\n
```

```
[di3=<state>]\r\n
```

where <state> can be 0 or 1.

Example: Query the status of digital input 1 .

Request:

```
http://myserver/cgi-bin/dido/getdi.cgi?di1
```

Response:

```
HTTP/1.0 200 OK\r\n
```

```
Content-Type: text/plain\r\n
```

```
Content-Length: 7\r\n
```

```
\r\n
```

```
di1=1\r\n
```

8.3 Query Status of the Digital Output (**capability_ndo > 0**)

Note: This request requires Viewer privileges

Method: GET/POST

Syntax:

```
http://<servername>/cgi-bin/dido/getdo.cgi?[do0][&do1][&do2][&do3]
```

If no parameter is specified, all the digital output statuses will be returned.

Return:

```
HTTP/1.0 200 OK\r\n
```

```
Content-Type: text/plain\r\n
```

```
Content-Length: <length>\r\n
```

```
\r\n
```

```
[do0=<state>]\r\n
```

```
[do1=<state>]\r\n
```

```
[do2=<state>]\r\n
```

```
[do3=<state>]\r\n
```

where <state> can be 0 or 1.

Example: Query the status of digital output 1.

Request:

```
http://myserver/cgi-bin/dido/getdo.cgi?do1
```

Response:

```
HTTP/1.0 200 OK\r\n
Content-Type: text/plain\r\n
Content-Length: 7\r\n
\r\n
do1=1\r\n
```

8.4 Capture Single Snapshot

Note: This request requires Normal User privileges.

Method: GET/POST

Syntax:

```
http://<servername>/cgi-bin/viewer/video.jpg?[channel=<value>][&resolution=<value>]
[&quality=<value>][&streamid=<value>]
```

If the user requests a size larger than all stream settings on the server, this request will fail.

PARAMETER	VALUE	DESCRIPTION
channel	0~(capability_nvideoin -1)	The channel number of the video source.
resolution	Available options are list in "capability_videoin_c<0~(n-1)>_resolution". Besides, available options is referred to "capability_videoin_c<0~(n-1)>_maxresolution" and "capability_videoin_c<0~(n-1)>_minresolution"	The resolution of the image.
quality	1~5	The quality of the image.
streamid	0~(capability_nmediastream -1)	The stream number.

The server will return the most up-to-date snapshot of the selected channel and stream in JPEG format. The size and quality of the image will be set according to the video settings on the server.

Return:

```
HTTP/1.0 200 OK\r\n
Content-Type: image/jpeg\r\n
[Content-Length: <image size>\r\n]
<binary JPEG image data>
```

8.5 Account Management

Note: This request requires Administrator privileges.

Method: POST

Syntax:

```
http://<servername>/cgi-bin/admin/editaccount.cgi?
method=<value>&username=<name>[&userpass=<value>][&privilege=<value>]
[&privilege=<value>][&return=<return page>]
```

PARAMETER	VALUE	DESCRIPTION
method	add	Add an account to the server. When using this method, the "username" field is necessary. It will use the default value of other fields if not specified.
	delete	Remove an account from the server. When using this method, the "username" field is necessary, and others are ignored.
	edit	Modify the account password and privilege. When using this method, the "username" field is necessary, and other fields are optional. If not specified, it will keep the original settings.
username	<name>	The name of the user to add, delete, or edit.
userpass	<value>	The password of the new user to add or that of the old user to modify. The default value is an empty string.
privilege	view	The privilege of the user to add or to modify.
	operator	" view ": Viewer privilege.
	admin	" operator ": Operator privilege. " admin ": Administrator privilege.
return	<return page>	Redirect to the page <return page> after the parameter is assigned. The <return page> should be the relative path according to the root of camera. If you omit this parameter, it will redirect to an empty page. * If the <return page> is invalid path, it will ignore this parameter.

8.6 System Log

Note: This request require Administrator privileges.

Method: GET/POST

Syntax:

```
http://<servername>/cgi-bin/admin/syslog.cgi
```

Server will return the most up-to-date system log.

Return:

```
HTTP/1.0 200 OK\r\n
Content-Type: text/plain\r\n
Content-Length: <syslog length>\r\n
\r\n
<system log information>\r\n
```

8.7 Upgrade Firmware

Note: This request requires Administrator privileges.

Method: POST

Syntax:

```
http://<servername>/cgi-bin/admin/upgrade.cgi
```

Post data:

```
fimage=<file name>[&return=<return page>]\r\n
\r\n
<multipart encoded form data>
```

Server will accept the file named <file name> to upgradethe firmware and return with <return page> if indicated.

8.8ePTZ Camera Control (**capability_eptz > 0 and**

Capability_fisheye = 0)

Note: This request requires camctrl privileges.

Method: GET/POST

Syntax:

```

http://<servername>/cgi-bin/camctrl/eCamCtrl.cgi?channel=<value>&stream=<value>
[&move=<value>] – Move home, up, down, left, right
[&auto=<value>] – Auto pan, patrol
[&zoom=<value>] –Zoom in, out
[&zooming=<value>&zs=<value>] –Zoom without stopping, used for joystick
[&x=<value>&y=<value>&w=<value>&h=<value>&resolution=<value>] - Zoom in, out on a specific
area
[&vx=<value>&vy=<value>&vs=<value>] – Shift without stopping, used for joystick
[&x=<value>&y=<value>&videosize=<value>&resolution=<value>&stretch=<value>] –Click on
image
(Move the center of image to the coordination (x,y) based on resolution or videosize.)
[ [&speedpan=<value>][&speedtilt=<value>][&speedzoom=<value>][&speedapp=<value>] ] – Set
speeds
[&return=<return page>]

```

Example:

```

http://myserver/cgi-bin/camctrl/eCamCtrl.cgi?channel=0&stream=0&move=right
http://myserver/cgi-bin/camctrl/eCamCtrl.cgi?channel=0&stream=1&vx=2&vy=2&vz=2
http://myserver/cgi-bin/camctrl/eCamCtrl.cgi?channel=0&stream=1&x=100&y=100&videosize=640x480&resolution=640x480&stretch=0

```

In zoom operation, there are two ways to control it, scale zoom and area zoom.

1. [Scale zoom]: contains two control method, relative movement and continuous movement

a. relative movement -

If you trigger a relative movement, it will only zoom certain ratio and stop by itself.

<http://IPAddr/cgi-bin/camctrl/eCamCtrl.cgi?stream=0&zoom=tele>

<http://IPAddr/cgi-bin/camctrl/eCamCtrl.cgi?stream=0&zoom=wide>

The zoom ratio to move by relative movement is according to the setting of speedzoom [-5~5].

<http://IPAddr/cgi-bin/camctrl/eCamCtrl.cgi?stream=0&speedzoom=5>

b. continuous movement -

If you trigger a continuous movement, you have to handle the stop time by yourself.

A continuous movement is convenient to integrate a joystick control.

<http://IPAddr/cgi-bin/camctrl/eCamCtrl.cgi?stream=0&zooming=tele&zs=1>

<http://IPAddr/cgi-bin/camctrl/eCamCtrl.cgi?stream=0&zooming=wide&zs=5>

zooming is used to indicate the moving direction, and zs is used to indicate the speed.

To stop a continuous movement, you have to use the command as below:

<http://IPAddr/cgi-bin/camctrl/eCamCtrl.cgi?stream=0&zoom=stop&zs=0>

2. [Area zoom]: it means to zoom in on a specific area, here is an example for a directly moving [x, y] is the desired coordinate, and it will be the center after movement

[w, h] is the scaled area size

[resolution] is the base range of this coordinate system

The example shows [w, h] = [864, 488], which means to zoom in to ratio x2.2 based on [1920x1080].

Pay attention to that [x, y, w, h] are essential parameters in an area zoom case, and the stream index is counted from 0 as the first stream.

<http://IPAddr/cgi-bin/camctrl/eCamCtrl.cgi?channel=0&stream=0&x=912&y=297&w=864&h=488&resolution=1920x1080>

PARAMETER	VALUE	DESCRIPTION
channel	<0~(n-1)>	Channel of video source.
stream	<0~(m-1)>	Stream.
move	home	Move to home ROI.
	up	Move up.
	down	Move down.
	left	Move left.
	right	Move right.
auto	pan	Auto pan.
	patrol	Auto patrol.
	stop	Stop auto pan/patrol.
zoom	wide	Zoom larger view with current speed.
	tele	Zoom further with current speed.
zooming	wide or tele	Zoom without stopping for larger view or further view with zs speed, used for joystick control.
zs	0 ~ 6	Set the speed of zooming, "0" means stop.
x	<integer>	The desired coordinate, and it will be the center after

PARAMETER	VALUE	DESCRIPTION
y	<integer>	movement
w	<integer>	The scaled area size
h	<integer>	
resolution	<window size>	The resolution of streaming.
vx	<integer>	The direction of movement, used for joystick control.
vy	<integer>	
vs	0 ~ 7	Set the speed of movement, "0" means stop.
x	<integer>	x-coordinate clicked by user. It will be the x-coordinate of center after movement.
y	<integer>	y-coordinate clicked by user. It will be the y-coordinate of center after movement.
videosize	<window size>	The size of plug-in (ActiveX)window in web page
resolution	<window size>	The resolution of streaming.
stretch	<boolean>	0 indicates that it uses resolution (streaming size) as the range of the coordinate system. 1 indicates that it uses videosize (plug-in size) as the range of the coordinate system.
speedpan	-5 ~ 5	Set the pan speed.
speedtilt	-5 ~ 5	Set the tilt speed.
speedzoom	-5 ~ 5	Set the zoom speed.
speedapp	1 ~ 5	Set the auto pan/patrol speed.
return	<return page>	Redirect to the page <return page> after the parameter is assigned. The <return page> should be the relative path according to the root of camera. If you omit this parameter, it will redirect to an empty page. * If the <return page> is invalid path, it will ignore this parameter.

8.9 ePTZ Recall (**capability_eptz > 0 and capability_fisheye = 0**)

Note: This request requires camctrl privileges.

Method: GET/POST

Syntax:

```
http://<servername>/cgi-bin/camctrl/eRecall.cgi?channel=<value>&stream=<value>&recall=<value>[&return=<return page>]
```

PARAMETER	VALUE	DESCRIPTION
channel	<0~(n-1)>	Channel of the video source.
stream	<0~(m-1)>	Stream.
recall	Text string less than 40 characters	One of the present positions to recall.
return	<return page>	Redirect to the page <return page> after the parameter is assigned. The <return page> should be the relative path according to the root of camera. If you omit this parameter, it will redirect to an empty page. * If the <return page> is invalid path, it will ignore this parameter.

8.10 ePTZ Preset Locations (**capability_eptz > 0 and capability_fisheye = 0**)

Note: This request requires Operator privileges.

Method: GET/POST

Syntax:

```
http://<servername>/cgi-bin/operator/ePreset.cgi?channel=<value>&stream=<value>[&addpos=<value>][&delpos=<value>][&return=<return page>]
```

PARAMETER	VALUE	DESCRIPTION
channel	<0~(n-1)>	Channel of the video source.
stream	<0~(m-1)>	Stream.

PARAMETER	VALUE	DESCRIPTION
addpos	<Text string less than 40 characters>	Add one preset location to the preset list.
delpos	<Text string less than 40 characters>	Delete preset location from the preset list.
return	<return page>	Redirect to the page <return page> after the parameter is assigned. The <return page> should be the relative path according to the root of camera. If you omit this parameter, it will redirect to an empty page. * If the <return page> is invalid path, it will ignore this parameter.

8.11 IP Filtering for ONVIF

Syntax:<product dependent>

```
http://<servername>/cgi-bin/admin/ipfilter.cgi?type[=<value>]
http://<servername>/cgi-bin/admin/ipfilter.cgi?method=add<v4/v6>&ip=<ipaddress>[&index=<value>][&return=<return page>]
http://<servername>/cgi-bin/admin/ipfilter.cgi?method=del<v4/v6>&index=<value>[&return=<return page>]
```

PARAMETER	VALUE	DESCRIPTION
type	NULL	Get IP filter type
	allow, deny	Set IP filter type
method	addv4	Add IPv4 address into access list.
	addv6	Add IPv6 address into access list.
	delv4	Delete IPv4 address from access list.
	delv6	Delete IPv6 address from access list.
ip	<IP address>	Single address: <IP address> Network address: <IP address / network mask> Range address:<start IP address - end IP address>
index	<value>	The start position to add or to delete.

8.12 UART HTTP Tunnel Channel (**capability_nuart > 0**)

Note: This request requires Operator privileges.

Method: GET and POST

Syntax:

```
http://<servername>/cgi-bin/operator/uartchannel.cgi?[channel=<value>]
```

```
-----
```

```
GET /cgi-bin/operator/uartchannel.cgi?[channel=<value>]
```

```
x-sessioncookie: string[22]
```

```
accept: application/x-vvtk-tunnelled
```

```
pragma: no-cache
```

```
cache-control: no-cache
```

```
-----
```

```
POST /cgi-bin/operator/uartchannel.cgi
```

```
x-sessioncookie: string[22]
```

```
content-type: application/x-vvtk-tunnelled
```

```
pragma : no-cache
```

```
cache-control : no-cache
```

```
content-length: 32767
```

```
expires: Sun, 9 Jan 1972 00:00:00 GMT
```

User must use GET and POST to establish two channels for downstream and upstream. The x-sessioncookie in GET and POST should be the same to be recognized as a pair for one session. The contents of upstream should be base64 encoded to be able to pass through a proxy server.

This channel will help to transfer the raw data of UART over the network.

Please see UART tunnel spec for detail information

PARAMETER	VALUE	DESCRIPTION
channel	0 ~ (n-1)	The channel number of UART.

8.13 Event/Control HTTP Tunnel Channel

(capability_evctrlchannel > 0)

Note: This request requires **Administrator** privileges.

Method: GET and POST

Syntax:

```
http://<servername>/cgi-bin/admin/ctrlevent.cgi
```

```
-----  
GET /cgi-bin/admin/ctrlevent.cgi
```

```
x-sessioncookie: string[22]
```

```
accept: application/x-vvtk-tunnelled
```

```
pragma: no-cache
```

```
cache-control: no-cache
```

```
-----  
POST /cgi-bin/admin/ctrlevent.cgi
```

```
x-sessioncookie: string[22]
```

```
content-type: application/x-vvtk-tunnelled
```

```
pragma : no-cache
```

```
cache-control : no-cache
```

```
content-length: 32767
```

```
expires: Sun, 9 Jan 1972 00:00:00 GMT
```

User must use GET and POST to establish two channels for downstream and upstream. The x-sessioncookie in GET and POST should be the same to be recognized as a pair for one session. The contents of upstream should be base64 encoded to be able to pass through the proxy server.

This channel will help perform real-time event subscription and notification as well as camera control more efficiently. The event and control formats are described in another document.

See Event/control tunnel spec for detail information

8.14 Get SDP of Streams

Note: This request requires Viewer access privileges.

Method: GET/POST

Syntax:

```
http://<servername>/<network_rtsp_s<0~m-1>_accessname>
```

“m” is the stream number.

“network_accessname_<0~(m-1)>” is the accessname for stream “1” to stream “m”. Please refer to the “subgroup of network: rtsp” for setting the accessname of SDP.

You can get the SDP by HTTP GET.

When using scalable multicast, Get SDP file which contains the multicast information via HTTP.

8.15 Open the Network Stream

Note: This request requires Viewer access privileges.

Syntax:

For HTTP push server (MJPEG):

```
http://<servername>/<network_http_s<0~m-1>_accessname>
```

For RTSP (MP4), the user needs to input the URL below into an RTSP compatible player.

```
rtsp://<servername>/<network_rtsp_s<0~m-1>_accessname>
```

“m” is the stream number.

For details on streaming protocol, please refer to the “control signaling” and “data format” documents.

8.16 Send Data (**capability_nuart > 0**)

Note: This request requires Viewer privileges.

Method: GET/POST

Syntax:

```
http://<servername>/cgi-bin/viewer/senddata.cgi?
[com=<value>][&data=<value>][&flush=<value>] [&wait=<value>] [&read=<value>]
```

PARAMETER	VALUE	DESCRIPTION
com	1 ~ <max. com port number>	The target COM/RS485 port number.
data	<hex decimal data>[,<hex decimal data>]	The <hex decimal data> is a series of digits from 0 ~ 9, A ~ F. Each comma separates the commands by 200 milliseconds.
flush	yes,no	yes: Receive data buffer of the COM port will be cleared before read. no: Do not clear the receive data buffer.
wait	1 ~ 65535	Wait time in milliseconds before read data.
read	1 ~ 128	The data length in bytes to read. The read data will be in the return page.

Return:

```
HTTP/1.0 200 OK\r\n
Content-Type: text/plain\r\n
Content-Length: <system information length>\r\n
\r\n
<hex decimal data>\r\n
```

Where hexadecimal data is digits from 0 ~ 9, A ~ F.

8.17 Storage Managements (**capability_stroage.dbenabled > 0**)

Note: This request requires **administrator** privileges.

Method: GET and POST

Syntax:

```
http://<servername>/cgi-bin/admin/lctrl.cgi?cmd=<cmd_type>[&<parameter>=<value>...]
```

The commands usage and their input arguments are as follows.

PARAMETER	VALUE	DESCRIPTION
cmd_type	<string>	Required. Command to be executed, including <i>search</i> , <i>insert</i> , <i>delete</i> , <i>update</i> , and <i>queryStatus</i> .

Command: **search**

PARAMETER	VALUE	DESCRIPTION
label	<integer primary key>	Optional. The integer primary key column will automatically be assigned a unique integer.
triggerType	<text>	Optional. Indicate the event trigger type. Please embrace your input value with single quotes. Ex. <i>mediaType='motion'</i> Support trigger types are product dependent.
mediaType	<text>	Optional. Indicate the file media type. Please embrace your input value with single quotes. Ex. <i>mediaType='videoclip'</i> Support trigger types are product dependent.
destPath	<text>	Optional. Indicate the file location in camera. Please embrace your input value with single quotes. Ex. <i>destPath ='/mnt/auto/CF/NCMF/abc.mp4'</i>
resolution	<text>	Optional. Indicate the media file resolution. Please embrace your input value with single quotes.

PARAMETER	VALUE	DESCRIPTION
		Ex. resolution='800x600'
isLocked	<boolean>	Optional. Indicate if the file is locked or not. 0: file is not locked. 1: file is locked. A locked file would not be removed from UI or cyclic storage.
triggerTime	<text>	Optional. Indicate the event trigger time. (not the file created time) Format is "YYYY-MM-DD HH:MM:SS" Please embrace your input value with single quotes. Ex. triggerTime='2008-01-01 00:00:00' If you want to search for a time period, please apply "TO" operation. Ex. triggerTime='2008-01-01 00:00:00'+TO+'2008-01-01 23:59:59' is to search for records from the start of Jan 1 st 2008to the end of Jan 1 st 2008.
limit	<positive integer>	Optional. Limit the maximum number of returned search records.
offset	<positive integer>	Optional. Specifies how many rows to skip at the beginning of the matched records. Note that the offset keyword is used after limit keyword.

To increase the flexibility of search command, you may use "OR" connectors for logical "OR" search operations. Moreover, to search for a specific time period, you can use "TO" connector.

Ex. To search records triggered by motion or di or sequential and also triggered between 2008-01-01 00:00:00 and 2008-01-01 23:59:59.

```
http://<servername>/cgi-bin/admin/lscrtl.cgi?cmd=search&triggerType='motion'+OR+'di'+OR+'seq'
&triggerTime='2008-01-01 00:00:00'+TO+'2008-01-01 23:59:59'
```

Command: **delete**

PARAMETER	VALUE	DESCRIPTION
label	<integer primary key>	Required. Identify the designated record.

PARAMETER	VALUE	DESCRIPTION
		Ex. label=1

Ex. Delete records whose key numbers are 1, 4, and 8.

```
http://<servername>/cgi-bin/admin/lscrtl.cgi?cmd=delete&label=1&label=4&label=8
```

Command: **update**

PARAMETER	VALUE	DESCRIPTION
label	<integer primary key>	Required. Identify the designated record. Ex. label=1
isLocked	<boolean>	Required. Indicate if the file is locked or not.

Ex. Update records whose key numbers are 1 and 5 to be locked status.

```
http://<servername>/cgi-bin/admin/lscrtl.cgi?cmd=update&isLocked=1&label=1&label=5
```

Ex. Update records whose key numbers are 2 and 3 to be unlocked status.

```
http://<servername>/cgi-bin/admin/lscrtl.cgi?cmd=update&isLocked=0&label=2&label=3
```

Command: **queryStatus**

PARAMETER	VALUE	DESCRIPTION
retType	xml or javascript	Optional. Ex. retype=javascript The default return message is in XML format.

Ex. Query local storage status and call for javascript format return message.

```
http://<servername>/cgi-bin/admin/lscrtl.cgi?cmd=queryStatus&retType=javascript
```

8.18 Virtual Input (**capability_nvi > 0**)

Note: Change virtual input (manual trigger) status.

Method: GET

Syntax:

```
http://<servername>/cgi-bin/admin/setvi.cgi?vi0=<value>[&vi1=<value>][&vi2=<value>]
[&return=<return page>]
```

PARAMETER	VALUE	DESCRIPTION
vi<num>	state[(duration)nstate] Where "state" is 0, 1. "0" means inactive or normal state while "1" means active or triggered state. Where "nstate" is next state after duration.	Ex: vi0=1 Setting virtual input 0 to trigger state
		Ex: vi0=0(200)1 Setting virtual input 0 to normal state, waiting 200 milliseconds , setting it to trigger state. Note that when the virtual input is waiting for next state, it cannot accept new requests.
return	<return page>	Redirect to the page <return page> after the parameter is assigned. The <return page> should be the relative path according to the root of camera. If you omit this parameter, it will redirect to an empty page. * If the <return page> is invalid path, it will ignore this parameter.

Return Code	Description
200	The request is successfully executed.
400	The request cannot be assigned, ex. incorrect parameters. Examples: setvi.cgi?vi0=0(10000)1(15000)0(20000)1 No multiple duration. setvi.cgi?vi3=0 VI index is out of range. setvi.cgi?vi=1 No VI index is specified.
503	The resource is unavailable, ex. Virtual input is waiting for next state.

	<p>Examples:</p> <p>setvi.cgi?vi0=0(15000)1</p> <p>setvi.cgi?vi0=1</p> <p>Request 2 will not be accepted during the execution time(15 seconds).</p>
--	---

8.19 Open Timeshift Stream (**capability_timeshift > 0, timeshift_enable=1, timeshift_c<n>_s<m>_allow=1**)

Note: This request requires Viewer access privileges.

Syntax:

For HTTP push server (MJPEG):

http://<servername>/<network_http_s<m>_accessname>?maxsft=<value>[&tsmode=<value>&reftime=<value>&forcechk&minsft=<value>]

For RTSP (MP4 and H264), the user needs to input theURL below into an RTSP compatible player.

rtsp://<servername>/<network_rtsp_s<m>_accessname>?maxsft=<value>[&tsmode=<value>&reftime=<value>&forcechk&minsft=<value>]

“n” is the channel index.

“m” is the timeshift stream index.

For details on timeshift stream, please refer to the “TimeshiftCaching” documents.

PARAMETER	VALUE	DEFAULT	DESCRIPTION
maxsft	<positive integer>	0	Request cached stream at most how many seconds ago. The value must be a positive integer. (>0)
tsmode	normal, adaptive	normal	Streaming mode: normal => Full FPS all the time. adaptive => Default send only I-frame for MP4 and H.264, and send 1 FPS for MJPEG. If DI or motion window are triggered, the streaming is changed to send full FPS for 10 seconds. (*Note: this parameter also works on non-timeshift streams.) tsmode must exactly match well-defined wording (normal, adaptive), unknown parameters are always

PARAMETER	VALUE	DEFAULT	DESCRIPTION
			ignored.
reftime	mm:ss	The time camera receives the request.	Reference time for maxsft and minsft. (This provides more precise time control to eliminate the inaccuracy due to network latency.) Ex: Request the streaming from 12:20 rtsp://10.0.0.1/live.sdp?maxsft=10&reftime=12:30
forcechk	N/A	N/A	Check if the requested stream enables timeshift, feature and if minsft is achievable. If false, return "415 Unsupported Media Type".
minsft	<positive integer>	0	How many seconds of cached stream client can accept at least. (Used by forcechk) The value must be a positive integer. (>0)

Return Code	Description
400 Bad Request	Request is rejected because some parameter values are illegal.
415 Unsupported Media Type	Returned, if forcechk appears, when minsft is not achievable or the timeshift feature of the target stream is not enabled.

8.20 RemoteFocus

(capability_image_c<0~(n-1)>_remotefocus=1)

Note: This request requires Administrator privileges.

Method: GET/POST

Syntax:

```
http://<servername>/cgi-bin/admin/remotefocus.cgi?function=<value>[&direction=<value>]  
[&position=<value>][&steps=<value>][&iris]
```

PARAMETER	VALUE	DESCRIPTION
function	zoom, focus, auto, scan, stop, positioning, irisopen, irisenable, getstatus	<p>Function type</p> <p>zoom - Move focus motor</p> <p>focus – Move focus motor</p> <p>auto – Perform auto focus</p> <p>scan – Perform focus scan</p> <p>stop – Stop current operation</p> <p>positioning – Position the motors</p> <p>irisopen – Fully open iris. It will maintain fully open iris status until sending function=irisenable cgi.</p> <p>irisenable – return back to user setting status of iris.</p> <p>getstatus–Information of motors, return value as below:</p> <p>remote_focus_zoom_motor_max: Maximum steps of zoom motor</p> <p>remote_focus_focus_motor_max: Maximum steps of focus motor</p> <p>remote_focus_zoom_motor_start: Start point of zoom motor</p> <p>remote_focus_zoom_motor_end: End point of zoom motor</p> <p>remote_focus_focus_motor_start: Start point of effective focal length</p> <p>remote_focus_focus_motor_end: End point of effective focal length</p> <p>remote_focus_zoom_motor: Current position of zoom motor</p> <p>remote_focus_focus_motor: Current position of focus motor</p> <p>remote_focus_zoom_enable: Current function of zoom motor</p> <p>remote_focus_focus_enable: Current function of focus motor</p> <p>remote_focus_iris_open: The current status of iris. 0: irisenable, 1: irisopen</p> <p>Current function of zoom/focus motor, return value as below:</p> <p>0: no service</p> <p>1: zooming</p> <p>2. focusing</p> <p>3: auto focus</p> <p>4: focus scan</p> <p>5: positioning (both zoom motor and focus motor)</p> <p>12: reset focus</p>

PARAMETER	VALUE	DESCRIPTION
direction	direct, forward, backward	Motor's moving direction. It works only if function=zoom or function=focus.
position	0~<motor_max>	Motor's position. It works only if function=zoom or function= focus and direction=direct. <motor_max> is refer to remote_focus_focus_motor_max or remote_focus_zoom_motor_max which replied from "function=getstatus"
steps	1 ~ <motor_max>	Motor's moving steps. It works only if function=zoom or function=focus and direction=forward and direction=backward. <motor_max> is refer to remote_focus_focus_motor_max or remote_focus_zoom_motor_max which replied from "function=getstatus" * This parameter is for additional fine-tune, the value is from 1 to 30.
iris	N/A	Open iris or not. It works only if function=auto or function=scan.

8.21 BackFocus (**capability_image_c<0~(n-1)>_remotefocus=4**)

Note: This request requires Administrator privileges.

Method: GET/POST

Syntax:

```
http://<servername>/cgi-bin/admin/remotefocus.cgi?function=<value>[&direction=<value>]  
[&position=<value>][&steps=<value>][&iris]
```

PARAMETER	VALUE	DESCRIPTION
-----------	-------	-------------

PARAMETER	VALUE	DESCRIPTION
function	focus, auto, scan, stop, positioning, irisopen, irisenable, resetfocus, getstatus	<p>Function type</p> <p>focus – Move focus motor</p> <p>auto – Perform auto focus</p> <p>scan – Perform focus scan</p> <p>stop – Stop current operation</p> <p>positioning – Position the motors</p> <p>resetfocus – reset focus position to default</p> <p>irisopen – Fully open iris. It will maintain fully open iris status until sending function=irisenable cgi.</p> <p>irisenable – return back to user setting status of iris.</p> <p>getstatus–Information of motors, return value as below:</p> <p>remote_focus_focus_motor_max: Maximum steps of focus motor</p> <p>remote_focus_focus_motor_start: Start point of effective focal length</p> <p>remote_focus_focus_motor_end: End point of effective focal length</p> <p>remote_focus_focus_motor: Current position of focus motor</p> <p>remote_focus_focus_enable: Current function of focus motor</p> <p>remote_focus_iris_open: The current status of iris. 0: irisenable, 1: irisopen</p> <p>Current function of zoom/focus motor, return value as below:</p> <p>0: no service</p> <p>1: zooming</p> <p>2. focusing</p> <p>3: auto focus</p> <p>4: focus scan</p> <p>5: positioning (both zoom motor and focus motor)</p> <p>12: reset focus</p>
direction	direct, forward, backward	<p>Motor’s moving direction.</p> <p>It works only if function= focus.</p>

PARAMETER	VALUE	DESCRIPTION
position	0~<motor_max>	Motor's position. It works only if function=focus and direction=direct. <motor_max> is refer to remote_focus_focus_motor_max which replied from "function=getstatus"
steps	1 ~ <motor_max>	Motor's moving steps. It works only if function=focus and direction=forward or direction=backward. <motor_max> is refer to remote_focus_focus_motor_max which replied from "function=getstatus" * This parameter is for additional fine-tune, the value is from 1 to 30.
iris	N/A	Open iris or not. It works only if function=auto or function=scan.

8.22 Export Files

Note: This request requires Administrator privileges.

Method: GET

Syntax:

For daylight saving time configuration file:

```
http://<servername>/cgi-bin/admin/exportDst.cgi
```

For language file:

```
http://<servername>/cgi-bin/admin/export_language.cgi?currentlanguage=<value>
```

PARAMETER	VALUE	DESCRIPTION
currentlanguage	0~20	Available language lists. Please refer to: system_info_language_i0 ~ system_info_language_i19.

For setting backup file:

```
http://<servername>/cgi-bin/admin/export_backup.cgi?backup
```

8.23 Upload Files

Note: This request requires Administrator privileges.

Method: POST

Syntax:

For daylight saving time configuration file:

```
http://<servername>/cgi-bin/admin/upload_dst.cgi
```

Post data:

```
filename =<file name>\r\n\r\n<multipart encoded form data>
```

For language file:

```
http://<servername>/cgi-bin/admin/upload_lan.cgi
```

Post data:

```
filename =<file name>\r\n\r\n<multipart encoded form data>
```

For setting backup file:

```
http://<servername>/cgi-bin/admin/upload_backup.cgi
```

Post data:

```
filename =<file name>\r\n\r\n<multipart encoded form data>
```

Server will accept the file named <file name> to upload this one to camera.

8.24 Update Lens Configuration

(capability_image_c<0~(n-1)>_lensconfiguration_support > 0)

Note: This request requires Administrator privileges.

Method: GET

Syntax:

For list a name of lens currently used:

```
http://<servername>/cgi-bin/admin/update_lens.cgi?get_currentlens
```

For list all names of lens installed in camera:

```
http://<servername>/cgi-bin/admin/update_lens.cgi?list_lens
```

For choose selected lens configuration:

```
http://<servername>/cgi-bin/admin/update_lens.cgi?choose_lens=<value>
```

You need to reboot manually after you choose another lens configuration.

For choose selected lens configuration and reboot camera:

```
http://<servername>/cgi-bin/admin/update_lens.cgi?choose_reboot_lens=<value>
```

The camera will reboot after using this cgi.

For delete selected lens configuration:

```
http://<servername>/cgi-bin/admin/update_lens.cgi?delete_lens=<value>
```

PARAMETER	VALUE	DESCRIPTION
value	<string>	Available lens name. Please refer to: lens_default_i<0~(n-1)>_name lens_user_i<0~(n-1)>_name n is a positive integer.

Method: POST

Syntax:

For upload user-defined lens configuration:

```
http://<servername>/cgi-bin/admin/update_lens.cgi?upload_lens
```

Post data:

```
upload_lens_profile_input = <file name>\r\n
\r\n
<multipart encoded form data>
```

Server will accept the file named <file name> to upload the lens profile to camera.

8.25 Media on Demand (**capability_localstorage.modnum > 0**)

Media on demand allows users to select and receive/watch/listen to metadata/video/audio contents on demand.

Note: This request requires Viewer access privileges.

Syntax:

```
rtsp://<servername>/mod.sdp? [&stime=<value>] [&etime=<value>] [&length =<value>] [&loctime =<value>] [&file=<value>] [&tsmode=<value>]
```

PARAMETER	VALUE	DEFAULT	DESCRIPTION
stime	<YYYYMMDD_HHMMSS.MMM>	N/A	Start time.
etime	<YYYYMMDD_HHMMSS.MMM>	N/A	End time.
length	<positive integer>	N/A	The length of media of interest. The unit is second.
loctime	<boolean>	0	Specify if start/end time is local time format. 1 for local time, 0 for UTC+0
file	<string>	N/A	The media file to be played.
tsmode	<positive integer>	N/A	Timeshift mode, the unit is second.

Ex.

stime	etime	length	file	Description
V	V	X	X	Play recordings between stime and etime rtsp://10.10.1.2/mod.sdp?stime=20110312_040400.000&etime=2011_0312_040510.000
V	X	V	X	Play recordings for length seconds which start from stime rtsp://10.10.1.2/mod.sdp?stime=20110312_040400.000&length=120
X	V	V	X	Play recordings for length seconds which ends at etime

				rtsp://10.10.1.2/mod.sdp?etime=20110312_040400.000&length=120
X	X	X	V	Play file file
				rtsp://10.10.1.2/mod.sdp?filename=/mnt/link0/

8.26 Fisheye Local Dewarp Camera Control (**capability_fisheye > 0 and capability_fisheye_localdewarp.c0 > 0, only support in 1R mode**)

Note: This request requires camctrl privileges.

Method: GET/POST

Syntax:

```
http://<servername>/cgi-bin/camctrl/fdCamCtrl.cgi?channel=<value>&stream=<value>
[&move=<value>] – Move home, up, down, left, right
[&zoom=<value>] – Zoom wide, tele
[[&speedpan=<value>][&speedtilt=<value>][&speedzoom=<value>]] – Set speeds
[&zooming=<value>&zs=<value>] – Zoom without stopping, used for joystick
[&vx=<value>&vy=<value>&vs=<value>] – Shift without stopping, used for joystick
[&x=<value>&y=<value>&videosize=<value>&resolution=<value>&stretch=<value>] – Click on
image (Move the center of image to the coordination (x,y) based on resolution or videosize of 10
mode.)
[&return=<return page>]
```

Example:

```
http://myserver/cgi-bin/camctrl/fdCamCtrl.cgi?channel=0&stream=0&move=right
http://myserver/cgi-bin/camctrl/fdCamCtrl.cgi?channel=0&stream=0&zoom=tele
http://myserver/cgi-bin/camctrl/fdCamCtrl.cgi?channel=0&stream=0&move=top&speedtilt=-1
http://myserver/cgi-bin/camctrl/fdCamCtrl.cgi?channel=0&stream=0&zooming=tele&zs=2
http://myserver/cgi-bin/camctrl/fdCamCtrl.cgi?channel=0&stream=0&vx=5&vy=3&vs=2
http://myserver/cgi-bin/camctrl/fdCamCtrl.cgi?channel=0&stream=0&x=700&y=700&videosize=19
20x1920&resolution=1920x1920&stretch=1
```

PARAMETER	VALUE	DESCRIPTION
channel	<0~(n-1)>	Channel of video source.
stream	<0~(m-1)>	Stream.
move	home	Move to home position.
	up	Move up.
	down	Move down.

PARAMETER	VALUE	DESCRIPTION
	left	Move left.
	right	Move right.
zoom	wide	Zoom larger view with current speed.
	tele	Zoom further with current speed.
speedpan	-5 ~ 5	Set the pan speed of current command.
speedtilt	-5 ~ 5	Set the tilt speed of current command.
speedzoom	-5 ~ 5	Set the zoom speed of current command.
zooming	wide or tele	Zoom without stopping for larger view or further view with zs speed, used for joystick control.
zs	0 ~ 6	Set the speed of zooming, "0" means stop.
vx	-6 ~ 6	The direction of movement, used for joystick control.
vy	-6 ~ 6	
vs	0 ~ 7	Set the speed of movement, "0" means stop.
x	<integer>	x-coordinate clicked by user. It will be the x-coordinate of center after movement.
y	<integer>	y-coordinate clicked by user. It will be the y-coordinate of center after movement.
videosize	<window size>	The size of plug-in (ActiveX) window in web page of 10 content.
resolution	<window size>	The resolution of streaming of 10 content.
stretch	<boolean>	0 indicates that it uses resolution (streaming size) as the range of the coordinate system. 1 indicates that it uses videosize (plug-in size) as the range of the coordinate system.
return	<return page>	Redirect to the page <return page> after the parameter is assigned. The <return page> should be the relative path according to the root of camera. If you omit this parameter, it will redirect to an empty page. * If the <return page> is invalid path, it will ignore this parameter.

PLEASE REFER TO FISHEYE LOCAL DEWARP API

8.27 3D Privacy Mask

(Capability_image_c<0~(n-1)>_privacymask_wintype = 3Drectangle)

n denotes the value of "capability_nvideoin"

Note: This request requires admin user privilege

Method: GET/POST

Syntax:

http://<servername>/cgi-bin/admin/setpm3d.cgi?method=<value>&maskname=<value>&[maskheight=<value>&maskwidth=<value>&videosize=<value>&return=<return page>]

PARAMETER	VALUE	DESCRIPTION
method	add	Add a 3D privacy mask at current location
	delete	Delete a 3D privacy mask
	edit	Edit a 3D privacy mask
maskname	string[40]	3D privacy mask name
maskheight	integer	3D privacy mask height
maskwidth	integer	3D privacy mask width
videosize	<window size>	Optimal. The size of plug-in (ActiveX) window in web page is the size of the privacy window size. This field is not necessary, it will use the default value if not specified. 320x180 for 16:9 resolution and 320x240 for 4:3 resolution.
return	<return page>	Redirect to the page <return page> after the parameter is assigned. The <return page> should be the relative path according to the root of camera. If you omit this parameter, it will redirect to an empty page. * If the <return page> is invalid path, it will ignore this parameter.

8.28 Camera Control

(capability_camctrl_c<0~(n-1)>_zoommodule = 1)

Note: This request requires Viewer privileges.

Method: GET/POST

Syntax: **(for control API)**

```

http://<servername>/cgi-bin/camctrl/camctrl.cgi?[channel=<value>][&camid=<value>]
[&move=<value>] – Move home, up, down, left, right
[&focus=<value>] – Focus operation
[&zoom=<value>] – Zoom in, out
[&zooming=<value>&zs=<value>] – Zoom without stopping, used for joystick
[&vx=<value>&vy=<value>&vs=<value>] – Shift without stopping, used for joystick
[&x=<value>&y=<value>&videosize=<value>&resolution=<value>&stretch=<value>] – Click on
image
(Move the center of image to the coordination (x,y) based on resolution or videosize.)
[ [&speedpan=<value>][&speedtilt=<value>][&speedzoom=<value>][&speedapp=<value>][&speedl
ink=<value>] ] – Set speeds
[&return=<return page>]

```

Example:

```

http://myserver/cgi-bin/camctrl/camctrl.cgi?channel=0&camid=1&move=right
http://myserver/cgi-bin/camctrl/camctrl.cgi?channel=0&camid=1&zoom=tele
http://myserver/cgi-bin/camctrl/camctrl.cgi?channel=0&camid=1&x=300&y=200&resolution=704x480&videosize=704x480&stretch=1

```

Example: (set the ptz preset with focus mode)

* We support this function when the version number of the PTZ control module is equal or greater than 5.0.0.20.

```

http://myserver/cgi-bin/camctrl/camctrl.cgi?name=xxx&focussetting=sync&cam=getsetpreset

```

PARAMETER	VALUE	DESCRIPTION
channel	<0~(n-1)>	Channel of video source.
camid	0,<positive integer>	Camera ID.
move	home	Move to camera to home position.
	up	Move camera up.

PARAMETER	VALUE	DESCRIPTION
	down	Move camera down.
	left	Move camera left.
	right	Move camera right.
speedpan	-5 ~ 5	Set the pan speed.
speedtilt	-5 ~ 5	Set the tilt speed.
speedzoom	-5 ~ 5	Set the zoom speed.
speedfocus	-5 ~ 5	Set the focus speed.
speedapp	-5 ~ 5	Set the auto pan/patrol speed.
auto	pan	Auto pan.
	patrol	Auto patrol.
	stop	Stop camera.
zoom	wide	Zoom larger view with current speed.
	tele	Zoom further with current speed.
	stop	Stop zoom.
zooming	wide or tele	Zoom without stopping for larger view or further view with zs speed, used for joystick control.
zs	0 ~ 8 <SD8362>	Set the speed of zooming, "0" means stop.
vx	<integer , excluding 0>	The slope of movement = v_y/v_x , used for joystick control.
vy	<integer>	
vs	0 ~ 127	Set the speed of movement, "0" means stop.
x	<integer>	x-coordinate clicked by user. It will be the x-coordinate of center after movement.
y	<integer>	y-coordinate clicked by user. It will be the y-coordinate of center after movement.
videosize	<window size>	The size of plug-in (ActiveX) window in web page
resolution	<window size>	The resolution of streaming.
stretch	<boolean>	0 indicates that it uses resolution (streaming size) as the range of the coordinate system. 1 indicates that it uses videosize (plug-in size) as the range of the coordinate system.

PARAMETER	VALUE	DESCRIPTION
focus	auto	Auto focus.
	far	Focus on further distance.
	near	Focus on closer distance.
focussetting	sync	Applies the selected focus mode in camctrl_c<0~(n-1)>_focusmode to this preset.
	fixcurrent	Applies the current focus position to this preset.
	* We support this function when the version number of the PTZ control module is equal or greater than 5.0.0.20.	
cam	getsetpreset	<p>Adds a named preset at current position, and return the preset index.</p> <p>* We support this function when the version number of the PTZ control module is equal or greater than 5.0.0.20.</p>

Syntax: **(for querying API)**

```
http://<servername>/cgi-bin/camctrl/camctrl.cgi? [<parameter>] [&<parameter>...]
```

Example:

<http://myserver/cgi-bin/camctrl/camctrl.cgi?getpan>

Response:

HTTP/1.0 200 OK\r\n

Cache-control: no-cache\r\n

Pragma: no-cache\r\n

\r\n

pan=4117\r\n

PARAMETER	VALUE	DESCRIPTION
getversion	<string>	Get the version of the PTZ control module.
getaction	idle, autopan, tracking, tour, patrol,	<p>Get the current status of the camera.</p> <p>* We support this parameter when the version number (getversion) is equal or greater than 5.0.0.12</p>
getpan	0, <positive integer>	<p>Get the current pan position.</p> <p>*Only available when bit0 of "capability_camctrl_c<0~(n-1)>_buildinpt" is "1"</p>

PARAMETER	VALUE	DESCRIPTION
getpanangle	<integer>	Get the current pan angle. *Only available when bit0 of "capability_camctrl_c<0~(n-1)>_buildinpt" is "1"
gettilt	0, <positive integer>	Get the current tilt position. *Only available when bit1 of "capability_camctrl_c<0~(n-1)>_buildinpt" is "1"
gettiltangle	<integer>	Get the current tilt angle. *Only available when bit1 of "capability_camctrl_c<0~(n-1)>_buildinpt" is "1"
getzoom	0, <positive integer>	Get the current zoom position.
getratio	<decimal>	Get the current zoom ratio.
getfocus	0, <positive integer>	Get the current focus position.
getminspeedlv	0, <positive integer>	Get the minimum speed level of the PTZ control. Normally, the speed level is '0,' which denotes halting a continuous movement.
getmaxptspeedlv	0, <positive integer>	Get the maximum speed level of pan/tilt moving. *Only available when "capability_camctrl_c<0~(n-1)>_buildinpt" > 0
getmaxzspeedlv	0, <positive integer>	Get the maximum speed level of zoom moving.
getmaxfspeedlv	0, <positive integer>	Get the maximum speed level of focus moving.
getminpan	0, <positive integer>	Get the lower limit for pan position. *Only available when bit0 of "capability_camctrl_c<0~(n-1)>_buildinpt" is "1"
getmaxpan	0, <positive integer>	Get the upper limit for pan position. *Only available when bit0 of "capability_camctrl_c<0~(n-1)>_buildinpt" is "1"
getminpanangle	<integer>	Get the lower limit for pan angle. *Only available when bit0 of "capability_camctrl_c<0~(n-1)>_buildinpt" is "1"
getmaxpanangle	<integer>	Get the upper limit for pan angle. *Only available when bit0 of "capability_camctrl_c<0~(n-1)>_buildinpt" is "1"
getmintilt	0, <positive integer>	Get the lower limit for tilt position. *Only available when bit1 of "capability_camctrl_c<0~(n-1)>_buildinpt" is "1"
getmaxtilt	0, <positive integer>	Get the upper limit for tilt position. *Only available when bit1 of

PARAMETER	VALUE	DESCRIPTION
		"capability_camctrl_c<0~(n-1)>_buildinpt" is "1"
getmintiltangle	<integer>	Get the lower limit for tilt angle. *Only available when bit1 of "capability_camctrl_c<0~(n-1)>_buildinpt" is "1"
getmaxtiltangle	<integer>	Get the upper limit for tilt angle. *Only available when bit1 of "capability_camctrl_c<0~(n-1)>_buildinpt" is "1"
getminzoom	0, <positive integer>	Get the lower limit for zoom position.
getmaxzoom	0, <positive integer>	Get the upper limit for zoom position.
getmaxdzoom	0, <positive integer>	Get the upper limit for digital zoom position.
getmaxratio	<decimal>	Get the maximum ratio of optical zoom. * We support this parameter when the version number (getversion) is equal or greater than 5.0.0.14
getmaxdratio	<decimal>	Get the maximum ratio of digital zoom. * We support this parameter when the version number (getversion) is equal or greater than 5.0.0.14
getminfocus	0, <positive integer>	Get the lower limit for focus position.
getmaxfocus	0, <positive integer>	Get the upper limit for focus position.

8.29 Recall (**capability_camctrl_c<0~(n-1)>_zoommodule = 1**)

Note: This request requires Viewer privileges.

Method: GET

Syntax:

```
http://<servername>/cgi-bin/viewer/recall.cgi?
recall=<value>[&channel=<value>][&return=<return page>]
```

PARAMETER	VALUE	DESCRIPTION
recall	string[30]	One of the present positions to recall.
channel	0~"capability_nvideoin"-1	Channel of the video source.

8.30 Preset Locations

(capability_camctrl_c<0~(n-1)>_zoommodule = 1)

Note: This request requires Operator privileges.

Method: GET/POST

Syntax:

```
http://<servername>/cgi-bin/operator/preset.cgi?[channel=<value>]
[&addpos=<value>][&delpos=<value>][&return=<return page>]
```

PARAMETER	VALUE	DESCRIPTION
addpos	string[30]	Add one preset location to the preset list.
channel	0~"capability_nvideoin"-1	Channel of the video source.
delpos	string[30]	Delete preset location from preset list.
return	<return page>	Redirect to the page <return page> after the parameter is assigned. The <return page> should be the relative path according to the root of camera. If you omit this parameter, it will redirect to an empty page. * If the <return page> is invalid path, it will ignore this parameter.

8.31 SmartSD (**capability_localstorage_smartsd > 0**)

Note: This request requires Administrator privileges.

Method: GET/POST

Syntax:

```
http://<servername>/cgi-bin/admin/smartsd.cgi?function=<value>
```

PARAMETER	VALUE	DESCRIPTION
function	getstatus	<p>Function type</p> <p>getstauts : Information of smartSD internal status return value as below:</p> <p>smartsd_lifetime_num: Accumulated amount of data that has been written</p> <p>smartsd_lifetime_den: Card-guaranteed amount of data that can be written</p> <p>smartsd_lifetime_rate: The ratio of smartsd_lifetime_num to smartsd_lifetime_den. It means the accumulated percentage amount of flash block has been written. The range is from 0 to 100 (unit: %). The SD card is recommended to be replaced if the percentage reaches above 90%.</p> <p>smartsd_spare_block_rate: Usage rate of spare blocks. It means the usage percentage of total spare block. The range is from 0 to 100 (unit: %). The SD card is recommended to be replaced if the percentage reaches above 90%.</p> <p>smartsd_data_size_per_unit: Size (in sectors) of data to be written when Life Information1 is updated.</p> <p>smartsd_num_of_sudden_power_failure: Indicates how many times power disconnection occurred during write/erase operations</p> <p>smartsd_operation_mode: Enables/disables power-off detection and write error notification</p> <p>smartsd_attached: Indicate the smartSD is attached or not.</p>

8.32 Connect to AP (**capability_network_wireless > 0**)

Note: This request requires Administrator privileges.

Method: GET/POST

Syntax:

```
http://<servername>/cgi-bin/admin/connect_ap.cgi
```

PARAMETER	VALUE	DESCRIPTION
N/A	N/A	Apply the wireless settings and connect to AP.

8.33 Get Wireless Information (**capability_network_wireless > 0**)

Note: This request requires Administrator privileges.

Method: GET/POST

Syntax:

```
http://<servername>/cgi-bin/admin/getwirelessinfo.cgi
```

PARAMETER	VALUE	DESCRIPTION
N/A	N/A	Get wireless information. Camera will return following information. 1. Wireless channel 2. Link quality 3. Signal level 4. Noise level 5. SNR 6. TX Rate 7. RX Rate

8.34 Get Wireless Signal Strength (**capability_network_wireless > 0**)

Note: This request requires Administrator privileges.

Method: GET/POST

Syntax:

`http://<servername>/cgi-bin/admin/getwlsignalstrength.cgi`

PARAMETER	VALUE	DESCRIPTION
N/A	N/A	Get wireless signal strength.

8.35 WPS Transaction (**capability_network_wireless > 0**)

Note: This request requires Administrator privileges.

Method: GET/POST

Syntax:

```
http://<servername>/cgi-bin/admin/start_wps.cgi
```

PARAMETER	VALUE	DESCRIPTION
N/A	N/A	Start WPS transaction.

8.36 Peripheral Control (**capability_peripheral_c<0~(n-1)>_devicecontrol > 0**)

Note: This request requires Administrator privileges.

Method: GET/POST

Syntax: (**for control API**)

```
http://<servername>/cgi-bin/admin/peripheral.cgi?channel=<value>&operation=set
[&washer_mode=<value>] – Set washer mode
[&washer_status=<value>] – Set washer status
[&washer_dwelltime=<value>] – Set washer clean time
[&heater_status=<value>] – Set heater status
```

Example:

```
http://myserver/cgi-bin/admin/peripheral.cgi?channel=0&operation=set&washer\_mode=wiper&washer\_status=on
```

Response:

```
HTTP/1.0 200 OK\r\n
Cache-control: no-cache\r\n
Pragma: no-cache\r\n
\r\n
```

```
"washer_mode : OK\r\n"
"washer_status : FAIL\r\n"
```

PARAMETER	VALUE	DESCRIPTION
channel	0~"capability_nvideoin"-1	Channel of the video source.
washer_mode	wiper	Apply the wiper to the mode of washer control system. *Only available when capability_peripheral_c<0~(n-1)>_washer_support=1
	washer	Apply the washer to the mode of washer control system. *Only available when capability_peripheral_c<0~(n-1)>_washer_support=1
washer_status	on	Enable the functionality of washer control system. *Only available when capability_peripheral_c<0~(n-1)>_washer_support=1
	off	Disable the functionality of washer control system. *Only available when capability_peripheral_c<0~(n-1)>_washer_support=1
washer_dwelltime	15~999	Apply washer washer control system operation time (including the time when spraying and wiper actions take place). *Only available when capability_peripheral_c<0~(n-1)>_washer_support=1
heater_status	auto	automatic control the heater component to keep the device in a workable environment. *Only available when capability_peripheral_c<0~(n-1)>_heater_support=1
	trigger	heater component is work in force heater once.

PARAMETER	VALUE	DESCRIPTION
		*Only available when capability_peripheral_c<0~(n-1)>_heater_support=1

Syntax: **(for querying API)**

```

http://<servername>/cgi-bin/admin/peripheral.cgi?channel=<value>&operation=get
[&supportdevice] –Get support peripheral device
[&washer_supportmode] – Get washer support modes
[&washer_mode] – Get washer mode
[&washer_status] – Get washer status
[&washer_dwelltime] – Get washer clean time
[&heater_supportstatus] – Get heater support control status
[&heater_status] – Get heater status

```

Example:

http://myserver/cgi-bin/admin/peripheral.cgi?channel=0&operation=get&supportdevice&washer_status

Response:

```

HTTP/1.0 200 OK\r\n
Cache-control: no-cache\r\n
Pragma: no-cache\r\n
\r\n
supportdevice=washer,heater\r\n
washer_status=off\r\n

```

PARAMETER	VALUE	DESCRIPTION
channel	0~"capability_nvideoin"-1	Channel of the video source.
supportdevice	N/A	Get support peripheral device.
washer_supportmode	N/A	Get the support mode of washer control system, its value is the same with "capability_peripheral_c<0~(n-1)>_washer_mode". *Only available when capability_peripheral_c<0~(n-1)>_washer_support=1
washer_mode	N/A	Get the current mode of washer control system.

PARAMETER	VALUE	DESCRIPTION
		It return the value of "washer_mode" * Available values are listed in "capability_peripheral_c<0~(n-1)>_washer_mode"
washer_status	N/A	Get the current status of washer control module. The status is 'off' as default, which means the washer is stopped; and the status 'on' means the washer is running. *Only available when capability_peripheral_c<0~(n-1)>_washer_support=1
washer_dwelltime	N/A	Get the current washer clean period of washer control system. *Only available when capability_peripheral_c<0~(n-1)>_washer_support=1
heater_supportstatus	N/A	Get the support status of heater control system. *Only available when capability_peripheral_c<0~(n-1)>_heater_support=1
heater_status	N/A	Get the current heater status. Normally it will be 'auto', it means the heater device is control by internal algorithm to keep in a suitable environment; Otherwise is 'trigger', it means the heater device is force enable to heat to an internal condition.'trigger' status will be transfer to 'auto' after reach the internal condition. *Only available when capability_peripheral_c<0~(n-1)>_heater_support=1

8.37 Optimized IR control

(capability_daynight_c<0~(n-1)>_optimizedir > 0)

Note: This request requires Administrator privileges.

Method: GET/POST

Syntax:

[http://<servername>/cgi-bin/admin/optimizedir.cgi?function=<value>\[&channel=<value>\]](http://<servername>/cgi-bin/admin/optimizedir.cgi?function=<value>[&channel=<value>])

PARAMETER	VALUE	DESCRIPTION
channel	0~"capability_nvideoin"-1	Channel of the video source.
function	getstatus, onetimeauto	<p>"onetimeauto": Camera will automatically adjust the IR zone one time only.</p> <p>"getstatus": Information of optimized IR control status and return value as below:</p> <p>optimizedir_c<0~(n-1)>_irmode: Indicate the IR current mode, available value is "auto" and "manual" mode.</p> <p>optimizedir_c<0~(n-1)>_irnum: The number of IR that camera supports.</p> <p>optimizedir_c<0~(n-1)>_irstrength: Only available when irmode is set as manual. It's a set of integers, which indicate the strength of each IR LED (e.g. 23,45,100,100).</p> <p>optimizedir_c<0~(n-1)>_irstatus: Current IR status, normal / adjusting:</p> <p>"normal": the IR LED strength has been fixed.</p> <p>"adjusting": the IR LED strength is adjusting.</p>

Example:

<http://myserver/cgi-bin/admin/optimizedir.cgi?function=getstatus>

Response:

```
HTTP/1.0 200 OK\r\n
Cache-control: no-cache\r\n
Pragma: no-cache\r\n
\r\n
"optimizedir_c0_irmode='auto'"
"optimizedir_c0_irnum='5'"
"optimizedir_c0_irstrength='1,97,100,100,100'"
"optimizedir_c0_irstatus='normal'"
```

Syntax: **(for control API)**

錯誤! 超連結參照不正確。 ?channel=<value>&operation=<value>&irmode=manual
 [&strength=<value>] – Set IR strength

PARAMETER	VALUE	DESCRIPTION
channel	0~"capability_nvideoin"-1	Channel of the video source.
operation	set, settoall	"set": set the strength of each IR LED separately "settoall": use fixed strength for all IR LED
irmode	auto, manual	Irmode needs to be set as manual for adjusting IR LED strength.
strength	1~100	If the operation is set as "set", the number of strength values need to be the same as it of irnum. However, it needs only one value for strength when the operation is set as "settoall".

Example:

<http://myserver/cgi-bin/admin/optimizedir.cgi?channel=0&operation=set&irmode=manual&strength=50,70,50,50,50>

Response:

```
HTTP/1.0 200 OK\r\n
Cache-control: no-cache\r\n
Pragma: no-cache\r\n
\r\n
"optimizedir_c0_irstrength='50,70,50,50,50'"
"optimizedir_c0_irmode='manual'"
```

Example:

```
http://myserver/cgi-bin/admin/optimizedir.cgi?channel=0&operation=settoall&irmode>manual&strength=100
```

Response:

```
HTTP/1.0 200 OK\r\n
Cache-control: no-cache\r\n
Pragma: no-cache\r\n
\r\n
"optimizedir_c0_irstrength='100,100,100,100,100'"
"optimizedir_c0_irmode='manual'"
```

Example:

```
http://myserver/cgi-bin/admin/optimizedir.cgi?channel=0&operation=set&irmode=auto&strength=50,70,50,50,50
```

Response:

```
HTTP/1.0 200 OK\r\n
Cache-control: no-cache\r\n
Pragma: no-cache\r\n
\r\n
ERROR: Parameter "irmode" must be set as "manual"!
```

Example:

```
http://myserver/cgi-bin/admin/optimizedir.cgi?channel=0&operation=set&strength=50,70,50,50,50
```

Response:

```
HTTP/1.0 200 OK\r\n
Cache-control: no-cache\r\n
Pragma: no-cache\r\n
\r\n
ERROR: Must have the "irmode=manual" argument!
```

Syntax: **(for querying API)**

錯誤! 超連結參照不正確。

[&support_irmode] – list all adjustment mode that IR supports

[&irmode] – Get current IR mode

[&irnum] – Get the number of IR zone

PARAMETER	VALUE	DESCRIPTION
channel	0~"capability_nvideoin"-1	Channel of the video source.
support_irmode	N/A	List all adjustment mode that IR supports
irmode	N/A	Get the current IR control mode.
irnum	N/A	Get the number of IR that camera supports.

Example:

<http://myserver/cgi-bin/admin/optimizedir.cgi?channel=0&operation=get&irmode>

Response:

HTTP/1.0 200 OK\r\n

Cache-control: no-cache\r\n

Pragma: no-cache\r\n

\r\n

"optimizedir_c0_irmode='auto'"

<End of document>

Technology License Notice

AMR-NB Standard

THIS PRODUCT IS LICENSED UNDER THE AMR-NB STANDARD PATENT LICENSE AGREEMENT. WITH RESPECT TO THE USE OF THIS PRODUCT, THE FOLLOWING LICENSORS' PATENTS MAY APPLY:

TELEFONAKIEBOLAGET ERICSSON AB: US PAT. 6192335; 6275798; 6029125; 6424938; 6058359. NOKIA CORPORATION: US PAT. 5946651; 6199035. VOICEAGE CORPORATION: AT PAT. 0516621; BE PAT. 0516621; CA PAT. 2010830; CH PAT. 0516621; DE PAT. 0516621; DK PAT. 0516621; ES PAT. 0516621; FR PAT. 0516621; GB PAT. 0516621; GR PAT. 0516621; IT PAT. 0516621; LI PAT. 0516621; LU PAT. 0516621; NL PAT. 0516621; SE PAT. 0516621; US PAT. 5444816; AT PAT. 819303/AT E 198805T1; AU PAT. 697256; BE PAT. 819303; BR PAT. 9604838-7; CA PAT. 2216315; CH PAT. 819303; CN PAT. ZL96193827.7; DE PAT. 819303/DE69611607T2; DK PAT. 819303; ES PAT. 819303; EP PAT. 819303; FR PAT. 819303; GB PAT. 819303; IT PAT. 819303; JP PAT. APP. 8-529817; NL PAT. 819303; SE PAT. 819303; US PAT. 5664053. THE LIST MAY BE UPDATED FROM TIME TO TIME BY LICENSORS AND A CURRENT VERSION OF WHICH IS AVAILABLE ON LICENSOR'S WEBSITE AT [HTTP://WWW.VOICEAGE.COM](http://www.voiceage.com).



Notices from HEVC Advance:

THIS PRODUCT IS SOLD WITH A LIMITED LICENSE AND IS AUTHORIZED TO BE USED ONLY IN CONNECTION WITH HEVC CONTENT THAT MEETS EACH OF THE THREE FOLLOWING QUALIFICATIONS: (1) HEVC CONTENT ONLY FOR PERSONAL USE; (2) HEVC CONTENT THAT IS NOT OFFERED FOR SALE; AND (3) HEVC CONTENT THAT IS CREATED BY THE OWNER OF THE PRODUCT. THIS PRODUCT MAY NOT BE USED IN CONNECTION WITH HEVC ENCODED CONTENT CREATED BY A THIRD PARTY, WHICH THE USER HAS ORDERED OR PURCHASED FROM A THIRD PARTY, UNLESS THE USER IS SEPARATELY GRANTED RIGHTS TO USE THE PRODUCT WITH SUCH CONTENT BY A LICENSED SELLER OF THE CONTENT. YOUR USE OF THIS PRODUCT IN CONNECTION WITH HEVC ENCODED CONTENT IS DEEMED ACCEPTANCE OF THE LIMITED AUTHORITY TO USE AS NOTED ABOVE.

H.264

THIS PRODUCT IS LICENSED UNDER THE AVC PATENT PORTFOLIO LICENSE FOR THE PERSONAL AND NON-COMMERCIAL USE OF A CONSUMER TO (i) ENCODE VIDEO IN COMPLIANCE WITH THE AVC STANDARD ("AVC VIDEO") AND/OR (ii) DECODE AVC VIDEO THAT WAS ENCODED BY A CONSUMER ENGAGED IN A PERSONAL AND NON-COMMERCIAL ACTIVITY AND/OR WAS OBTAINED FROM A VIDEO PROVIDER LICENSED TO PROVIDE AVC VIDEO. NO LICENSE IS GRANTED OR SHALL BE IMPLIED FOR ANY OTHER USE. ADDITIONAL INFORMATION MAY BE OBTAINED FROM MPEG LA, L.L.C. SEE [HTTP://WWW.MPEGLA.COM](http://www.mpegla.com)

Electromagnetic Compatibility (EMC)

FCC Statement

This device complies with FCC Rules Part 15. Operation is subject to the following two conditions.

- This device may not cause harmful interference, and
- This device must accept any interference received, including interference that may cause undesired operation.

This equipment has been tested and found to comply with the limits for a Class B digital device, pursuant to Part 15 of the FCC Rules. These limits are designed to provide reasonable protection against harmful interference in a residential installation. This equipment generates, uses and can radiate radio frequency energy and, if not installed and used in accordance with the instructions, may cause harmful interference to radio communications. However, there is no guarantee that interference will not occur in a partial installation. If this equipment does cause harmful interference to radio or television reception, which can be determined by turning the equipment off and on, the user is encouraged to try to correct the interference by one or more of the following measures:

- Reorient or relocate the receiving antenna.
- Increase the separation between the equipment and receiver.
- Connect the equipment into an outlet on a circuit different from that to which the receiver is connected.
- Consult the dealer or an experienced radio/TV technician for help.

Shielded interface cables must be used in order to comply with emission limits.

CE Mark Warning

This is a Class B product. In a domestic environment, this product may cause radio interference, in which case the user may be required to take adequate measures.

VCCI Warning

この装置は、情報処理装置等電波障害自主規制協議会（VCCI）の基準に基づくクラスB情報技術装置です。この装置は、家庭環境で使用することを目的としていますが、この装置がラジオやテレビジョン受信機に近接して使用されると、受信障害を引き起こすことがあります。

取扱説明書に従って正しい取り扱いをして下さい

Liability

VIVOTEK Inc. cannot be held responsible for any technical or typographical errors and reserves the right to make changes to the product and manuals without prior notice. VIVOTEK Inc. makes no warranty of any kind with regard to the material contained within this document, including, but not limited to, the implied warranties of merchantability and fitness for any particular purpose.