



Network Video Recorder

Quick Start Guide

TABLE OF CONTENTS

Chapter1 Panels Description	8
1.1 Front Panel.....	8
1.1.1 DS-9600NI Series.....	8
1.1.2 DS-7700NI Series.....	12
1.1.3 DS-7600NI Series.....	14
1.2 Rear Panel.....	14
1.2.1 DS-9600NI Series.....	14
1.2.2 DS-7700NI Series.....	16
1.2.3 DS-7600NI Series.....	17
Chapter 2 Installation and Connections	19
2.1 Installation.....	19
2.2 Hard Disk Installation.....	19
2.2.1 Front Panel Plug-Pull Installation.....	19
2.2.2 Fix-on-Bottom Installation.....	20
2.3 Connections.....	21
2.3.1 Alarm Input Wiring.....	21
2.3.2 Alarm Output Wiring.....	22
2.3.3 Alarm Connection.....	22
2.3.4 Controller Connection.....	23
2.4 HDD Storage Calculation Chart.....	24
Chapter 3 Menu Operation.....	25
3.1 Start up Your Device.....	25
3.2 Activate Your Device.....	25
3.3 Configure Unlock Pattern for Login.....	26
3.4 Log in to the System.....	27
3.5 Enter Wizard to Configure Quick Basic Settings.....	27
3.6 Network Settings.....	28
3.7 Add IP Cameras.....	29
3.8 Start Live View.....	30
3.9 One-Touch RAID Configuration.....	30
3.10 Recording Settings.....	31
3.11 Playback.....	32
Chapter 4 Access by Web Browser.....	34

Quick Start Guide

COPYRIGHT ©2018 Hangzhou Hikvision Digital Technology Co., Ltd.

ALL RIGHTS RESERVED.

Any and all information, including, among others, wordings, pictures, graphs are the properties of Hangzhou Hikvision Digital Technology Co., Ltd. or its subsidiaries (hereinafter referred to be “Hikvision”). This user manual (hereinafter referred to be “the Manual”) cannot be reproduced, changed, translated, or distributed, partially or wholly, by any means, without the prior written permission of Hikvision. Unless otherwise stipulated, Hikvision does not make any warranties, guarantees or representations, express or implied, regarding to the Manual.

About this Manual

This Manual is applicable to Network Video Recorder (NVR).

The Manual includes instructions for using and managing the product. Pictures, charts, images and all other information hereinafter are for description and explanation only. The information contained in the Manual is subject to change, without notice, due to firmware updates or other reasons. Please find the latest version in the company website (<http://overseas.hikvision.com/en/>).

Please use this user manual under the guidance of professionals.

Trademarks Acknowledgement

HIKVISION and other Hikvision’s trademarks and logos are the properties of Hikvision in various jurisdictions. Other trademarks and logos mentioned below are the properties of their respective owners.

Legal Disclaimer

TO THE MAXIMUM EXTENT PERMITTED BY APPLICABLE LAW, THE PRODUCT DESCRIBED, WITH ITS HARDWARE, SOFTWARE AND FIRMWARE, IS PROVIDED “AS IS”, WITH ALL FAULTS AND ERRORS, AND HIKVISION MAKES NO WARRANTIES, EXPRESS OR IMPLIED, INCLUDING WITHOUT LIMITATION, MERCHANTABILITY, SATISFACTORY QUALITY, FITNESS FOR A PARTICULAR PURPOSE, AND NON-INFRINGEMENT OF THIRD PARTY. IN NO EVENT WILL HIKVISION, ITS DIRECTORS, OFFICERS, EMPLOYEES, OR AGENTS BE LIABLE TO YOU FOR ANY SPECIAL, CONSEQUENTIAL, INCIDENTAL, OR INDIRECT DAMAGES, INCLUDING, AMONG OTHERS, DAMAGES FOR LOSS OF BUSINESS PROFITS, BUSINESS INTERRUPTION, OR LOSS OF DATA OR DOCUMENTATION, IN CONNECTION WITH THE USE OF THIS PRODUCT, EVEN IF HIKVISION HAS BEEN ADVISED OF THE POSSIBILITY OF SUCH DAMAGES.

REGARDING TO THE PRODUCT WITH INTERNET ACCESS, THE USE OF PRODUCT SHALL BE WHOLLY AT YOUR OWN RISKS. HIKVISION SHALL NOT TAKE ANY RESPONSIBILITES FOR ABNORMAL OPERATION, PRIVACY LEAKAGE OR OTHER DAMAGES RESULTING FROM CYBER ATTACK, HACKER ATTACK, VIRUS INSPECTION, OR OTHER INTERNET SECURITY RISKS; HOWEVER, HIKVISION WILL PROVIDE TIMELY TECHNICAL SUPPORT IF REQUIRED.

SURVEILLANCE LAWS VARY BY JURISDICTION. PLEASE CHECK ALL RELEVANT LAWS IN YOUR JURISDICTION BEFORE USING THIS PRODUCT IN ORDER TO ENSURE THAT YOUR USE CONFORMS THE APPLICABLE LAW. HIKVISION SHALL NOT BE LIABLE IN THE EVENT THAT THIS PRODUCT IS USED WITH ILLEGITIMATE PURPOSES.

IN THE EVENT OF ANY CONFLICTS BETWEEN THIS MANUAL AND THE APPLICABLE LAW, THE LATER PREVAILS.

Regulatory Information

FCC Information

Please take attention that changes or modification not expressly approved by the party responsible for compliance could void the user's authority to operate the equipment.

FCC compliance: This equipment has been tested and found to comply with the limits for a Class A digital device, pursuant to part 15 of the FCC Rules. These limits are designed to provide reasonable protection against harmful interference when the equipment is operated in a commercial environment. This equipment generates, uses, and can radiate radio frequency energy and, if not installed and used in accordance with the instruction manual, may cause harmful interference to radio communications. Operation of this equipment in a residential area is likely to cause harmful interference in which case the user will be required to correct the interference at his own expense.

FCC Conditions

This device complies with part 15 of the FCC Rules. Operation is subject to the following two conditions:

1. This device may not cause harmful interference.
2. This device must accept any interference received, including interference that may cause undesired operation.

EU Conformity Statement

 This product and - if applicable - the supplied accessories too are marked with "CE" and comply therefore with the applicable harmonized European standards listed under the EMC Directive 2014/30/EU, the LVD Directive 2014/35/EU, the RoHS Directive 2011/65/EU.

 2012/19/EU (WEEE directive): Products marked with this symbol cannot be disposed of as unsorted municipal waste in the European Union. For proper recycling, return this product to your local supplier upon the purchase of equivalent new equipment, or dispose of it at designated collection points. For more information see: www.recyclethis.info

 2006/66/EC (battery directive): This product contains a battery that cannot be disposed of as unsorted municipal waste in the European Union. See the product documentation for specific battery information. The battery is marked with this symbol, which may include lettering to indicate cadmium (Cd), lead (Pb), or mercury (Hg). For proper recycling, return the battery to your supplier or to a designated collection point. For more information see: www.recyclethis.info

Industry Canada ICES-003 Compliance

This device meets the CAN ICES-3 (A)/NMB-3(A) standards requirements.



Applicable Models

This manual is applicable to the models listed in the following table.

Series	Model
DS-9600NI-I8	DS-9608NI-I8
	DS-9616NI-I8
	DS-9632NI-I8
	DS-9664NI-I8
DS-9600NI-I16	DS-9616NI-I16
	DS-9632NI-I16
	DS-9664NI-I16
DS-7600NI-I2	DS-7608NI-I2
	DS-7616NI-I2
	DS-7632NI-I2
DS-7600NI-I2/P	DS-7608NI-I2/8P
	DS-7616NI-I2/16P
	DS-7632NI-I2/16P
DS-7700NI-I4	DS-7708NI-I4
	DS-7716NI-I4
	DS-7732NI-I4
DS-7700NI-I4(B)	DS-7716NI-I4(B)
	DS-7732NI-I4(B)
DS-7700NI-I4/P	DS-7708NI-I4/8P
	DS-7716NI-I4/16P
	DS-7732NI-I4/16P
DS-7700NI-I4/P(B)	DS-7716NI-I4/P(B)
	DS-7732NI-I4/P(B)

Symbol Conventions

The symbols that may be found in this document are defined as follows.

Symbol	Description
 NOTE	Provides additional information to emphasize or supplement important points of the main text.
 WARNING	Indicates a potentially hazardous situation, which if not avoided, could result in equipment damage, data loss, performance degradation, or unexpected results.
 DANGER	Indicates a hazard with a high level of risk, which if not avoided, will result in death or serious injury.

Safety Instructions

- Proper configuration of all passwords and other security settings is the responsibility of the installer and/or end-user.
- In the use of the product, you must be in strict compliance with the electrical safety regulations of the nation and region. Please refer to technical specifications for detailed information.
- Input voltage should meet both the SELV (Safety Extra Low Voltage) and the Limited Power Source with 100~240 VAC, 48 VDC or 12 VDC according to the IEC60950-1 standard. Please refer to technical specifications for detailed information.
- Do not connect several devices to one power adapter as adapter overload may cause over-heating or a fire hazard.
- Please make sure that the plug is firmly connected to the power socket.
- If smoke, odor or noise rise from the device, turn off the power at once and unplug the power cable, and then please contact the service center.

Preventive and Cautionary Tips

Before connecting and operating your device, please be advised of the following tips:

- Ensure unit is installed in a well-ventilated, dust-free environment.
- Unit is designed for indoor use only.
- Keep all liquids away from the device.
- Ensure environmental conditions meet factory specifications.
- Ensure unit is properly secured to a rack or shelf. Major shocks or jolts to the unit as a result of dropping it may cause damage to the sensitive electronics within the unit.
- Use the device in conjunction with an UPS if possible.
- Power down the unit before connecting and disconnecting accessories and peripherals.
- A factory recommended HDD should be used for this device.
- Improper use or replacement of the battery may result in hazard of explosion. Replace with the same or equivalent type only. Dispose of used batteries according to the instructions provided by the battery manufacturer.

- When installing the device into a cabinet over 2U height, it is suggest to use rack shelf to bear the weight. If the cabinet height is over 4U, it is suggest to use slide rails or rack shelf to bear the weight.

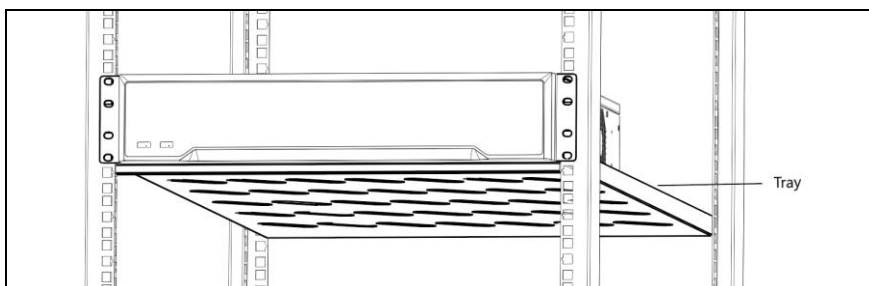

Chapter1 Panels Description

1.1 Front Panel

1.1.1 DS-9600NI Series

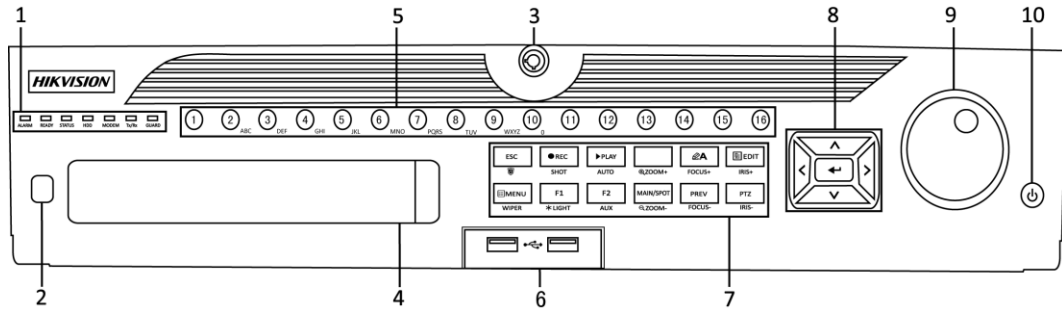

Figure 1-1 DS-9600NI-I8 Series

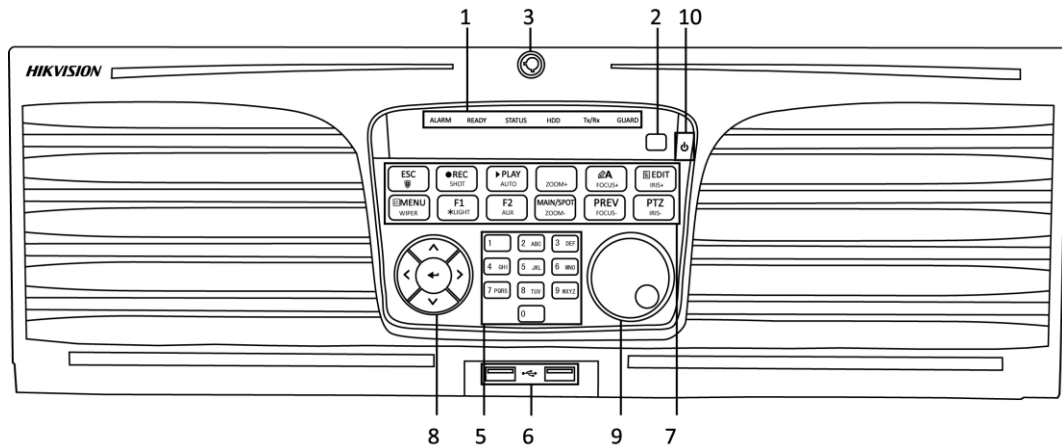

Figure 1-2 DS-9600NI-I16 Series

Table 1-1 Panel Description

No.	Name	Function Description	
1	Status Indicators	ALARM	Turns red when a sensor alarm is detected.
		READY	Turns blue when the device is functioning properly.
		STATUS	Turns blue when device is controlled by an IR remote.
			Turns red when controlled by a keyboard and purple when IR remote and keyboard is used at the same time.
		HDD	Flickers red when data is being read from or written to HDD.
		MODEM	Reserved for future usage.
		Tx/Rx	Flickers blue when network connection is functioning properly.
		GUARD	Turns blue when the device is in armed status; at this time, an alarm is enabled when an event is detected.
Turns off when the device is unarmed. The arm/disarm status can be changed by pressing and holding on the ESC button for more than 3 seconds in live view mode.			
2	IR Receiver	Receiver for IR remote control.	
3	Front Panel Lock	Locks or unlocks the panel by the key.	
4	DVD-R/W	Slot for DVD-R/W disk.	
5	Alphanumeric Buttons	Switches to the corresponding channel in live view or PTZ control mode.	
		Inputs numbers and characters in edit mode.	
		Switches between different channels in playback mode.	
		Turns blue when the corresponding channel is recording; turns red when the channel is in network transmission status; turns pink when the channel is recording and transmitting.	

No.	Name	Function Description	
6	USB Interfaces	Universal Serial Bus (USB) ports for additional devices such as USB mouse and USB Hard Disk Drive (HDD).	
7	Composite Keys	ESC	Returns to the previous menu.
		REC/SHOT	Presses for arming/disarming the device in live view mode.
			Enters the Manual Record settings menu.
			Presses this button followed by a numeric button to call a PTZ preset in PTZ control settings.
		PLAY/AUTO	Turns audio on/off in the playback mode.
			Enters the playback mode.
		ZOOM+	Automatically scans in the PTZ control menu.
			Zooms in the PTZ camera in the PTZ control setting.
		A/FOCUS+	Adjusts focus in the PTZ Control menu.
			Switches between input methods (upper and lower case alphabet, symbols and numeric input).
		EDIT/IRIS+	Edits text fields. When editing text fields, it also deletes the character in front of the cursor.
			Checks the checkbox in the checkbox fields.
			Adjusts the iris of the camera in PTZ control mode.
			Generates video clips for backup in playback mode.
Enters/exits the folder of USB device and eSATA HDD.			
MAIN/SPOT/ZOOM-	Switches between main and spot output.		
	Zooms out the image in PTZ control mode.		
F1/ LIGHT	Selects all items on the list when used in a list field.		

No.	Name		Function Description
8	Control Buttons		Turns on/off PTZ light (if applicable) in PTZ control mode.
			Switches between play and reverse play in playback mode.
		F2/ AUX	Cycles through tab pages.
			Switches between channels in synchronous playback mode.
		MENU/WIPER	Returns to the Main menu (after successful login).
			Presses and holds the button for five seconds to turn off audible key beep.
			Starts wiper (if applicable) in PTZ control mode.
			Shows/hides the control interface in playback mode.
		PREV/FOCUS-	Switches between single screen and multi-screen mode.
			Adjusts the focus in conjunction with the A/FOCUS+ button in PTZ control mode.
		PTZ/IRIS-	Enters the PTZ Control mode.
			Adjusts the iris of the PTZ camera in PTZ control mode.
		DIRECTION	Navigates between different fields and items in menus.
			In the playback mode, use the Up and Down buttons to speed up and slow down recorded video. Use the Left and Right buttons to select the next and previous video files.
			Cycles through channels in live view mode.
Controls the movement of the PTZ camera in PTZ control mode.			
ENTER	Confirms selection in any of the menu modes.		
	Checks the checkbox fields.		

No.	Name	Function Description
		Plays or pauses the video playing in playback mode.
		Advances the video by a single frame in single-frame playback mode.
		Stops/starts auto switch in auto-switch mode.
9	JOG SHUTTLE Control	Moves the active selection up and down in a menu.
		Cycles through different channels in live view mode.
		Jumps 30s forward/backward in video files in the playback mode.
		Controls the movement of the PTZ camera in PTZ control mode.
10	POWER ON/OFF	Long press the button for more than 3 seconds to turn on/off the NVR.

1.1.2 DS-7700NI Series

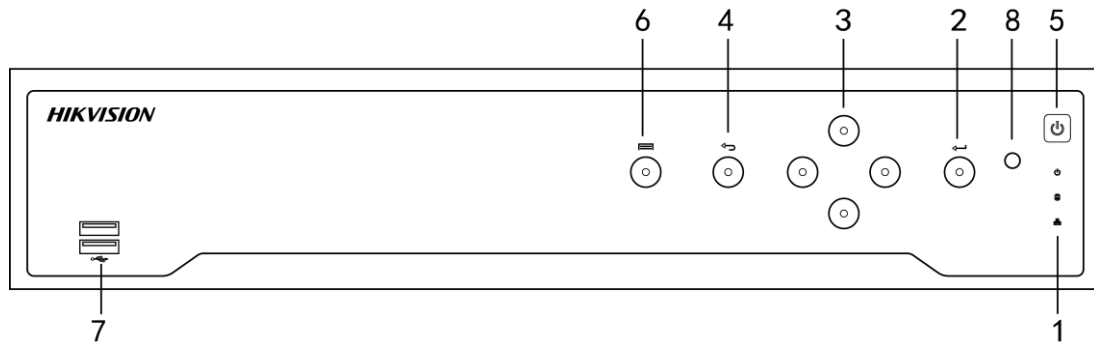

Figure 1-3 DS-7700NI Series

Table 1-2 Panel Description

No.	Name	Function Description	
1	Status Indicators	POWER	Turns green when NVR is powered up.
		HDD	Blinks red when HDD is reading/writing.
		Tx/Rx	Blinks green when network connection is functioning normally.
2	ENTER	The Enter button is used to confirm selection in menu mode; or used to check checkbox fields and ON/OFF switch.	
		In playback mode, it can be used to play or pause the video.	
		In single-frame play mode, pressing the Enter button will play the video by a single frame.	
		In auto sequence view mode, the buttons can be used to pause or resume auto sequence.	
		The Enter button is used to confirm selection in menu mode; or used to check checkbox fields and ON/OFF switch.	
3	DIRECTION	In menu mode, the direction buttons are used to navigate between different fields and items and select setting parameters.	
		In playback mode, the Up and Down buttons are used to speed up and slow down record playing, and the Left and Right buttons are used to move the recording 30s forwards or backwards.	
		In the image setting interface, the up and down button can adjust the level bar of the image parameters.	
		In live view mode, these buttons can be used to switch channels.	
4	Back	Back to the previous menu.	
5	POWER ON/OFF	Power on/off switch.	
6	MENU	Access the main menu interface.	
7	USB Interface	Universal Serial Bus (USB) ports for additional devices such as USB mouse and USB Hard Disk Drive (HDD).	

1.1.3 DS-7600NI Series

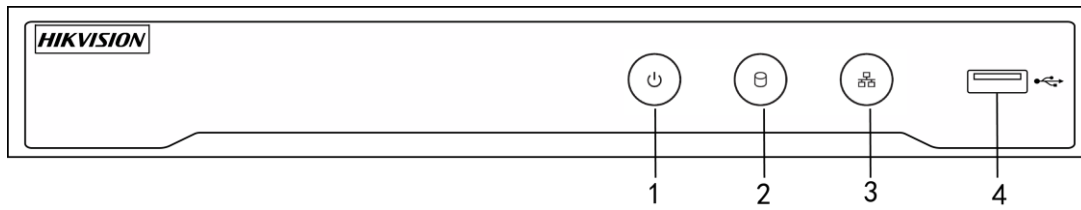

Figure 1-4 DS-7600NI Series

Table 1-3 Panel Description

No.	Name	Connections
1	POWER	Turns green when NVR is powered up.
2	HDD	Flickers red when data is being read from or written to HDD.
3	Tx/Rx	Flickers blue when network connection is functioning properly.
4	USB Interface	Universal Serial Bus (USB) port for additional devices such as USB mouse and USB Hard Disk Drive (HDD).

1.2 Rear Panel

1.2.1 DS-9600NI Series

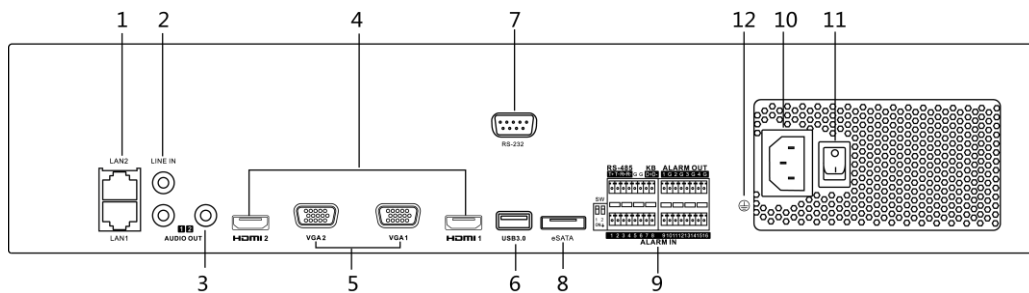

Figure 1-5 DS-9600NI-I8 Series

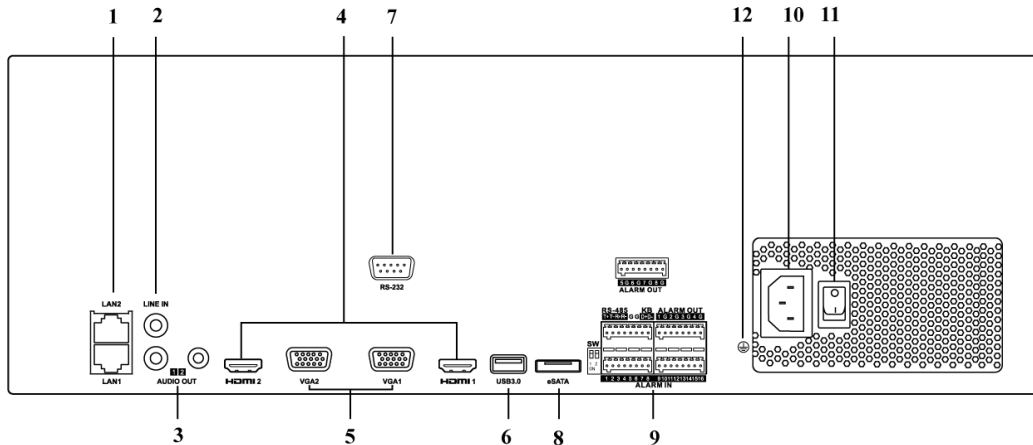

Figure 1-6 DS-9600NI-I16 Series

Table 1-4 Panel Description

No.	Name	Description
1	LAN1/LAN2 Interface	2 RJ-45 10/100/1000 Mbps self-adaptive Ethernet interfaces provided.
2	LINE IN	RCA connector for audio input.
3	AUDIO OUT	2 RCA connectors for audio output.
4	HDMI1/HDMI2	HDMI video output connector.
5	VGA1/VGA2	DB9 connector for VGA output. Display local video output and menu.
6	USB 3.0 interface	Universal Serial Bus (USB) ports for additional devices such as USB mouse and USB Hard Disk Drive (HDD).
7	RS-232 Interface	Connector for RS-232 devices.
9	Controller Port	D+, D- pin connects to Ta, Tb pin of controller. For cascading devices, the first NVR's D+, D- pin should be connected with the D+, D- pin of the next NVR.
	ALARM IN	Connector for alarm input.
	ALARM OUT	Connector for alarm output.
10	100 to 240 VAC	100 to 240 VAC power supply.
11	Power Switch	Switch for turning on/off the device.
12	GROUND	Ground (needs to be connected when NVR starts up).

1.2.2 DS-7700NI Series

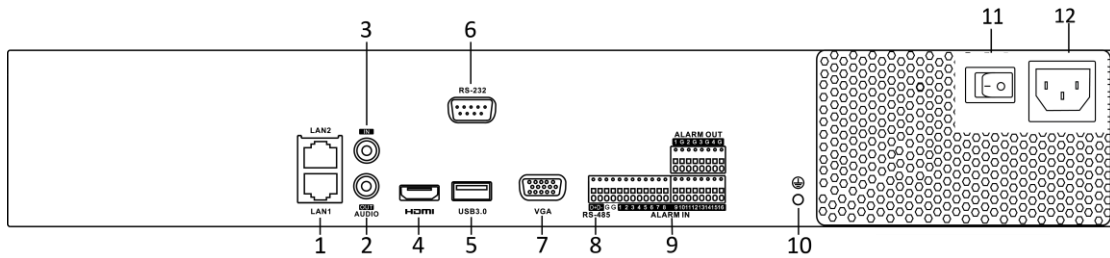

Figure 1-7 DS-7700NI-I4 and DS-7700NI-K4 Series

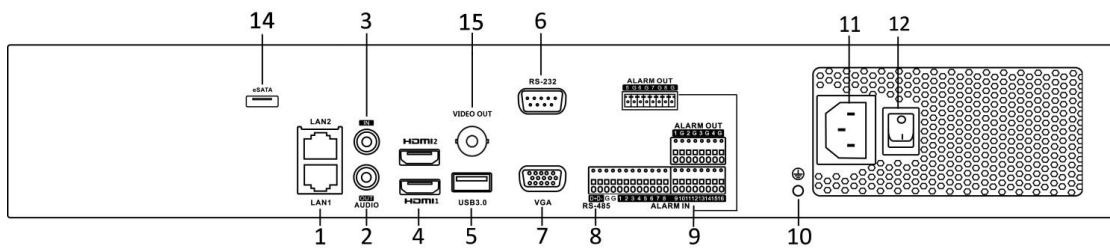

Figure 1-8 DS-7700NI-I4(B) and DS-7700NI-K4(B) Series

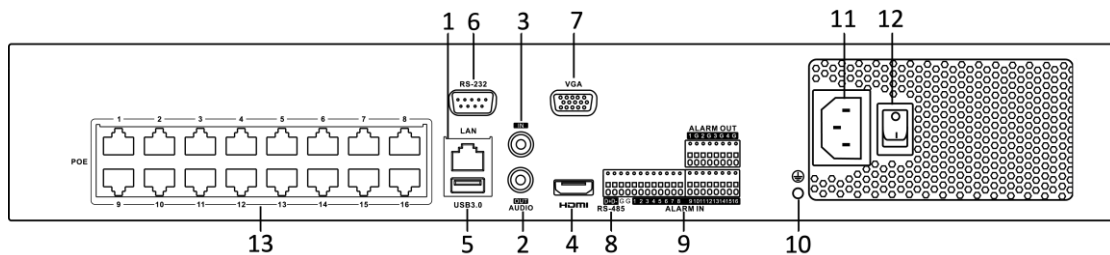

Figure 1-9 DS-7700NI-I4/16P and DS-7700NI-K4/16P Series

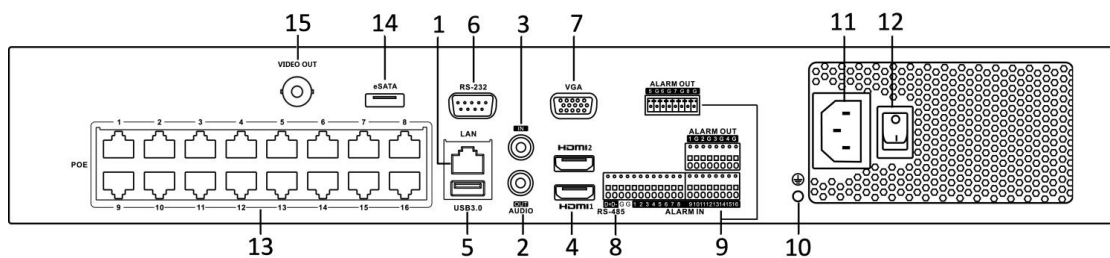

Figure 1-10 DS-7700NI-I4/16P(B) and DS-7700NI-K4/16P(B) Series

NOTE

The DS-7708NI-I4/8P and DS-7708NI-K4/8P provides 8 network Interfaces with PoE function.

Table 1-5 Panel Description

No.	Name	Description
1	LAN Interface	1 network interface provided for DS-7700NI-I4/P and DS-7700NI-K4/P, and 2 network interfaces for DS-7700NI-I4 and DS-7700NI-K4.

2	AUDIO OUT	RCA connector for audio output.
3	LINE IN	RCA connector for audio input.
4	HDMI	HDMI video output connector.
5	USB 3.0 interface	Universal Serial Bus (USB) ports for additional devices such as USB mouse and USB Hard Disk Drive (HDD).
6	RS-232 Interface	Connector for RS-232 devices.
7	VGA	DB9 connector for VGA output. Display local video output and menu.
8	RS-485 Interface	Half-duplex connector for RS-485 devices.
9	ALARM IN	Connector for alarm input.
	ALARM OUT	Connector for alarm output.
10	GROUND	Ground (needs to be connected when NVR starts up).
11	AC 100V ~ 240V	100V to 240VAC power supply.
12	Power Switch	Switch for turning on/off the device.
13	Network Interfaces with PoE function (supported by DS-7700NI-I4/P)	Network interfaces for the cameras and to provide power over Ethernet.
14	eSATA	Connects external SATA HDD, CD/DVD-RW.
15	VIDEO OUT	BNC connector for video output.

1.2.3 DS-7600NI Series

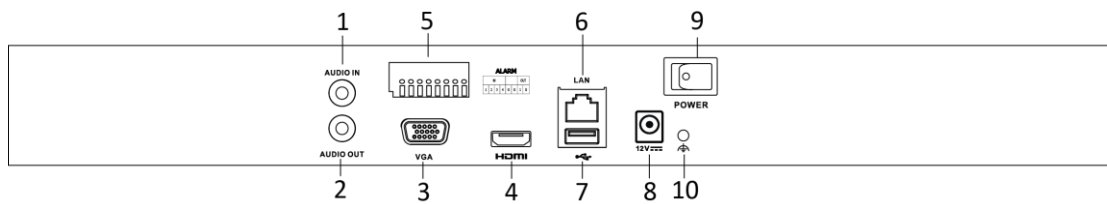

Figure 1-11 DS-7600NI-I2 Series

Network Video Recorder Quick Start Guide

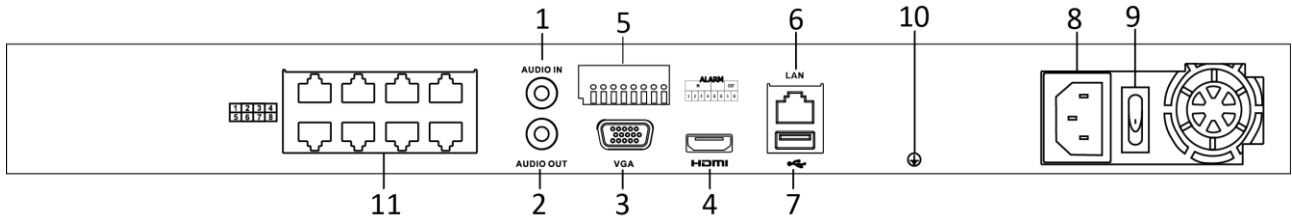

Figure 1-12 DS-7600NI-I2/8P Series

NOTE

The DS-7616NI-I2/16P and DS-7632NI-I2/16P provide 16 network Interfaces with PoE function.

Panel Description

Table 1-6 Panel Description

No.	Name	Description
1	Audio In	RCA connector for audio input.
2	Audio Out	RCA connector for audio output.
3	VGA Interface	DB9 connector for VGA output. Display local video output and menu.
4	HDMI Interface	HDMI video output connector.
5	ALARM IN	Connector for alarm input.
	ALARM OUT	Connector for alarm output.
6	LAN Network Interface	1 10/100/1000 Mbps self-adaptive Ethernet interface
7	USB Interface	Universal Serial Bus (USB 3.0) ports for additional devices such as USB mouse and USB Hard Disk Drive (HDD).
8	Power Supply	12 VDC power supply for DS-7600NI-I4, and 100 to 240 VAC for DS-7600NI-I4/P.
9	Power Switch	Switch for turning on/off the device.
10	Ground	Ground (needs to be connected when NVR starts up).
11	Network Interfaces with PoE function (supported by DS-7600NI-I2/P)	Network interfaces for the cameras and to provide power over Ethernet.

Chapter 2 Installation and Connections

2.1 Installation

During installation of the NVR:

- Use brackets for rack mounting.
- Ensure ample room for audio and video cables.
- When routing cables, ensure that the bend radius of the cables are no less than five times than its diameter.
- Connect the alarm cable.
- Allow at least 2cm (≈0.75-inch) of space between racks mounted devices.
- Ensure the NVR is grounded.
- Environmental temperature should be within the range of -10° to +55° C (+14° to +131° F).
- Environmental humidity should be within the range of 10% to 90%.

2.2 Hard Disk Installation

Before You Start

Disconnect the power from the NVR before installing a hard disk drive (HDD). A factory recommended HDD should be used for this installation.

Tools Required: Screwdriver.

2.2.1 Front Panel Plug-Pull Installation

Front panel plug-pull installation is applicable when you need to open the device front panel with key and install the HDD.

Step 1 Fix mounting ears to HDD with screws.

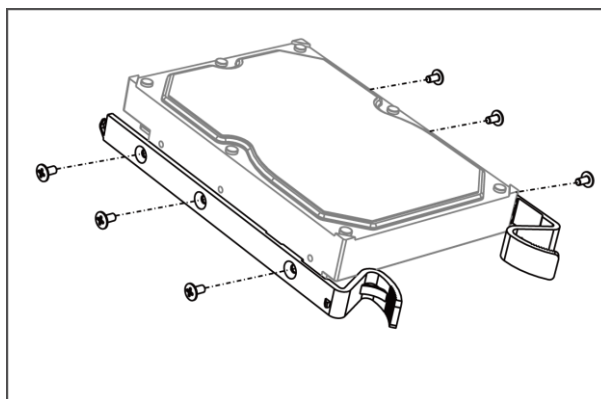

Figure 2-1 Fix Mounting Ears to HDD

Step 2 Unlock the front panel with the attached key, and press the buttons on both sides of the front panel to open it.

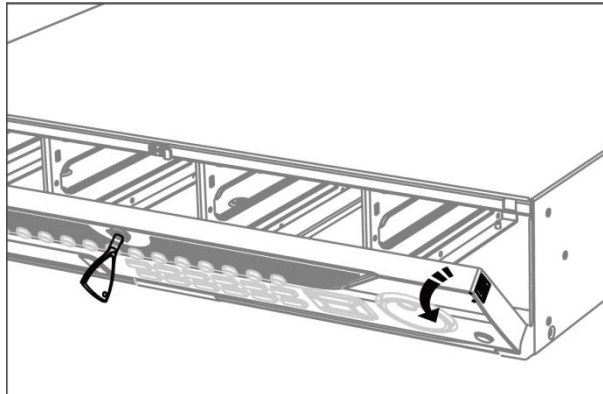

Figure 2-2 Open Front Panel

Step 3 Insert the HDD until it is fixed firmly.

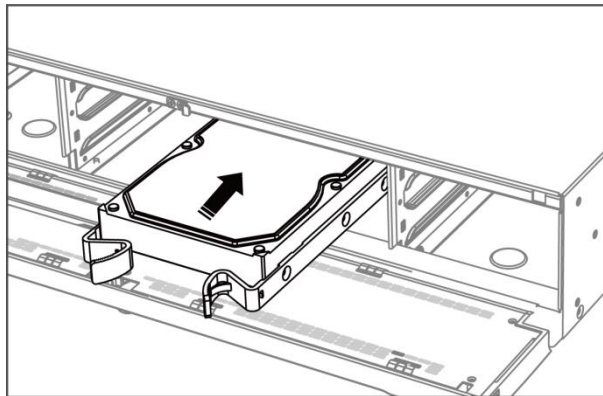

Figure 2-3 Insert HDD

Step 4 (Optional) Repeat the steps above to install other HDDs.

Step 5 Close the front panel and lock it with key.

2.2.2 Fix-on-Bottom Installation

Fix-on-bottom installation is applicable when you need to install and fix the HDD on the device bottom.

Step 1 Remove the cover from device by unfastening the screws on panels.

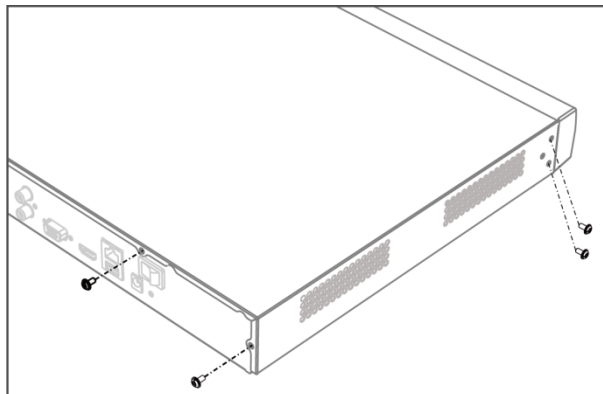

Figure 2-4 Remove Cover

Step 2 Connect the data cable and power cable.

- 1) Connect one end of data cable to the device motherboard.
- 2) Connect the other end of data cable to HDD.
- 3) Connect one end of power cable to HDD.
- 4) Connect the other end of power cable to the device motherboard.

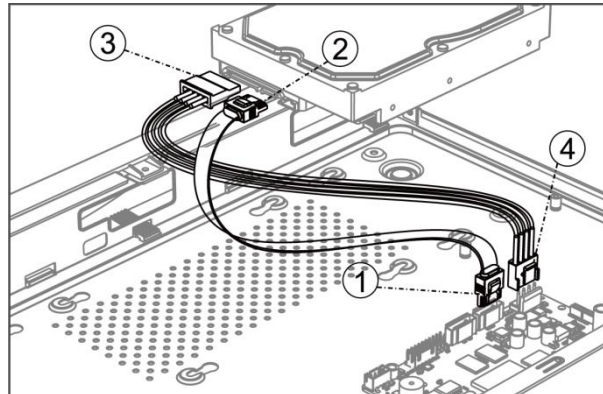

Figure 2-5 Connect Cables

Step 3 Set the device up, match HDD screw threads with the reserved holes on the device bottom, and fix HDD with screws.

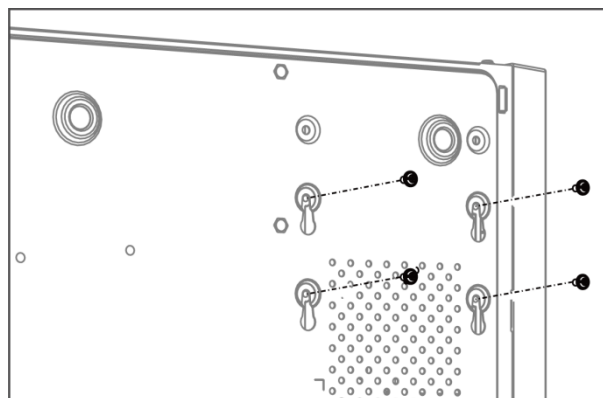

Figure 2-6 Fix HDD to Device Bottom

Step 4 (Optional) Repeat the steps above to install other HDDs.

Step 5 Reinstall the device cover and fasten screws.

2.3 Connections

2.3.1 Alarm Input Wiring

The alarm input is an open/closed relay. To connect the alarm input to the device, use the following diagram.



If the alarm input is not an open/close relay, connect an external relay between the alarm input and the device.

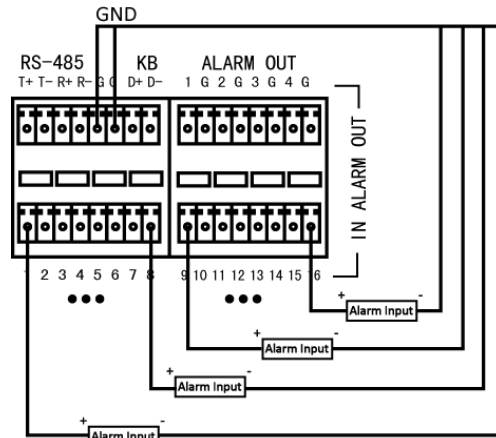

Figure 2-7 Alarm Input Wiring

2.3.2 Alarm Output Wiring

To connect to an alarm output (AC or DC load), use the following diagram:

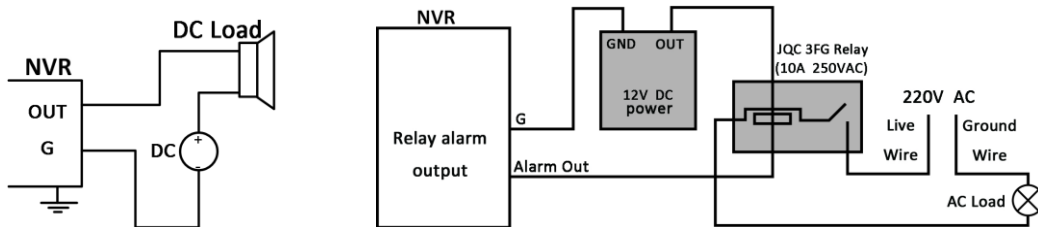

Figure 2-8 Alarm Output Wiring

For a DC load, the jumpers can be used within the limit of 12V/1A safely.

To connect an AC load, jumpers should be left open (you must remove the jumper on the motherboard in the NVR). Use an external relay for safety (as shown in the figure above).

There are 4 jumpers (JP6, JP9, JP10, and JP11) on the motherboard, each corresponding with one alarm output. By default, jumpers are connected. To connect an AC load, jumpers should be removed.

EXAMPLE:

If you connect an AC load to the NVR alarm output 3, you must remove the JP 3 jumper.

2.3.3 Alarm Connection

To connect alarm devices to the NVR:

- Step 1 Disconnect *pluggable block* from the ALARM IN /ALARM OUT terminal block.
- Step 2 Unfasten stop screws from the *pluggable block*, insert signal cables into slots and fasten stop screws. Ensure signal cables are tight.
- Step 3 Connect *pluggable block* back into terminal block.

2.3.4 Controller Connection

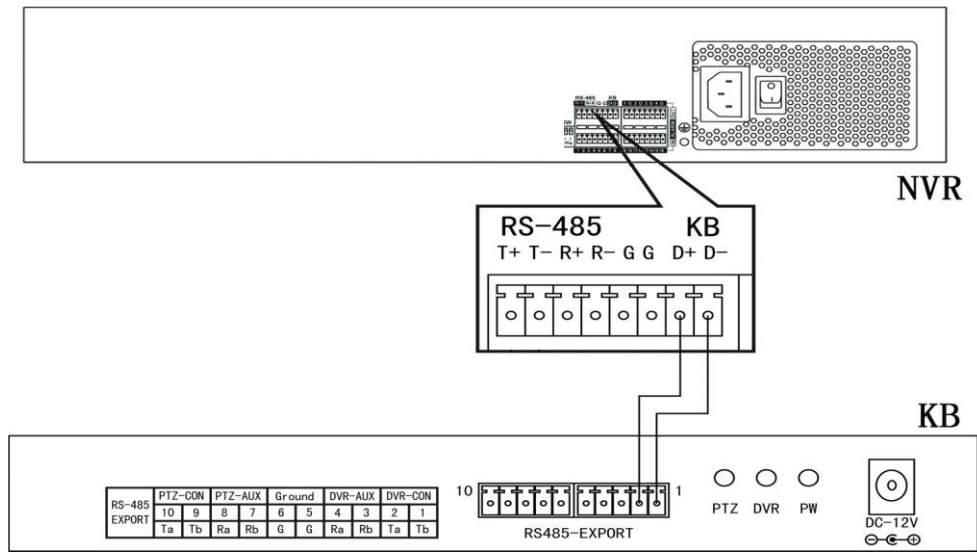

Figure 2-9 Controller Connection

To connect a controller to the NVR:

- Step 2 Disconnect pluggable block from the KB terminal block.
- Step 3 Unfasten stop screws from the KB D+, D- *pluggable block*, insert signal cables into slots and fasten stop screws. Ensure signal cables are in tight.
- Step 4 Connect Ta on controller to D+ on terminal block and Tb on controller to D- on terminal block. Fasten stop screws.
- Step 5 Connect *pluggable block* back into terminal block.

NOTE

Make sure both the controller and NVR are grounded.

2.4 HDD Storage Calculation Chart

The following chart shows an estimation of storage space used based on recording at one channel for an hour at a fixed bit rate.

Bit Rate	Storage Used
96K	42M
128K	56M
160K	70M
192K	84M
224K	98M
256K	112M
320K	140M
384K	168M
448K	196M
512K	225M
640K	281M
768K	337M
896K	393M
1024K	450M
1280K	562M
1536K	675M
1792K	787M
2048K	900M
4096K	1.8G
8192K	3.6G
16384K	7.2G

 **NOTE**

Please note that supplied values for storage space used is just for reference. The storage values in the chart are estimated by formulas and may have some deviation from actual value.

Chapter 3 Menu Operation

3.1 Start up Your Device

Proper startup and shutdown procedures are crucial to expanding the life of the NVR.

To start your device:

Step 1 Check the power supply is plugged into an electrical outlet. It is **HIGHLY** recommended that an Uninterruptible Power Supply (UPS) be used in conjunction with the device. The Power button on the front panel should be red, indicating the device is receiving the power.

Step 2 Press the power button on the front panel (depending on models). The Power LED should turn blue. The unit will begin to start.

After the device starts up, the wizard will guide you through the initial settings, including modifying password, date and time settings, network settings, HDD initializing, and recording.

3.2 Activate Your Device

For the first-time access, you must set an admin password to activate the device. No operation is allowed before activation. You can also activate a device via Web browser, SADP, or client software.

Step 1 Enter the admin password twice.

admin

Weak

Export GUID ?

Security Question Configuration

Reserved E-mail Settings ?

Create Channel Default Password

Note: Valid password range [8-16]. You can use a combination of numbers, lowercase, uppercase and special character for your password with at least two kinds of them contained.

OK

Figure 3-1 Set Admin Password

 **WARNING**

We highly recommend you create a strong password of your own choosing (using a minimum of 8 characters, including at least three of the following categories: upper case letters, lower case letters, numbers, and special characters.) in order to increase the security of your product. We also recommend that you reset your password regularly. Especially in the high security systems, resetting the password monthly or weekly can better protect your product.

Step 2 Enter the password to activate the IP camera(s) connected to the device.

Step 3 (Optional) Check **Export GUID**, **Security Question Configuration**, or **Reserved E-mail Settings**.

Export GUID: Export the GUID for future password resetting.

Security Question Configuration: Configure the security questions which can be used for resetting the password.

Reserved E-mail Settings: Set the reserved email for the future password resetting.

Step 4 Click **OK**.

3.3 Configure Unlock Pattern for Login

For the admin user, you can configure the unlock pattern for device login.

Step 1 After the device is activated, enter the following interface to configure the device unlock pattern.

Step 2 Use the mouse to draw a pattern among the 9 dots on the screen. Release the mouse when the pattern is done.

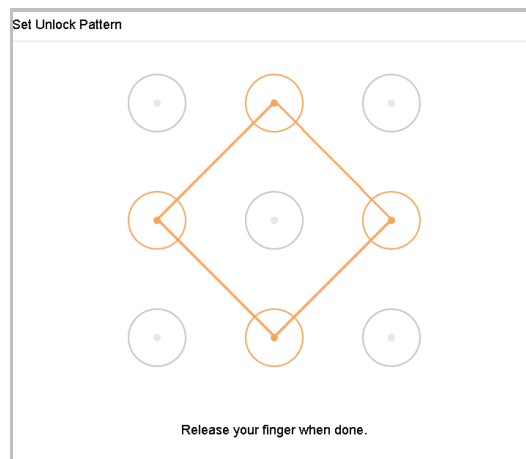

Figure 3-2 Draw the Pattern

 **NOTE**

- Connect at least 4 dots to draw the pattern.
- Each dot can be connected for once only.

Step 3 Draw the same pattern again to confirm it. When the two patterns match, the pattern is configured successfully.

 **NOTE**

If the two patterns are different, you must set the pattern again.

3.4 Log in to the System

If the device has logged out, you must log in the device before operating the menu and other functions. You can select to log in by unlock pattern or password input either.

Step 1 Right click the mouse on the screen and select the menu to enter the interface.

Step 2 Select the **User Name** in the drop-down list.

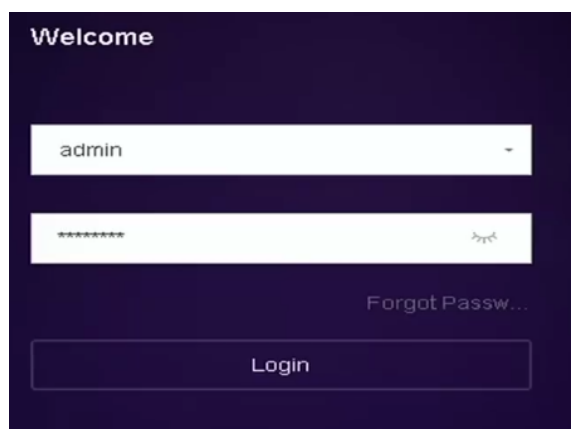

Figure 3-3 Login Interface

Step 3 Input Password.

Step 4 Click **Login** to log in.

 **NOTE**

In the Login dialog box, if you enter the wrong password 7 times, the current user account will be locked for 60 seconds.

3.5 Enter Wizard to Configure Quick Basic Settings

The Setup Wizard can walk you through some important settings of the device. By default, the Setup Wizard starts once the device has loaded.

Check the checkbox to enable Setup Wizard when device starts. Click **Next** to continue the setup wizard. Follow the guide of the Setup Wizard to configure the system resolution, system date/time, network settings, HDD management, record settings, etc.

The screenshot shows a 'Date and Time Setup' window. It contains four rows of configuration options: 'Time Zone' with a dropdown menu showing '(GMT+08:00) Beijing, Urume'; 'Date Format' with a dropdown menu showing 'DD-MM-YYYY'; 'System Date' with a text input '10-10-2017' and a calendar icon; and 'System Time' with a text input '16:12:33' and a plus icon. At the bottom left, there is a checked checkbox labeled 'Enable Wizard'. At the bottom right, there are three buttons: 'Previous', 'Next', and 'Exit'.

Figure 3-4 Wizard

3.6 Network Settings

Network settings must be properly configured before you operate the device over a network.

Step 1 Go to **System > Network > TCP/IP**.

The screenshot shows the 'TCP/IP' configuration page. At the top, there are tabs for 'TCP/IP', 'DDNS', 'PPPoE', 'NTP', and 'NAT'. The 'TCP/IP' tab is selected. The page contains several configuration fields: 'Working Mode' (dropdown: Net Fault-Tolerance), 'Select NIC' (dropdown: bond0), 'NIC Type' (dropdown: 10M/100M/1000M Self-adap), 'Enable DHCP' (checkbox: checked), 'IPv4 Address' (input: 10 . 15 . 2 . 107), 'IPv4 Subnet Mask' (input: 255 . 255 . 255 . 0), 'IPv4 Default Gateway' (input: 10 . 15 . 2 . 254), 'MAC Address' (input: a4:14:37:aa:09:a3), 'MTU(Bytes)' (input: 1500), 'Main NIC' (dropdown: LAN1), 'Enable Obtain DNS...' (checkbox: unchecked), 'Preferred DNS Server' (input field), and 'Alternate DNS Server' (input field). A blue 'Apply' button is located at the bottom left.

Figure 3-5 Network Settings

Step 2 Select the **General** tab.

Step 3 In the **General Settings** interface, you can configure the following settings: NIC Type, IPv4 Address, IPv4 Gateway, MTU, and DNS Server.

Step 4 If the DHCP server is available, you can check **DHCP** to automatically obtain an IP address and other network settings from that server.

Step 5 After having configured the general settings, click the **Apply** button to save the settings.

3.7 Add IP Cameras

Purpose:

Before you view live video or record video files, you must add network cameras to the device.

Before You Start:

Ensure the network connection is valid and the IP camera has been activated.

Step 1 Click  on the main menu.

Step 2 Click **Custom Add**.

Step 3 Set **IP Camera Address**, **Protocol**, **Management Port**, **Transfer Protocol**, **User Name**, and **Password**. **Management Port** ranges from 1 to 65535.

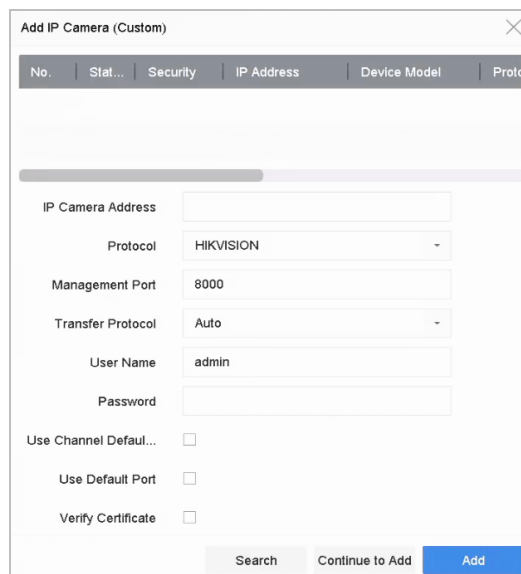

Figure 3-6 Add IP Camera

Step 4 (Optional) Check **Use Channel Default Password** to use the default password to add the camera.

Step 5 (Optional) Check **Use Default Port** to use the default management port to add the camera. For SDK service, the default port value is 8000. For enhanced SDK service, the default value is 8443.



NOTE

The function is only available when you use HIKVISION protocol.

Step 6 (Optional) Check **Verify Certificate** to verify the camera with certificate. The certificate is a form of identification for the camera that provides more secure camera authentication. It requires to import the IP camera certificate to the NVR first when you use this function.

- 1) Log in the IP camera by web browser.
- 2) Go to **Configuration > Network > Advanced Settings > HTTPS** on the web browser to export its certificate.
- 3) Click **Export** at **Export Certificate** to save the certificate.
- 4) Log in the NVR by web browser.
- 5) Go to **Configuration > System > Security > Trusted Root Certification Authorities > Import**
- 6) Click **Import** to import the IP camera certificate.



NOTE

The function is only available when you use HIKVISION protocol.

Step 7 Click **Add** to finish adding the IP camera.

Step 8 (Optional) Click **Continue to Add** to continue to add other IP cameras.

3.8 Start Live View

Enter the live view mode (.

- Select a window and double click a camera from the list to play the video from the camera in the selected window.
- Use the toolbar at the playing window bottom to realize the capture, instant playback, audio on/off, digital zoom, live view strategy, show information, start/stop recording, etc.

3.9 One-Touch RAID Configuration



NOTE

The RAID is supported by DS-9600NI-I8 and DS-9600NI-I16 Series NVRs only.

The device supports the RAID storage function. Through one-touch configuration, you can quickly create the disk array. By default, the array type to be created is RAID 5.

Before You Start

- Enable RAID function.

- Install at least 3 HDDs. If more than 10 HDDs are installed, 2 arrays will be created. To maintain reliable and stable running of the HDDs, it is recommended to use enterprise-level HDDs with the same model and capacity.

Step 1 Go to **Storage > RAID Setup > Physical Disk**.

No	Capacity	Array	Type	Status	Model	Hot Spare	Task
<input type="checkbox"/> 1	1863.02GB		Normal	Functional	ST2000VX000-1CU164		None
<input type="checkbox"/> 5	1863.02GB		Normal	Functional	ST2000VX000-1CU164		None

Figure 3-7 Physical Disk

Step 2 Click **One-touch Config**.

Step 3 Edit the array name in **Array Name** text field and click **OK** to start configuring.

NOTE

If you install 4 or more HDDs, a hot spare disk for array rebuilding will be created.

Step 4 A message box will pop up when the array creation is completed, click **OK** on it.

Step 5 Optionally, the device will automatically initialize the created array. Go to **Storage > RAID Setup > Array** view the information of created array.

3.10 Recording Settings

Before You Start

Make sure that the disk has already been installed or added. If not, install or add a disk and initialize it. Refer to the user manual for detailed information.

Option 1:

In the live view mode, select a connected camera window and click the icon on the toolbar to start recording.

Option 2:

Step 1 Go to **Storage > Recording Schedule**.

Step 2 Select a camera.

Step 3 Check the **Enable Schedule**.

Step 4 Select a **Record Type**. The record type can be Continuous, Motion Detection, Alarm, Motion | Alarm, Motion & Alarm, Event, etc.

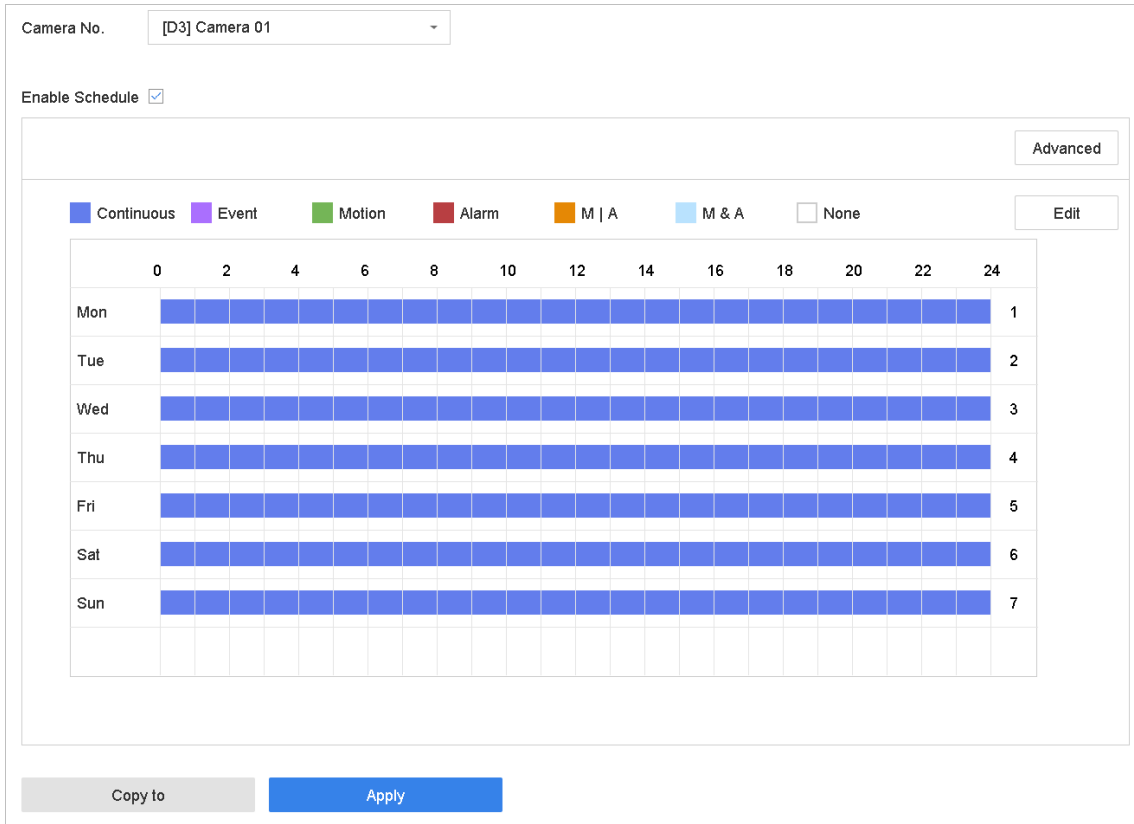

Figure 3-8 Record Schedule

Step 5 Select a day and click-and-drag the mouse on the time bar to set the record schedule.

Step 6 Click **Apply** to save the settings.

3.11 Playback

The recorded video files on the hard disk can be played back in the following modes: instant playback, all-day playback for the specified channel, and playback by normal/smart/custom /sub-periods/external file. Refer to the *User Manual* for detailed information.



Step 1 Enter the playback mode ().

Step 2 Check the channel(s) in the list and then double-click to select a date on the calendar.

Step 3 You can use the toolbar in the bottom part of Playback interface to control playing progress.

Network Video Recorder Quick Start Guide



Figure 3-9 Playback Interface

Chapter 4 Access by Web Browser

 **NOTE**

You shall acknowledge that the use of the product with Internet access might be under network security risks. For avoidance of any network attacks and information leakage, strengthen your own protection. If the product does not work properly, please contact with your dealer or the nearest service center.

Purpose:

You can get access to the device via Web browser. You may use one of the following Web browsers: Internet Explorer 6.0, Internet Explorer 7.0, Internet Explorer 8.0, Internet Explorer 9.0, Internet Explorer 10.0, Apple Safari, Mozilla Firefox, and Google Chrome. The supported resolutions include 1024*768 and above.

Step 1 Open Web browser, input the IP address of the device, and then press Enter.

Step 2 Log in to the device.

- If the device has not been activated, you need to activate the device first before login.

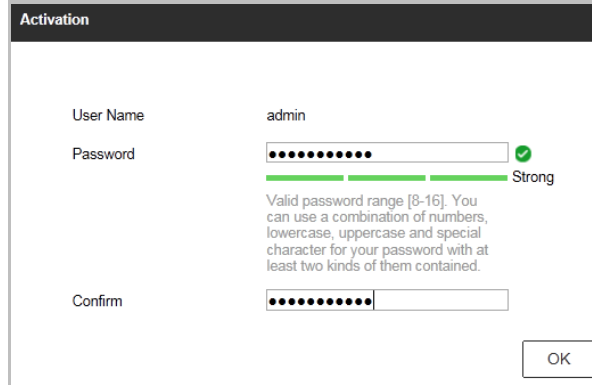

The screenshot shows a web browser window titled "Activation". It contains a form with the following fields and elements:

- User Name:** A text input field containing the text "admin".
- Password:** A password input field with a green checkmark icon to its right. Below the field is a green progress bar and the word "Strong".
- Confirm:** A second password input field with a green checkmark icon to its right.
- Instructions:** Text below the password fields reads: "Valid password range [8-16]. You can use a combination of numbers, lowercase, uppercase and special character for your password with at least two kinds of them contained."
- OK Button:** A button labeled "OK" is located at the bottom right of the form.

Figure 4-1 Set Admin Password

- 1) Set the password for the admin user account.
- 2) Click **OK** to log in to the device.

 **WARNING**

STRONG PASSWORD RECOMMENDED– We highly recommend that you create a strong password of your own choosing (using a minimum of 8 characters, including upper case letters, lower case letters, numbers, and special characters) in order to increase the security of your product. We also recommend that you reset your password regularly. Especially in the high security systems, resetting the password monthly or weekly can better protect your product.

- If the device is already activated, enter the user name and password in the login interface, and click the **Login** button.

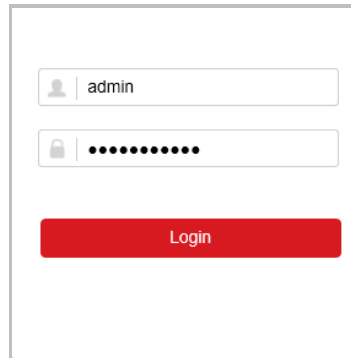

The image shows a login form with two input fields and a button. The first field is for the username, containing the text 'admin'. The second field is for the password, represented by a series of dots. Below the fields is a prominent red button labeled 'Login'.

Figure 4-2 Login

Step 3 Install the plug-in before viewing the live video and managing the camera. Follow the installation prompts to install the plug-in.

 **NOTE**

You may have to close the Web browser to finish plug-in installation.

After login, you can perform the operation and configuration of the device, including the live view, playback, log search, configuration, etc.

