



Explosion-proof Dome

Quick Start Guide

Quick Start Guide

© 2021 Hangzhou Hikvision Digital Technology Co., Ltd. All rights reserved.

This Manual is the property of Hangzhou Hikvision Digital Technology Co., Ltd. or its affiliates (hereinafter referred to as “Hikvision”), and it cannot be reproduced, changed, translated, or distributed, partially or wholly, by any means, without the prior written permission of Hikvision. Unless otherwise expressly stated herein, Hikvision does not make any warranties, guarantees or representations, express or implied, regarding to the Manual, any information contained herein.

About this Manual

The Manual includes instructions for using and managing the Product. Pictures, charts, images and all other information hereinafter are for description and explanation only. The information contained in the Manual is subject to change, without notice, due to firmware updates or other reasons. Please find the latest version of this Manual at the Hikvision website (<http://www.hikvision.com>).

Please use this Manual with the guidance and assistance of professionals trained in supporting the Product.

Trademarks Acknowledgement

- **HIKVISION** and other Hikvision’s trademarks and logos are the properties of Hikvision in various jurisdictions.
- Other trademarks and logos mentioned are the properties of their respective owners.

LEGAL DISCLAIMER

TO THE MAXIMUM EXTENT PERMITTED BY APPLICABLE LAW, THIS MANUAL AND THE PRODUCT DESCRIBED, WITH ITS HARDWARE, SOFTWARE AND FIRMWARE, ARE PROVIDED “AS IS” AND “WITH ALL FAULTS AND ERRORS”. HIKVISION MAKES NO WARRANTIES, EXPRESS OR IMPLIED, INCLUDING WITHOUT LIMITATION, MERCHANTABILITY, SATISFACTORY QUALITY, OR FITNESS FOR A PARTICULAR PURPOSE. THE USE OF THE PRODUCT BY YOU IS AT YOUR OWN RISK. IN NO EVENT WILL HIKVISION BE LIABLE TO YOU FOR ANY SPECIAL, CONSEQUENTIAL, INCIDENTAL, OR INDIRECT DAMAGES, INCLUDING, AMONG OTHERS, DAMAGES FOR LOSS OF BUSINESS PROFITS, BUSINESS INTERRUPTION, OR LOSS OF DATA, CORRUPTION OF SYSTEMS, OR LOSS OF DOCUMENTATION, WHETHER BASED ON BREACH OF CONTRACT, TORT (INCLUDING NEGLIGENCE), PRODUCT LIABILITY, OR OTHERWISE, IN CONNECTION WITH THE USE OF THE PRODUCT, EVEN IF HIKVISION HAS BEEN ADVISED OF THE POSSIBILITY OF SUCH DAMAGES OR LOSS.

YOU ACKNOWLEDGE THAT THE NATURE OF INTERNET PROVIDES FOR INHERENT SECURITY RISKS, AND HIKVISION SHALL NOT TAKE ANY RESPONSIBILITIES FOR ABNORMAL OPERATION, PRIVACY LEAKAGE OR OTHER DAMAGES RESULTING FROM CYBER-ATTACK, HACKER ATTACK, VIRUS INSPECTION, OR OTHER INTERNET SECURITY RISKS; HOWEVER, HIKVISION WILL PROVIDE TIMELY TECHNICAL SUPPORT IF REQUIRED.

YOU AGREE TO USE THIS PRODUCT IN COMPLIANCE WITH ALL APPLICABLE LAWS, AND YOU ARE SOLELY RESPONSIBLE FOR ENSURING THAT YOUR USE CONFORMS TO THE APPLICABLE LAW. ESPECIALLY, YOU ARE RESPONSIBLE, FOR USING THIS PRODUCT IN A MANNER THAT DOES NOT INFRINGE ON THE RIGHTS OF THIRD PARTIES, INCLUDING WITHOUT LIMITATION, RIGHTS OF PUBLICITY, INTELLECTUAL PROPERTY RIGHTS, OR DATA PROTECTION AND OTHER PRIVACY RIGHTS. YOU SHALL NOT USE THIS PRODUCT FOR ANY PROHIBITED END-USES, INCLUDING THE DEVELOPMENT OR PRODUCTION OF WEAPONS OF MASS DESTRUCTION, THE DEVELOPMENT OR PRODUCTION OF CHEMICAL OR BIOLOGICAL WEAPONS, ANY ACTIVITIES IN THE CONTEXT RELATED TO ANY NUCLEAR EXPLOSIVE OR UNSAFE NUCLEAR FUEL-CYCLE, OR IN SUPPORT OF HUMAN RIGHTS ABUSES.

IN THE EVENT OF ANY CONFLICTS BETWEEN THIS MANUAL AND THE APPLICABLE LAW, THE LATER PREVAILS.

05070120210518

Regulatory Information

FCC Information

Please take attention that changes or modification not expressly approved by the party responsible for compliance could void the user's authority to operate the equipment.

FCC compliance: This equipment has been tested and found to comply with the limits for a Class A digital device, pursuant to part 15 of the FCC Rules. These limits are designed to provide reasonable protection against harmful interference when the equipment is operated in a commercial environment. This equipment generates, uses, and can radiate radio frequency energy and, if not installed and used in accordance with the instruction manual, may cause harmful interference to radio communications. Operation of this equipment in a residential area is likely to cause harmful interference in which case the user will be required to correct the interference at his own expense.

FCC Conditions

This device complies with part 15 of the FCC Rules. Operation is subject to the following two conditions:

1. This device may not cause harmful interference.
2. This device must accept any interference received, including interference that may cause undesired operation.

EU Conformity Statement



This product and - if applicable - the supplied accessories too are marked with "CE" and comply therefore with the applicable harmonized European standards listed under the EMC Directive 2014/30/EU, the RoHS Directive 2011/65/EU and the ATEX Directive 2014/34/EU.



2012/19/EU (WEEE directive): Products marked with this symbol cannot be disposed of as unsorted municipal waste in the European Union. For proper recycling, return this product to your local supplier upon the purchase of equivalent new equipment, or dispose of it at designated collection points.

For more information see: www.recyclethis.info.



2006/66/EC (battery directive): This product contains a battery that cannot be disposed of as unsorted municipal waste in the European Union. See the product documentation for specific battery information. The battery is marked with this symbol, which may include lettering to indicate cadmium (Cd), lead (Pb), or mercury (Hg). For proper recycling, return the battery to your supplier or to a designated collection point. For more information see: www.recyclethis.info.

Industry Canada ICES-003 Compliance

This device meets the CAN ICES-3 (A)/NMB-3(A) standards requirements.

Warning:

This is a class A product. In a domestic environment this product may cause radio interference in which case the user may be required to take adequate measures.

Intended Use of the Dome

ATEX:  II 2GD Ex db IIC T6 Gb /Ex tb IIIC T80°C Db IP68

IECEX: Ex db IIC T6 Gb /Ex tb IIIC T80°C Db IP68

Hazardous Area Classification: Zone 1, Zone 2, Zone 21, Zone 22

IP Degree: IP68 (2m, 2h)

Ex Standards:

IEC 60079-0: 2011 EN 60079-0: 2012

IEC 60079-1: 2014 EN 60079-1: 2014

IEC 60079-31: 2013 EN 60079-31: 2014

Special Conditions for Safe Use

1. Ambient temperature: -40°C - +60°C
2. DO NOT OPEN WHEN ENERGIZED
3. POTENTIAL ELECTROSTATIC CHARGING HAZARD – SEE INSTRUCTIONS
4. When assembly, operation and maintenance, the operator must follow the requirements of the IEC 60079-14: latest version Explosive atmospheres- Part 14: Electrical installations design, selection and erection, beside of the manufacturer's operating instructions or its National equivalent.
5. Repair and overhaul shall comply with IEC 60079-19: latest version or its National equivalent.

Explosion-proof Dome Nameplate

<h1>Explosion-proof Dome</h1>	
Product Model:	
Protection Level: IP68(2m/2h) Temperature: -40°C~ +60°C	
Working Voltage: AC100-240V Working Current: ≤1000mA	
Product No.:	Date of Production:
Explosion-Proof Sign:	Explosion-Proof Certificate No.:
 II 2 G Ex db IIC T6 Gb	TÜV 16 ATEX 7950X
 II 2 D Ex tb IIIC T80°C Db	IECEX TUR 16.0050X 
WARNING: DO NOT OPEN WHEN ENERGIZED POTENTIAL ELECTROSTATIC CHARGING HAZARD-SEE INSTRUCTIONS	
CAUTION : USE FASTENERS WITH YIELD STRENGTH ≥450MPa	
Hangzhou Hikvision Digital Technology Co., Ltd.	
No.555 Qianmo Road, Binjiang District, Hangzhou , China	



Safety Instruction

These instructions are intended to ensure that user can use the product correctly to avoid danger or property loss.

The precaution measure is divided into **Warnings** and **Cautions**:

Warnings: Neglecting any of the warnings may cause serious injury or death.

Cautions: Neglecting any of the cautions may cause injury or equipment damage.

	
Warnings Follow these safeguards to prevent serious injury or death.	Cautions Follow these precautions to prevent potential injury or material damage.



Warnings

- Grounding: The both internal and external earthing shall be connected reliably.
- All the electronic operation should be strictly compliance with the electrical safety regulations, fire prevention regulations and other related regulations in your local region.
- Make sure that the power has been disconnected before you wire, install or disassemble the speed dome. Never wire, install or disassemble the speed dome in explosive environment.
- To avoid fire danger caused by electrostatic charge, never touch or wipe the speed dome in explosive environment. Perform the wiping and replacing accessories only under non-explosive environment with the provided glove.
- When the speed dome is installed on wall or ceiling, the device shall be firmly fixed.
- If smoke, odors or noise rise from the speed dome, turn off the power at once and unplug the power cable, and then contact the service center.
- If the speed dome does not work properly, contact your dealer or the nearest service center. Never attempt to disassemble the speed dome yourself. (We shall not assume any responsibility for problems caused by unauthorized repair or maintenance.)



Cautions

- If the camera fails to synchronize local time with that of the network, you need to set up camera time manually. Visit the camera (via web browser or client software) and enter system settings interface for time settings.

- Do not drop the speed dome or subject it to physical shock, and do not expose it to high electromagnetism radiation. Avoid installation on vibrations surface or places subject to shock (ignorance can cause device damage).
- To ensure explosion-proof performance, do not damage explosion-proof surface.
- Do not place the speed dome in extremely hot (refer to the specification of the device for the detailed operating temperature), cold, dusty or damp locations, and do not expose it to high electromagnetic radiation.
- The dome cover for indoor use shall be kept from rain and moisture.
- Exposing the speed dome to direct sun light, low ventilation or heat source such as heater or radiator is forbidden (ignorance can cause fire danger).
- Do not aim the speed dome at the sun or extra bright places. A blooming or smear may occur otherwise (which is not a malfunction however), and affecting the endurance of sensor at the same time.
- Use the provided glove when open up the dome cover, and avoid direct contact with the dome cover, because the acidic sweat of the fingers may erode the surface coating of the dome cover.
- To prevent accumulation of electrostatic charge, use a soft and damp cloth when clean inside and outside surfaces of the bubble. Do not use alkaline detergents.
- Keep all wrappers after unpack them for future use. In case of any failure occurred, you need to return the speed dome to the factory with the original wrapper. Transportation without the original wrapper may result in damage on the speed dome and lead to additional costs.
- This equipment is not suitable for use in locations where children are likely to be present.
- Do not dispose of the battery into fire or a hot oven, or mechanically crush or cut the battery, which may result in an explosion.
- Do not leave the battery in an extremely high temperature surrounding environment, which may result in an explosion or the leakage of flammable liquid or gas.
- Do not subject the battery to extremely low air pressure, which may result in an explosion or the leakage of flammable liquid or gas.
- Improper use or replacement of the battery may result in hazard of explosion. Replace with the same or equivalent type only. Dispose of used batteries according to the instructions provided by the battery manufacturer.
L'utilisation ou le remplacement inadéquats de la pile peuvent entraîner un risque d'explosion. Remplacez-la par le même type ou l'équivalent du même type seulement. Jetez les piles usagées conformément aux directives fournies par le fabricant de la pile.

Table of Contents

1 Overview	1
1.1 Explanation of model naming.....	1
1.2 Power Supply	2
1.3 Explosion-proof Parameters	2
1.4 Mechanical Specification	2
1.5 Working Environment	2
2 Installation	3
2.1 Preparation	3
2.1.1 Basic Requirement.....	3
2.1.2 Checking Installing Environment	3
2.1.3 Preparing Cables	3
2.1.4 Preparing Tools.....	3
2.1.5 Original Packaging	3
2.1.6 Run the Device in Safe Area	3
2.2 Cable Description and Routing	4
2.3 Installing the Explosion-proof Dome.....	5
2.3.1 Disconnecting the Cables.....	5
2.3.2 Wall Mounting	6
2.3.3 Pendant Mounting	8
2.3.4 Cable Entry Installation.....	11
2.4 Protective Measures for Outdoor Installation	12
3 Setting the Speed Dome over the LAN	13
3.1 Wiring.....	13
3.2 Activating the Speed Dome.....	13
3.2.1 Activation via Web Browser	14
3.2.2 Activation via SADP Software	15
3.3 Modifying the IP Address	16
4 Accessing via Web Browser	17

1 Overview

The explosion-proof dome captures high quality colored images in dim light environment with its low illumination and offers more details over expansive areas. It is equipped with explosion-proof enclosure made of stainless steel. It can be widely used in places such as port, wharf, petrochemical industry, and military industry.

1.1 Explanation of model naming

The product can be named by rules of Figure 1-1 and Figure 1-2.

DS - FB52 X X - XX

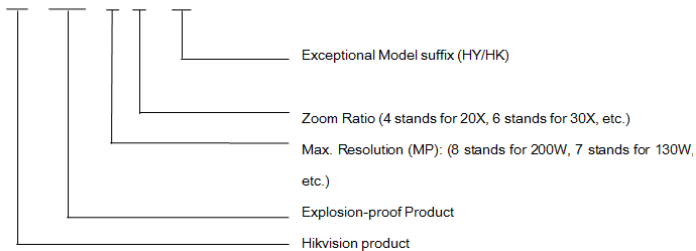

Figure 1-1 Product Naming Rule 1

DS -2DF X X XX X X X

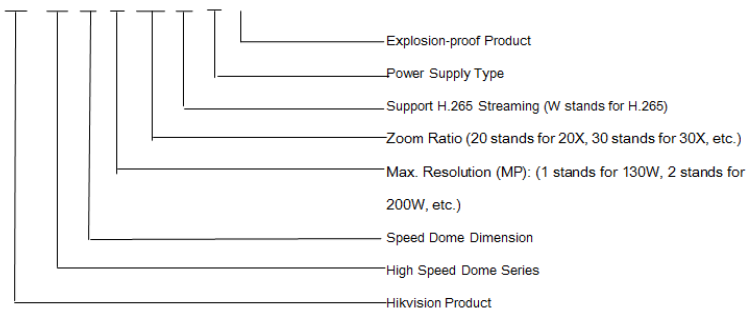

Figure 1-2 Product Naming Rule 2

1.2 Power Supply

For detailed information about the power supply, refer to *Explosion-proof Dome Nameplate*.

1.3 Explosion-proof Parameters

For detailed information about explosion-proof parameters, refer to *Explosion-proof Dome Nameplate*.

1.4 Mechanical Specification

- Material: 304/316L Stainless Steel.
- Cable outlet: One G 3/4 explosion-proof cable outlet, inner hole diameter $\Phi 15$.

1.5 Working Environment

- Altitude (Above sea level): Within 2000 m.
- Humidity: Within 95%.
- Temperature: Refer to *Explosion-proof Dome Nameplate*.

Note:

To ensure safety of the users and explosion-proof performance of the speed dome, your installation environment must meet the installation requirements of the speed dome you purchased.

2 Installation

2.1 Preparation

2.1.1 Basic Requirement

- All the electronic operation should be in strictly compliance with the electrical safety regulations, fire prevention regulations and other related regulations in your local region.
- Make sure the device in the package is in good condition and all the assembly parts are included.

2.1.2 Checking Installing Environment

- Make sure that there is enough space to install the device and accessories.
- Make sure that the wall is strong enough to withstand at least eight times the weight of the device and accessories.

2.1.3 Preparing Cables

You should prepare proper cables according to the actual network bandwidth, transmission distance and installation environment:

- Network Cable
- Power Cord

2.1.4 Preparing Tools

Before installation, prepare the tools, such as the expansion screws, electric hammer, electric drill, wrench, screwdriver, electroprobe, and network cable.

2.1.5 Original Packaging

When you unpack the device, keep the original package properly, in case of returning or repairing the camera, you can pack the device with the package.

Note:

The user should be responsible for any damage caused due to transporting in unoriginal package.

2.1.6 Run the Device in Safe Area

It is recommended to trial run the device in the safe area before installation.

Steps:

1. Make sure the power cable and network cable are connected properly. Then power on the device to trial run the device.

2. Check if the device performs power-up action. If not, contact the technical support.
Normally, the power-up action should include the device movement of automatically panning and tilting.
3. Check if the image can be displayed normally. If not, contact the technical support.
4. Start the installation after making sure the device works properly.

Note:

If the speed dome cannot be powered up, check the cable connection carefully.

2.2 Cable Description and Routing

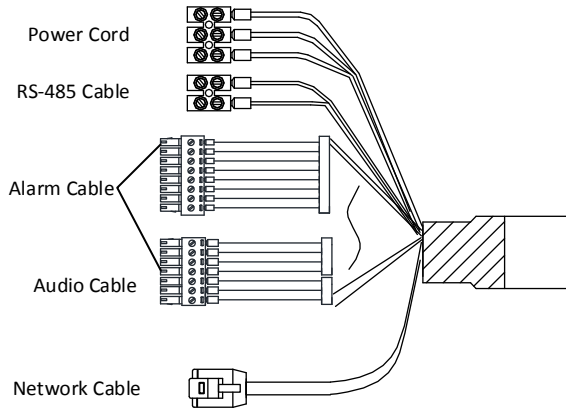

Figure 2-1 Cable Description

Notes:

- The cables vary depending on different speed dome models.
- The three cables of the power cord should be connected to corresponding wires. The red cable should be connected to live wire. The black cable should be connected to neutral wire. The yellow/green cable must be connected to the ground.
- For power cord, refer to the nameplate for the voltage standard. To avoid transmitting interference, route power cables separately.

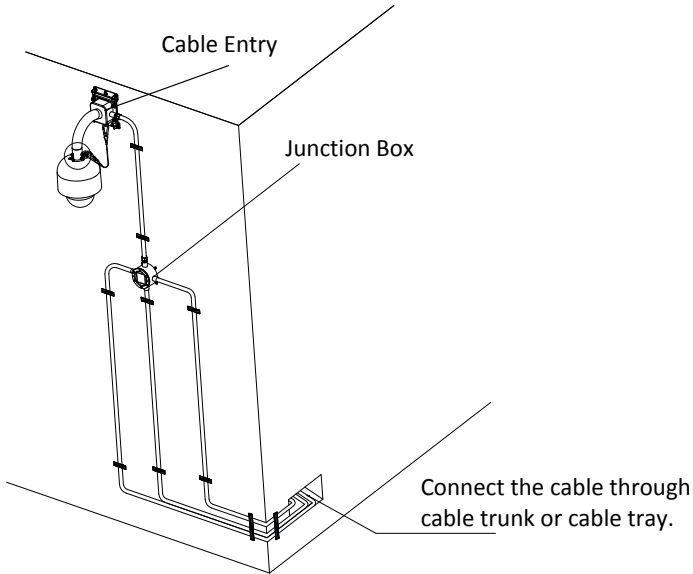

Figure 2-2 Cable Wiring Diagram

2.3 Installing the Explosion-proof Dome

Before you start:

Check the package contents and make sure that the device in the package is in good condition and all the assembly parts are included.

We highly recommend that before installation, you apply power to the speed dome to test it and make sure it can work normally.

Notes:

- Do not drag the speed dome with its waterproof cables. The waterproof performance is affected otherwise.
- Do not touch the bubble directly by hand. The image blurs otherwise.
- All installation operations shall be performed when the speed dome is powered off.
- Do not disassemble the speed dome.

2.3.1 Disconnecting the Cables

After testing the speed dome, disconnect the cables as shown in Figure 2-3.

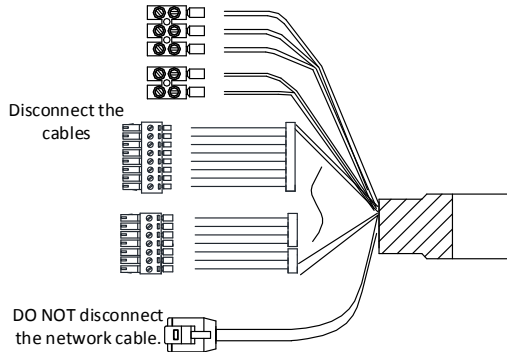

Figure 2-3 Disconnecting the cables

2.3.2 Wall Mounting

Before you start:

- Make sure that the wall is thick enough to withstand the expansion screws.
- Make sure that the wall is strong enough to withstand more than eight times the weight of the dome and the accessories.
- There must be enough space for installing the explosion-proof dome and its accessories.
- Make sure the speed dome is power off before connecting the cables.

Steps:

1. Drill four screw holes for $\phi 16$ expansion screws in the wall, and fix the installation plate onto the wall by inserting the four M12 \times 130 expansion screws into the wall.

Make sure that  mark is upward.

2. Insert the flag washer and the spring washer. Then tighten the four screws to secure the installation plate as shown in Figure 2-4.

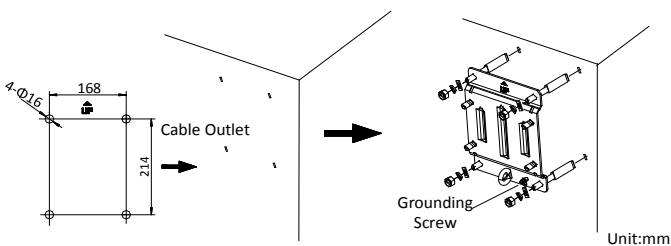

Figure 2-4 Install the Installation Plate

3. Route the cables into the bracket body. Insert three preassemble screws into the preassemble screw holes on the cable joint (do not tighten the preassemble screws) as shown in Figure 2-5.

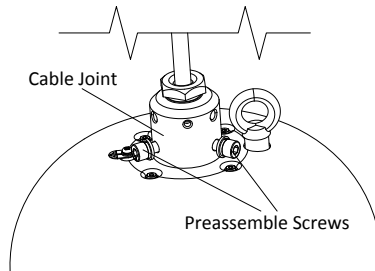

Figure 2-5 Insert the Screws

4. Align the bracket with the cable joint and rotate the bracket clockwise until three preassemble screws on the cable joint hooks onto three slots on the bracket as shown in Figure 2-6.

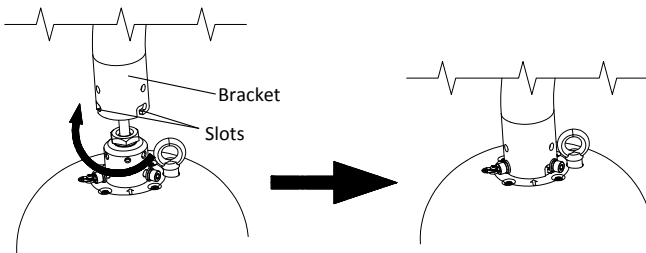

Figure 2-6 Rotate the Bracket

5. Screw three fixing screws into the fixing screws holes on the bracket. Then tighten three preassemble screws to secure the speed dome as shown in Figure 2-7.

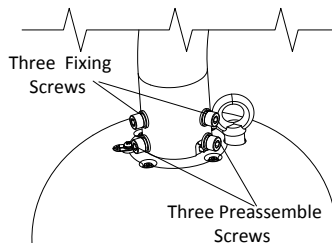

Figure 2-7 Secure the Speed Dome

6. Install the bracket to the installation plate.

- 1) Hang the safety rope to the speed dome and the hook on the bracket.
- 2) Route the cables of the speed dome through the bracket and connect the corresponding cables.
- 3) Hang the speed dome to the bracket by aligning the holes of bracket with the screws and move the speed dome downward to secure the speed dome as shown as Figure 2-8.

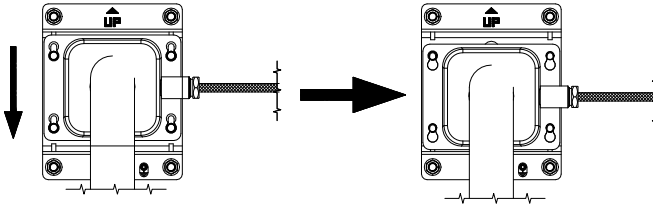

Figure 2-8 Install Bracket to Installation Plate

7. Secure the bracket by putting in the flat washer and the spring washer. Then tighten the gland nut.

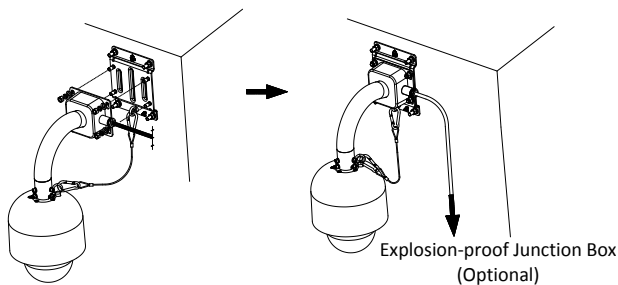

Figure 2-9 Secure the Bracket

8. Remove the protective film on the bubble after the installation is finished.

2.3.3 Pendant Mounting

Before you start:

- Make sure the ceiling is thick enough to withstand the expansion screws.
- Make sure the ceiling must be strong enough to withstand more than eight times the weight of the dome and its accessories.
- There must be enough space for installing the explosion-proof dome and its accessories.
- Make sure the speed dome is power off before connecting the cables.

Steps:

1. Drill four screw holes for $\phi 16$ expansion screws in the wall, and fix the installation plate onto the wall by inserting the four M12 \times 130 expansion screws into the wall.

Make sure that  mark is at the cable outlet and is upward.

2. Insert the flag washer and the spring washer. Then tighten the four screws to secure the installation plate as shown in Figure 2-10.

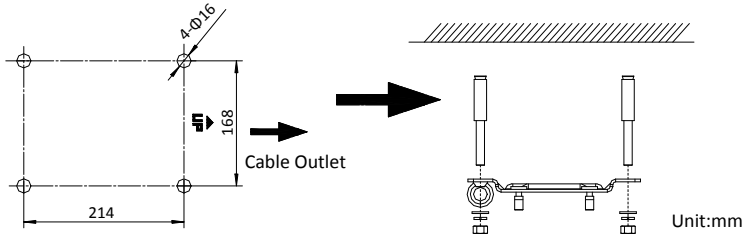

Figure 2-10 Install the Installation Plate

3. Route the cables into the bracket body. Insert three preassemble screws into the preassemble screw holes on the cable joint (do not tighten the preassemble screws) as shown in Figure 2-11.

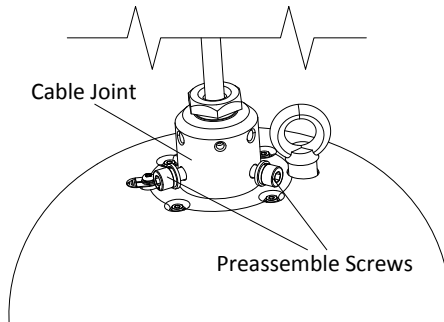

Figure 2-11 Insert the Screws

4. Align the bracket with the cable joint and rotate the bracket clockwise until three preassemble screws on the cable joint hooks onto three slots on the bracket as shown in Figure 2-12.

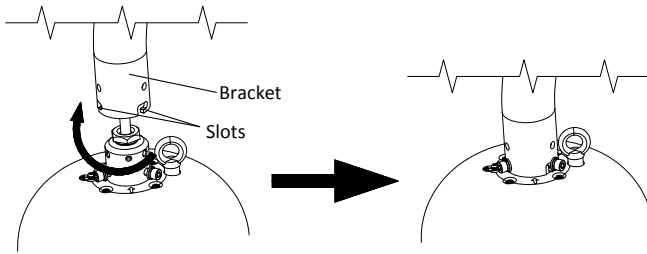

Figure 2-12 Rotate the Bracket

5. Screw three fixing screws into the fixing screws holes on the bracket. Then tighten three preassemble screws to secure the speed dome as shown in Figure 2-13.

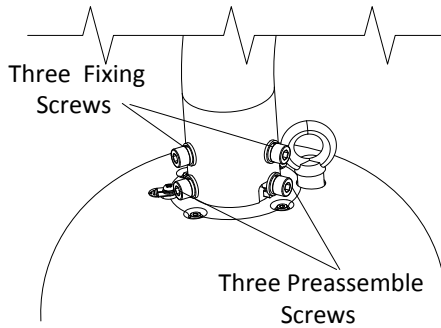

Figure 2-13 Secure the Speed Dome

6. Install the bracket to the installation plate.
 - 1) Hang the safety rope to the speed dome and the hook on the bracket.
 - 2) Route the cables of the speed dome through the bracket and connect the corresponding cables.
 - 3) Hang the speed dome to the bracket by aligning the holes of bracket with the screws and move the speed dome following the direction in Figure 2-14 to secure the speed dome.

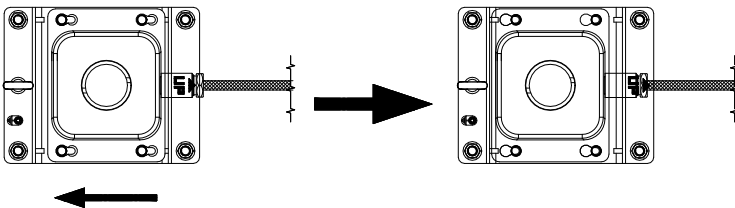

Figure 2-14 Install Bracket to Installation Plate

- Secure the bracket by putting in the flat washer and the spring washer. Then tighten the gland nut.

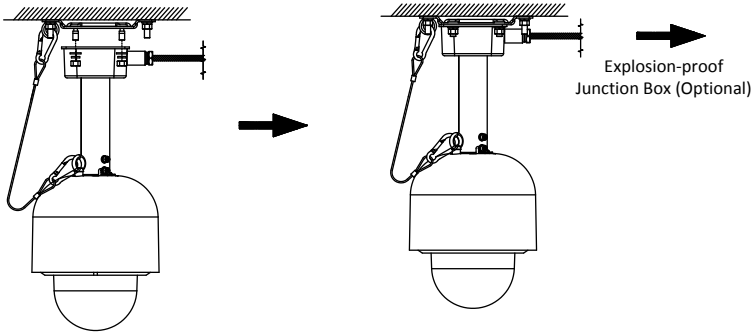

Figure 2-15 Secure the Bracket

- Remove the protective film on the bubble after the installation is finished.

2.3.4 Cable Entry Installation

Purpose:

To ensure the explosion-proof performance of the speed dome, you shall route the cable through the cable entry to protect the cables after speed dome installation.

Steps:

- Loosen and take off the gland nut of the cable entry.
- Seal the cable entry by routing the cables through the sealing ring, washer, and gland nut in order as shown in Figure 2-16.

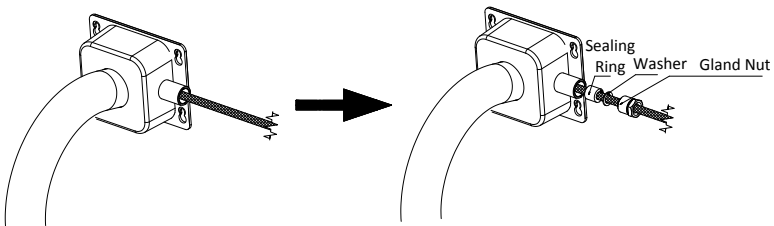

Figure 2-16 Seal the Cable Entry

- Weld the cables heads back.

2.4 Protective Measures for Outdoor Installation

If the device is installed outdoors, necessary protective measures should be taken to ensure safety. Scan the following QR code to get protective measures for outdoor installation.



3 Setting the Speed Dome over the LAN

Notes:

- You shall acknowledge that the use of the product with Internet access might be under network security risks. For avoidance of any network attacks and information leakage, strengthen your own protection. If the product does not work properly, contact with your dealer or the nearest service center.
- To ensure the network security of the speed dome, we recommend you to have the speed dome assessed and maintained termly. You can contact us if you need such service.

3.1 Wiring

To view and configure the speed dome via LAN (Local Area Network), you need to connect the network speed dome in the same subnet with your PC. Then, install the SADP or client software to search and change the IP of network speed dome.

The following figure shows the cable connection of network speed dome.

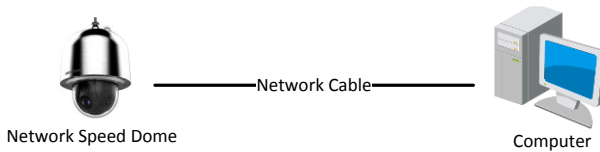

Figure 3-1 Connecting Directly

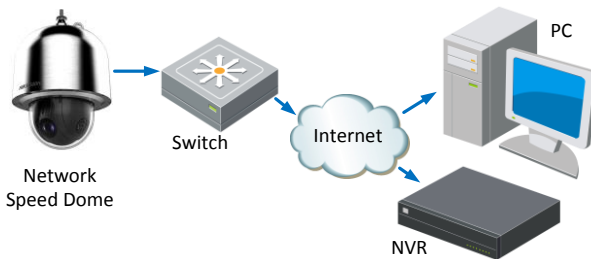

Figure 3-2 Wiring over LAN

3.2 Activating the Speed Dome

Purpose:

You are required to activate the speed dome first by setting a strong password for it before you can use the speed dome.

Activation via web browser, activation via SADP, and activation via client software are supported. We will take activation via SADP software and activation via web browser as examples to introduce the speed dome activation.

3.2.1 Activation via Web Browser

Steps:

1. Power on the speed dome. Connect the speed dome to your computer or the switch/router which your computer connects to.
2. Input the IP address into the address bar of the web browser, and enter the activation interface.

Notes:

- The default IP address of the speed dome is 192.168.1.64.
- The computer and the speed dome should belong to the same subnet.
- For the speed dome enables the DHCP by default, you need to use the SADP software to search the IP address.

The screenshot shows a web browser window titled "Activation". It contains a form with the following elements:

- User Name:** A text input field containing the text "admin".
- Password:** A password input field that is currently empty.
- Confirm:** A text input field that is currently empty.
- Instructions:** Below the Password field, there is a note: "Valid password range [8-16]. You can use a combination of numbers, lowercase, uppercase and special character for your password with at least two kinds of them contained."
- OK Button:** A button labeled "OK" is located at the bottom right of the form.

Figure 3-3 Activation Interface(Web)

3. Create a password and input the password into the password field.



STRONG PASSWORD RECOMMENDED— We highly recommend you create a strong password of your own choosing (Using a minimum of 8 characters, including at least three of the following categories: upper case letters, lower case letters, numbers, and special characters.) in order to increase the security of your product. And we recommend you reset your password regularly, especially in the high security system, resetting the password monthly or weekly can better protect your product.

4. Confirm the password.
5. Click **OK** to activate the speed dome and enter the live view interface.

3.2.2 Activation via SADP Software

SADP software is used for detecting the online device, activating the device, and resetting the password.

Get the SADP software from the supplied disk or the official website, and install the SADP according to the prompts.

Follow the steps to activate the speed dome.

Steps:

1. Run the SADP software to search the online devices.
2. Check the device status from the device list, and select an inactive device.

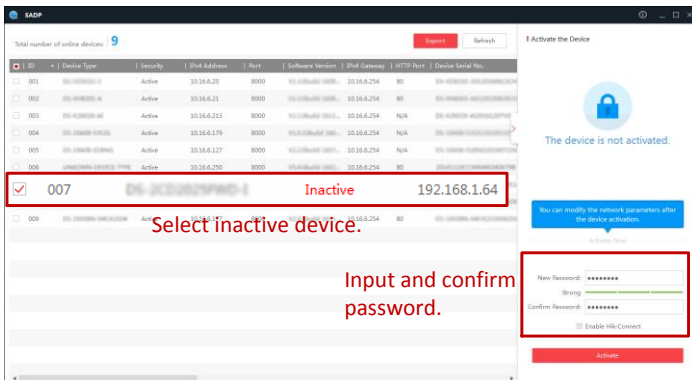

Figure 3-4 SADP Interface

Note:

The SADP software supports activating the speed dome in batch. Refer to the user manual of SADP software for details.

3. Create a password and input the password in the password field, and confirm the password.



STRONG PASSWORD RECOMMENDED– We highly recommend you create a strong password of your own choosing (Using a minimum of 8 characters, including at least three of the following categories: upper case letters, lower case letters, numbers, and special characters.) in order to increase the security of your product. And we recommend you reset your password regularly, especially in the high security system, resetting the password monthly or weekly can better protect your product.

4. Click **Activate** to save the password.

Note:

You can check whether the activation is completed on the popup window. If activation failed, make sure that the password meets the requirement and try again.

3.3 Modifying the IP Address

Purpose:

To view and configure the speed dome via LAN (Local Area Network), you need to connect the network speed dome in the same subnet with your PC.

Use the SADP software or client software to search and change the IP address of the device. We take modifying the IP Address via SADP software as an example to introduce the IP address modification.

Note:

For IP address modification via client software, refer to the user manual of client software.

Steps:

1. Run the SADP software.
2. Click to select an active device.
3. Change the device IP address to the same subnet with your computer by either modifying the IP address manually or checking the **Enable DHCP** checkbox.

Modify Network Parameters

Enable DHCP

Device Serial No.: XX-XXXXXXXX-XXXXXXXXXXXXXXXX

IP Address: 192.168.1.64

Port: 8000

Subnet Mask: 255.255.255.0

Gateway: 192.168.1.1

IPv6 Address: ::

IPv6 Gateway: ::

IPv6 Prefix Length: 0

HTTP Port: 80

Security Verification

Admin Password:

Modify

[Forgot Password](#)

Figure 3-5 Modify the IP Address

4. Input the admin password and click **Modify** to activate your IP address modification. The batch IP address modification is supported by SADP. Refer to the user manual of SADP for details.

4 Accessing via Web Browser

System Requirement:

Operating System: Microsoft Windows XP SP1 and above version/Vista Win7/Server 2003/Server 2008 32bits

CPU: Intel Pentium IV 3.0 GHz or higher

RAM: 1G or higher

Display: 1024 × 768 resolution or higher

Web Browser: Internet Explorer 8 to 11, Google Chrome 31 to 44, and Mozilla Firefox 30 to 51

Steps:

1. Open the web browser.
2. In the browser address bar, input the IP address of the network speed dome, and enter the login interface.

Note:

The default IP address is 192.168.1.64. You are recommended to change the IP address to the same subnet with your computer.

3. Input the user name and password.

The admin user should configure the device accounts and user/operator permissions properly. Delete the unnecessary accounts and user/operator permissions.

Note:

The device IP address gets locked if the admin user performs 7 failed password attempts (5 attempts for the user/operator).

4. Click **Login**.

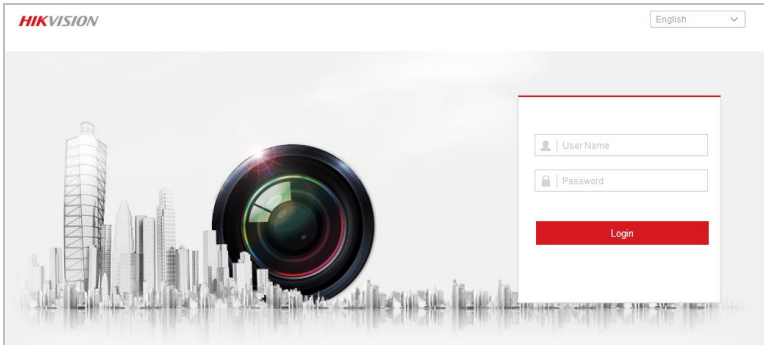

Figure 4-1 Login Interface

5. Install the plug-in before viewing the live video and managing the network speed dome. Follow the installation prompts to install the plug-in.

Note:

You may have to close the web browser to finish the installation of the plug-in.

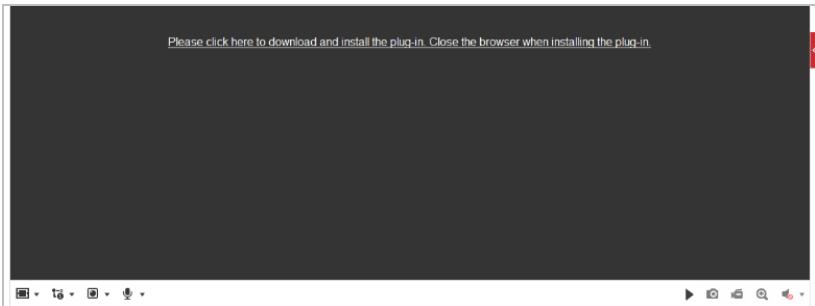

Figure 4-2 Download Plug-in

6. Reopen the web browser after the installation of the plug-in and repeat the above step 2 to step 4 to login.

Note:

For detailed instructions of further configuration, refer to the user manual of explosion-proof dome.

