

HIKVISION



Network Fisheye Camera

Quick Start Guide

UD02120B

Quick Start Guide

COPYRIGHT ©2017 Hangzhou Hikvision Digital Technology Co., Ltd.

ALL RIGHTS RESERVED.

Any and all information, including, among others, wordings, pictures, graphs are the properties of Hangzhou Hikvision Digital Technology Co., Ltd. or its subsidiaries (hereinafter referred to be “Hikvision”). This user manual (hereinafter referred to be “the Manual”) cannot be reproduced, changed, translated, or distributed, partially or wholly, by any means, without the prior written permission of Hikvision. Unless otherwise stipulated, Hikvision does not make any warranties, guarantees or representations, express or implied, regarding to the Manual.

About this Manual

This Manual is applicable to 63xx Network Camera.

The Manual includes instructions for using and managing the product. Pictures, charts, images and all other information hereinafter are for description and explanation only. The information contained in the Manual is subject to change, without notice, due to firmware updates or other reasons. Please find the latest version in the company website (<http://overseas.hikvision.com/en/>).

Please use this user manual under the guidance of professionals.

Trademarks Acknowledgement

HIKVISION and other Hikvision’s trademarks and logos are the properties of Hikvision in various jurisdictions. Other trademarks and logos mentioned below are the properties of their respective owners.

Legal Disclaimer

TO THE MAXIMUM EXTENT PERMITTED BY APPLICABLE LAW, THE PRODUCT DESCRIBED, WITH ITS HARDWARE, SOFTWARE AND FIRMWARE, IS PROVIDED "AS IS", WITH ALL FAULTS AND ERRORS, AND HIKVISION MAKES NO WARRANTIES, EXPRESS OR IMPLIED, INCLUDING WITHOUT LIMITATION, MERCHANTABILITY, SATISFACTORY QUALITY, FITNESS FOR A PARTICULAR PURPOSE, AND NON-INFRINGEMENT OF THIRD PARTY. IN NO EVENT WILL HIKVISION, ITS DIRECTORS, OFFICERS, EMPLOYEES, OR AGENTS BE LIABLE TO YOU FOR ANY SPECIAL, CONSEQUENTIAL, INCIDENTAL, OR INDIRECT DAMAGES, INCLUDING, AMONG OTHERS, DAMAGES FOR LOSS OF BUSINESS PROFITS, BUSINESS INTERRUPTION, OR LOSS OF DATA OR DOCUMENTATION, IN CONNECTION WITH THE USE OF THIS PRODUCT, EVEN IF HIKVISION HAS BEEN ADVISED OF THE POSSIBILITY OF SUCH DAMAGES.

REGARDING TO THE PRODUCT WITH INTERNET ACCESS, THE USE OF PRODUCT SHALL BE WHOLLY AT YOUR OWN RISKS. HIKVISION SHALL NOT TAKE ANY RESPONSIBILITIES FOR ABNORMAL OPERATION, PRIVACY LEAKAGE OR OTHER DAMAGES RESULTING FROM CYBER ATTACK, HACKER ATTACK, VIRUS INSPECTION, OR OTHER INTERNET SECURITY RISKS; HOWEVER, HIKVISION WILL PROVIDE TIMELY TECHNICAL SUPPORT IF REQUIRED.

SURVEILLANCE LAWS VARY BY JURISDICTION. PLEASE CHECK ALL RELEVANT LAWS IN YOUR JURISDICTION BEFORE USING THIS PRODUCT IN ORDER TO ENSURE THAT YOUR USE CONFORMS THE APPLICABLE LAW. HIKVISION SHALL NOT BE LIABLE IN THE EVENT THAT THIS PRODUCT IS USED WITH ILLEGITIMATE PURPOSES.

IN THE EVENT OF ANY CONFLICTS BETWEEN THIS MANUAL AND THE APPLICABLE LAW, THE LATER PREVAILS.

Regulatory Information

FCC Information

Please take attention that changes or modification not expressly approved by the party responsible for compliance could void the user's authority to operate the equipment.

FCC compliance: This equipment has been tested and found to comply with the limits for a Class B digital device, pursuant to part 15 of the FCC Rules. These limits are designed to provide reasonable protection against harmful interference in a residential installation. This equipment generates, uses and can radiate radio frequency energy and, if not installed and used in accordance with the instructions, may cause harmful interference to radio communications. However, there is no guarantee that interference will not occur in a particular installation. If this equipment does cause harmful interference to radio or television reception, which can be determined by turning the equipment off and on, the user is encouraged to try to correct the interference by one or more of the following measures:

- Reorient or relocate the receiving antenna.
- Increase the separation between the equipment and receiver.
- Connect the equipment into an outlet on a circuit different from that to which the receiver is connected.
- Consult the dealer or an experienced radio/TV technician for help

FCC Conditions

This device complies with part 15 of the FCC Rules. Operation is subject to the following two conditions:

1. This device may not cause harmful interference.
2. This device must accept any interference received, including interference that may cause undesired operation.

EU Conformity Statement



This product and - if applicable - the supplied accessories too are marked with "CE" and comply therefore with the applicable harmonized European standards listed under the EMC Directive 2014/30/EU, the RoHS Directive 2011/65/EU.



2012/19/EU (WEEE directive): Products marked with this symbol cannot be disposed of as unsorted municipal waste in the European Union. For proper recycling, return this product to your local supplier upon the purchase of equivalent new equipment, or dispose of it at designated collection points. For more information see: www.recyclethis.info



2006/66/EC (battery directive): This product contains a battery that cannot be disposed of as unsorted municipal waste in the European Union. See the product documentation for specific battery information. The battery is marked with this symbol, which may include lettering to indicate cadmium (Cd), lead (Pb), or mercury (Hg). For proper recycling, return the battery to your supplier or to a designated collection point. For more information see: www.recyclethis.info

Industry Canada ICES-003 Compliance

This device meets the CAN ICES-3 (B)/NMB-3(B) standards requirements.



Safety Instruction

These instructions are intended to ensure that user can use the product correctly to avoid danger or property loss.

The precaution measure is divided into “Warnings” and “Cautions”

Warnings: Serious injury or death may occur if any of the warnings are neglected.

Cautions: Injury or equipment damage may occur if any of the cautions are neglected.

	
Warnings Follow these safeguards to prevent serious injury or death.	Cautions Follow these precautions to prevent potential injury or material damage.



Warnings

- Proper configuration of all passwords and other security settings is the responsibility of the installer and/or end-user.

- In the use of the product, you must be in strict compliance with the electrical safety regulations of the nation and region. Please refer to technical specifications for detailed information.
- Input voltage should meet both the SELV (Safety Extra Low Voltage) and the Limited Power Source with 24 VAC or 12 VDC according to the IEC60950-1 standard. Please refer to technical specifications for detailed information.
- Do not connect several devices to one power adapter as adapter overload may cause over-heating or a fire hazard.
- Please make sure that the plug is firmly connected to the power socket. When the product is mounted on wall or ceiling, the device shall be firmly fixed.
- If smoke, odor or noise rise from the device, turn off the power at once and unplug the power cable, and then please contact the service center.



Cautions

- Make sure the power supply voltage is correct before using the camera.
- Do not drop the camera or subject it to physical shock.
- Do not touch sensor modules with fingers. If cleaning is necessary, use clean cloth with a bit of ethanol and wipe it gently. If the camera will not be used for an extended period, please replace the lens cap to protect the sensor from dirt.
- Do not aim the camera at the sun or extra bright places. Blooming or smearing may occur otherwise (which is not a

malfunction), and affect the endurance of sensor at the same time.

- The sensor may be burned out by a laser beam, so when any laser equipment is in using, make sure that the surface of sensor will not be exposed to the laser beam.
- Do not place the camera in extremely hot, cold (the operating temperature shall be $-30^{\circ}\text{C} \sim +60^{\circ}\text{C}$, or $-40^{\circ}\text{C} \sim +60^{\circ}\text{C}$ if the camera model has an “H” in its suffix), dusty or damp locations, and do not expose it to high electromagnetic radiation.
- To avoid heat accumulation, good ventilation is required for operating environment.
- Keep the camera away from liquid while in use.
- While in delivery, the camera shall be packed in its original packing, or packing of the same texture.
- Regular part replacement: a few parts (e.g. electrolytic capacitor) of the equipment shall be replaced regularly according to their average enduring time. The average time varies because of differences between operating environment and using history, so regular checking is recommended for all the users. Please contact with your dealer for more details.
- Improper use or replacement of the battery may result in hazard of explosion. Replace with the same or equivalent type only. Dispose of used batteries according to the instructions provided by the battery manufacturer.
- If the product does not work properly, please contact your dealer or the nearest service center. Never attempt to disassemble the camera yourself. (We shall not assume any

responsibility for problems caused by unauthorized repair or maintenance.)

0504051070216

Table of Contents

1 Appearance Description	10
1.1 Overview of Fisheye Camera	10
1.2 Disassembling the Camera	11
2 Installation	13
2.1 Ceiling Mounting	14
2.2 Wall Mounting with a Slant Mounting Base	16
2.3 Wall Mounting with a Junction Box	19
2.4 Wall Mounting with a Bracket	20
3 Setting the Network Camera over the LAN	23
3.1 Wiring	23
3.2 Activating the Camera	24
3.2.1 Activation via Web Browser	24
3.2.2 Activation via SADP Software	25
3.3 Modifying the IP Address	27
4 Accessing via Web Browser	30

1 Appearance Description

1.1 Overview of Fisheye Camera

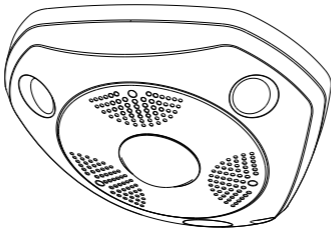

Figure 1-1 Overview of the Fisheye Camera

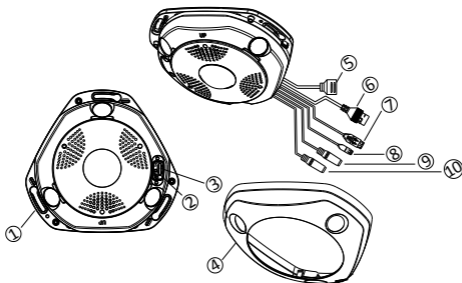

Figure 1-2 Disassemble of Fisheye Camera

Table 1-1 Description of Overview

No.	Description	No.	Description
1	Camera Body	6	Ethernet Interface
2	Reset	7	RS-485 Interface
3	Micro SD Card Slot	8	Power Interface
4	Camera Cover	9	Audio In
5	Alarm Interfaces	10	Audio Out

1.2 Disassembling the Camera

Steps:

1. Loosen the lock screw on the camera cover.
2. Remove the camera cover, and you can see the oval dismountable sheet.
3. Loosen the two screws on the dismountable part.
4. Move the oval sheet aside, and you can see the reset button and the micro SD card slot.

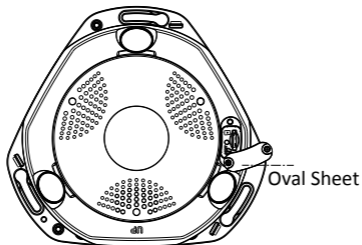

Figure 1-3 Move the Oval Sheet Aside



Press RESET about 10s when the camera is powering on or rebooting to restore the default settings, including the user name, password, IP address, port No., etc.

2 Installation

Before you start:

- Make sure the device in the package is in good condition and all the assembly parts are included.
- The standard power supply is 12V DC or 24V AC, please make sure your power supply matches with your camera.
- Make sure all the related equipment is power-off during the installation.
- Check the specification of the products for the installation environment.
- Make sure that the wall is strong enough to withstand four times the weight of the camera and the bracket.

For the camera that supports IR, you are required to pay attention to the following precautions to prevent IR reflection:

- Dust or grease on the dome cover will cause IR reflection. Please do not remove the dome cover film until the installation is finished. If there is dust or grease on the dome cover, clean the dome cover with clean soft cloth and isopropyl alcohol.
- Make sure that there is no reflective surface too close to the camera lens. The IR light from the camera may reflect back into the lens causing reflection.
- The foam ring around the lens must be seated flush against the inner surface of the bubble to isolate the lens from the IR LEDs. Fasten the dome cover to camera body so that the foam ring and the dome cover are attached seamlessly.

2.1 Ceiling Mounting

Steps:

1. Drill three screw holes and the cable hole according to the supplied drill template.

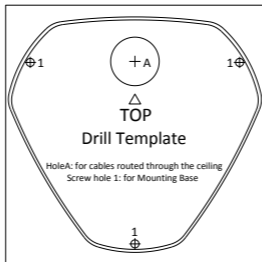

Figure 2-1 Drill Template

2. Fix the three supplied screws half-deep to the ceiling, leaving enough space to hook the camera body.

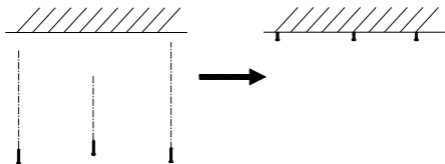

Figure 2-2 Fix the Screws

3. Connect the corresponding power cable, network cable, audio and alarm cables.
4. Align the screw holes to the inserted screws, hook the camera body to the screws, and route the camera body to secure the camera with the screws.
5. Hammer the half-deep screws into the ceiling totally.
6. Install the camera cover to the camera body, and fix them by tightening the lock screw on the camera cover.

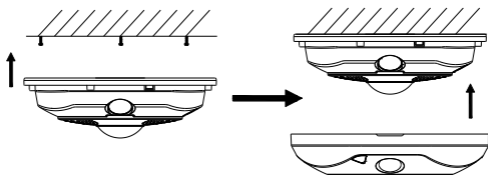

Figure 2-3 Install the Camera

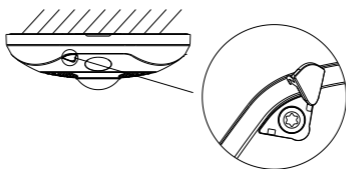

Figure 2-4 Tighten the Lock Screw on the Camera Cover

2.2 Wall Mounting with a Slant Mounting Base

The wall mounting with a slant mounting base provides a wider surveillance view compared to the wall mounting. And you need to purchase a slant mounting base separately if this mounting method is selected.

Steps:

1. Fix the slant mounting base to the wall with the screws.

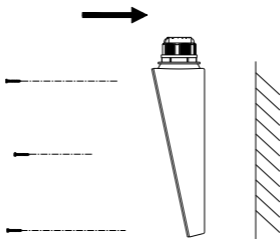

Figure 2-5 Fix the Slant Mounting Base

2. Screw the three screws half-deep to the mounting base.

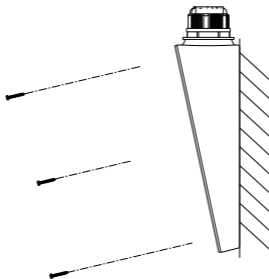

Figure 2-6 Hammer the Screws

3. Connect the corresponding power cable, network cable, audio and alarm cables.
4. Align the screw holes to the inserted screws, hook the camera body to the screws, and route the camera body to secure the camera with the screws.
5. Screw the half-deep screws into the wall totally.
6. Install the camera cover to the camera body, and fix them by tightening the lock screw on the camera cover.

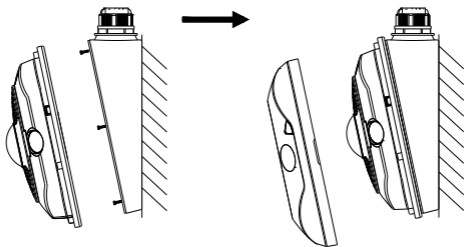

Figure 2-7 Install the Camera Body and Cover

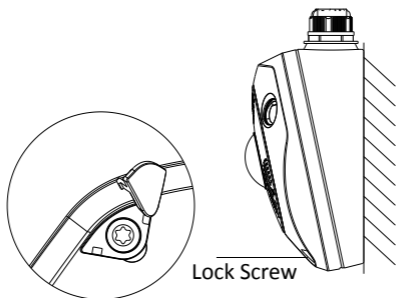

Figure 2-8 Tighten the Lock Screw on the Camera Cover

2.3 Wall Mounting with a Junction Box



You have to purchase a junction box separately if this mounting method is selected.

Steps:

1. Fix the junction box to the wall with screws.

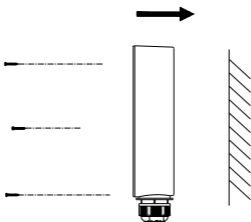

Figure 2-9 Fix the Junction Box

2. Screw the three supplied screws half-deep to the junction box.
3. Connect the corresponding power cable, network cable, audio and alarm cables.
4. Align the screw holes to the inserted screws, hook the camera body to the screws, and route the camera body to secure the camera with the screws.
5. Screw the half-deep screws into the wall totally.
6. Install the camera cover to the camera body, and fix them by tightening the screw on the camera cover.

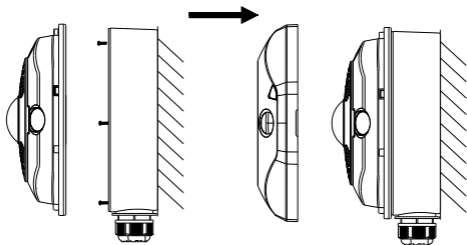

Figure 2-10 Install the Camera Body and Cover

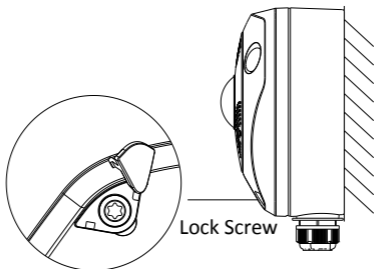

Figure 2-11 Tighten the Lock Screw on the Camera Cover

2.4 Wall Mounting with a Bracket



You have to purchase the bracket separately if this mounting method is selected.

1. Install the bracket to the wall.
2. Install the mounting base to the bracket.
3. Screw the three supplied screws half-deep to the mounting base.

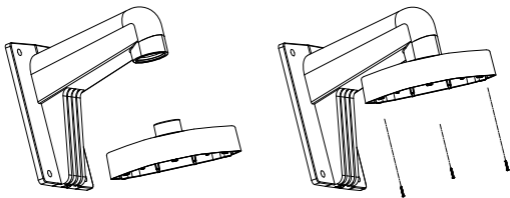

Figure 2-12 Install the Bracket

4. Connect the corresponding power cable, network cable, audio and alarm cables.
5. Align the screw holes to the inserted screws, hook the camera body to the screws, and route the camera body to secure the camera with the screws.
6. Screw the half-deep screws into the mounting base totally.
7. Install the camera cover to the camera body, and fix them by tightening the screw on the camera cover.

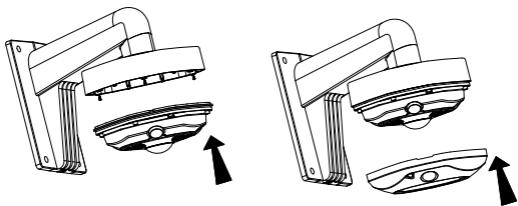

Figure 2-13 Install the Camera Body and Cover

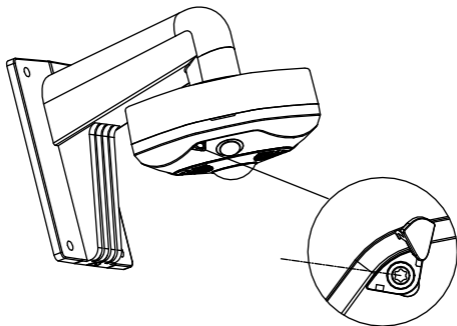

Figure 2-14 Tighten the Screw on the Camera Cover

3 Setting the Network Camera over the LAN

Note:

You shall acknowledge that the use of the product with Internet access might be under network security risks. For avoidance of any network attacks and information leakage, please strengthen your own protection. If the product does not work properly, please contact with your dealer or the nearest service center.

3.1 Wiring

Please connect to the camera to the network according to the following figures

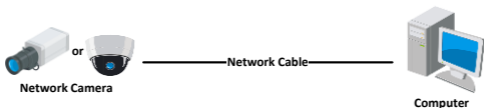

Figure 3-1 Connecting Directly

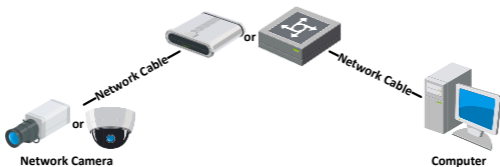

Figure 3-2 Connecting via a Switch or a Router

3.2 Activating the Camera

You are required to activate the camera first by setting a strong password for it before you can use the camera.

Activation via Web Browser, Activation via SADP, and Activation via Client Software are all supported. We will take activation via SADP software and Activation via Web Browser as examples to introduce the camera activation. Please refer to the User Manual of Network Camera for Activation via Client Software.

3.2.1 Activation via Web Browser

Steps:

1. Power on the camera. Connect the camera to your computer or the switch/router which your computer connects to.
2. Input the IP address into the address bar of the web browser, and press Enter to enter the activation interface.

Notes:

- The default IP address of the camera is 192.168.1.64.
- The computer and the camera should belong to the same subnet.
- For the camera enables the DHCP by default, you need to use the SADP software to search the IP address.

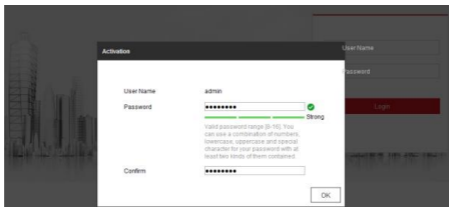

Figure 3-3 Activation Interface(Web)

3. Create a password and input the password into the password field.



STRONG PASSWORD RECOMMENDED– *We highly recommend you create a strong password of your own choosing (using a minimum of 8 characters, including upper case letters, lower case letters, numbers, and special characters) in order to increase the security of your product. And we recommend you reset your password regularly, especially in the high security system, resetting the password monthly or weekly can better protect your product.*

4. Confirm the password.
5. Click **OK** to save the password and enter the live view interface.

3.2.2 Activation via SADP Software

SADP software is used for detecting the online device, activating the camera, and resetting the password.

Network Fisheye Camera ▪ Quick Start Guide

Get the SADP software from the supplied disk or the official website, and install the SADP according to the prompts. Follow the steps to activate the camera, please refer to the User Manual of Network Camera for other two activation methods.

Steps:

1. Run the SADP software to search the online devices.
2. Check the device status from the device list, and select the inactive device.

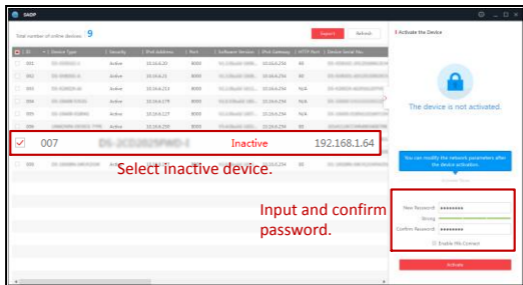

Figure 3-4 SADP Interface

Note:

The SADP software supports activating the camera in batch. Please refer to the user manual of SADP software for details.

3. Create a password and input the password in the password field, and confirm the password.



STRONG PASSWORD RECOMMENDED– *We highly recommend you create a strong password of your own choosing (using a minimum of 8 characters, including upper case letters, lower case letters, numbers, and special characters) in order to increase the security of your product. And we recommend you reset your password regularly, especially in the high security system, resetting the password monthly or weekly can better protect your product.*

4. Click **Activate** to start activation.

You can check whether the activation is completed on the popup window. If activation failed, please make sure that the password meets the requirement and try again.

3.3 Modifying the IP Address

Purpose:

To view and configure the camera via LAN (Local Area Network), you need to connect the network camera in the same subnet with your PC.

Use the SADP software or client software to search and change the IP address of the device. We take modifying the IP Address via SADP software as an example to introduce the IP address modification.

For IP address modification via client software, refer to the user manual of client software.

Steps:

1. Run the SADP software.
2. Select an active device.

3. Change the device IP address to the same subnet with your computer by either modifying the IP address manually or checking the checkbox of Enable DHCP.

Modify Network Parameters

Enable DHCP

Device Serial No.:

IP Address:

Port:

Subnet Mask:

Gateway:

IPv6 Address:

IPv6 Gateway:

IPv6 Prefix Length:

HTTP Port:

Security Verification

Admin Password:

[Modify](#)

[Forgot Password](#)

Figure 3-5 Modify the IP Address

4. Input the admin password and click **Modify** to activate your IP address modification.

The batch IP address modification is supported by the SADP; please refer to the User Manual of SADP for details.

4 Accessing via Web Browser

System Requirement:

Operating System: Microsoft Windows XP SP1 and above version

CPU: 2.0 GHz or higher

RAM: 1G or higher

Display: 1024×768 resolution or higher

Web Browser: Internet Explorer 8.0 and above version, Apple Safari 5.0.2 and above version, Mozilla Firefox 5.0 and above version and Google Chrome 18 and above version

Steps:

1. Open the web browser.
2. In the browser address bar, input the IP address of the network camera, and press the **Enter** key to enter the login interface.

Note:

The default IP address is 192.168.1.64. You are recommended to change the IP address to the same subnet with your computer.

3. Input the user name and password.

The admin user should configure the device accounts and user/operator permissions properly. Delete the unnecessary accounts and user/operator permissions.

Note:

The device IP address gets locked if the admin user performs 7 failed password attempts (5 attempts for the user/operator).

4. Click **Login**.



Figure 4-1 Login Interface

5. Install the plug-in before viewing the live video and managing the camera. Please follow the installation prompts to install the plug-in.

Note:

You may have to close the web browser to finish the installation of the plug-in.

[Please click here to download and install the plug-in. Close the browser when installing the plug-in.](#)

Figure 1-1 Download Plug-in

6. Reopen the web browser after the installation of the plug-in and repeat steps 2 to 4 to login.

Note:

For detailed instructions of further configuration, please refer to the user manual of network camera.



First Choice for Security Professionals