



WIPC-301W

Manual

Home View Camera

Indoor IP Kamera
Video Cámara PTZ
Camera IP
Caméra IP

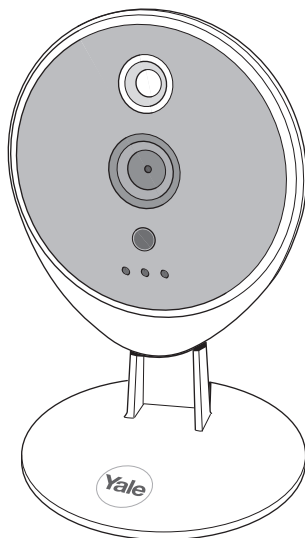

An ASSA ABLOY Group brand

ASSA ABLOY

The smarter way to protect your home.

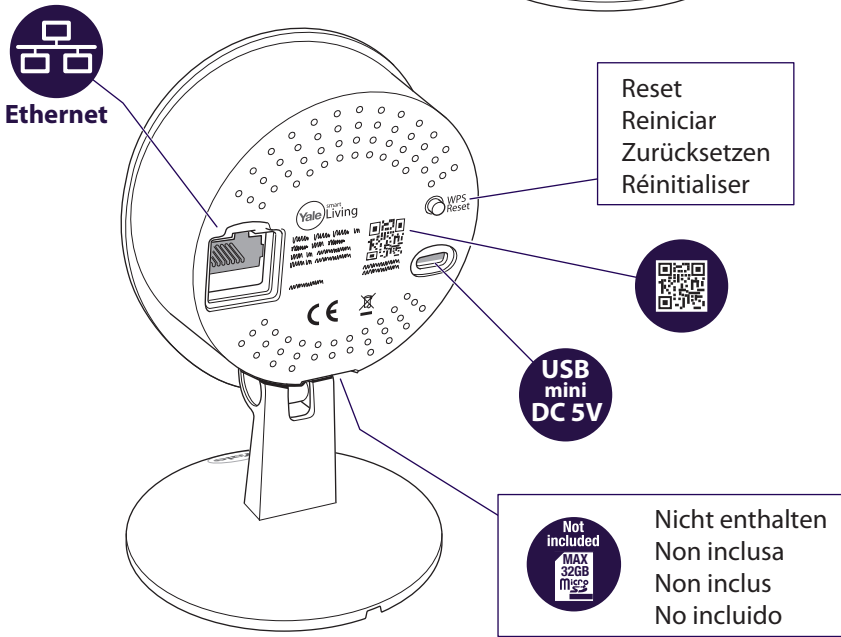

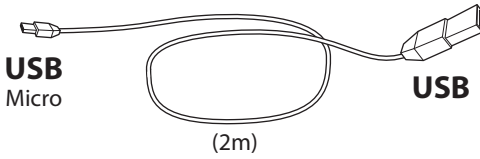
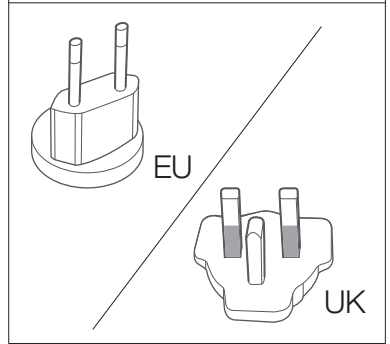
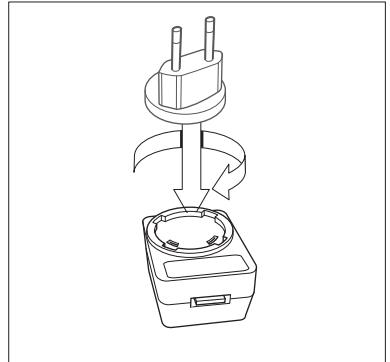
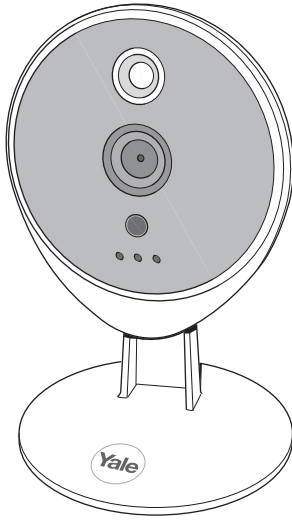

USB
Micro

USB

(2m)

1

Yale Home View 

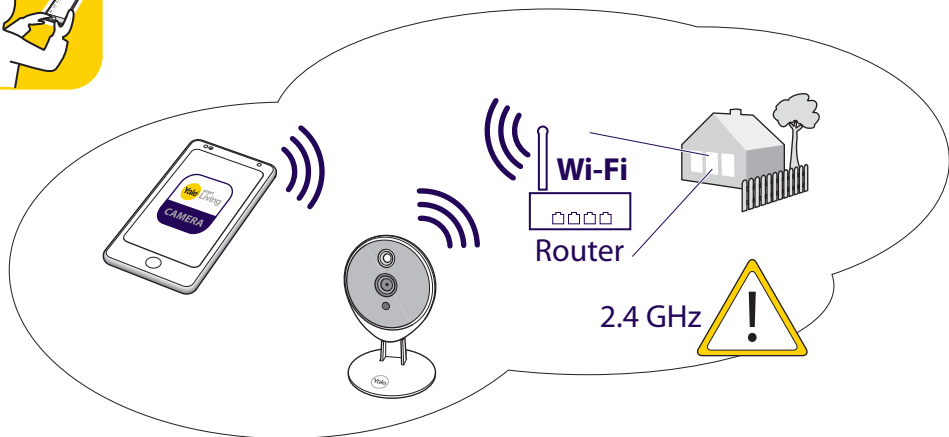

2 Create Account

A screenshot of the 'Yale Living smart' login screen. It features the logo at the top, followed by input fields for 'Email address' and 'Password'. There is a checkbox for 'Remember Password'. At the bottom, there are two yellow buttons: 'Login' and 'New User'. A 'Forgot password' link is at the very bottom.A screenshot of the 'Register' screen. It has a back arrow at the top left. The form includes input fields for 'Email Address', 'Password', 'Confirm Password', and 'Country' (with a dropdown arrow). Below these is a checkbox for 'I have read and agree' next to a 'Terms & Conditions' link. A yellow 'Register' button is at the bottom.

3

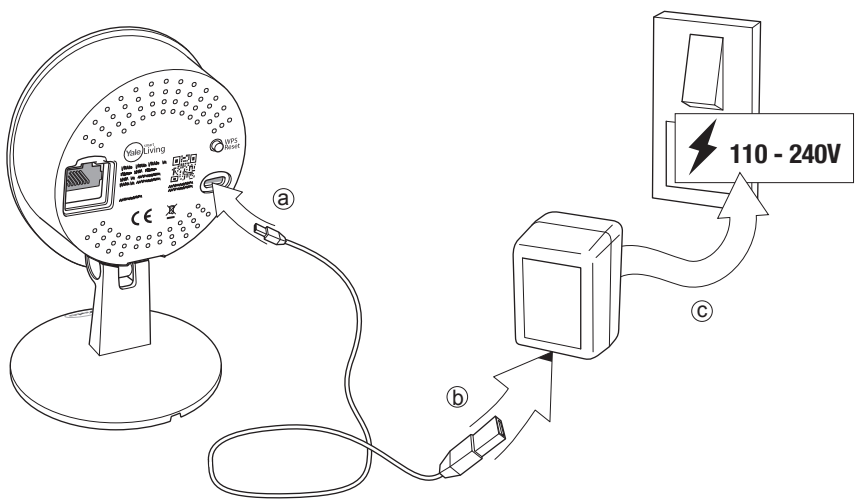

4 App - Setup camera



1

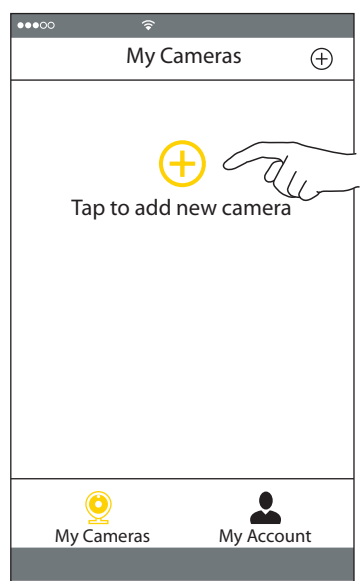

2

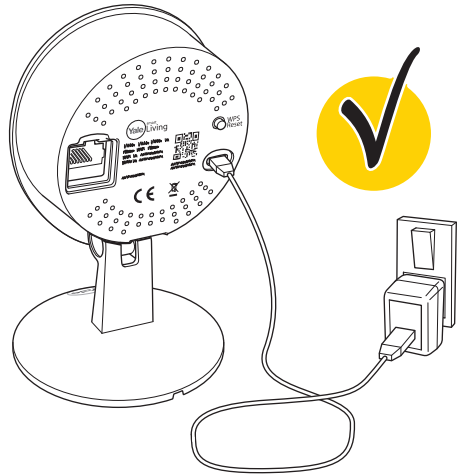
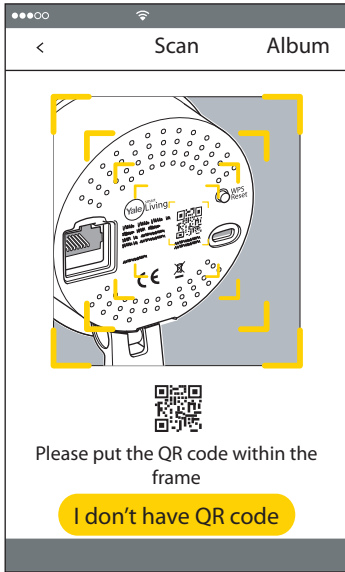

3



4

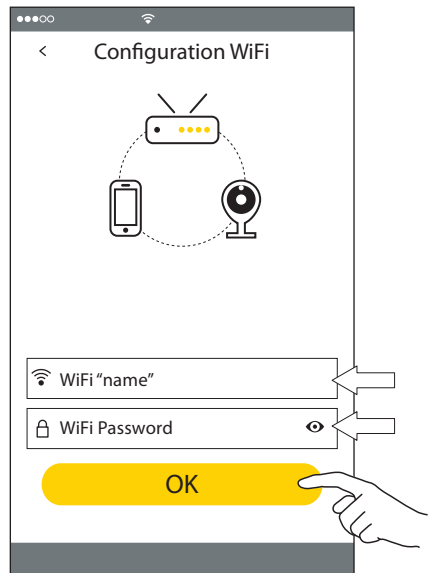

5

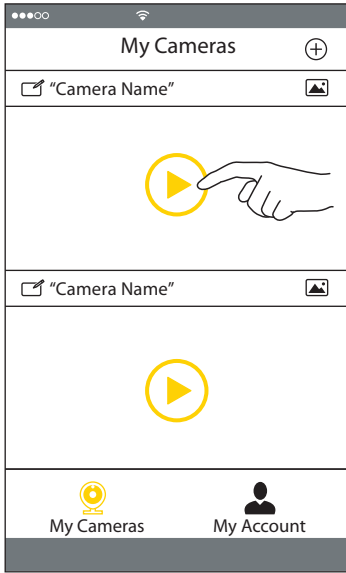

6

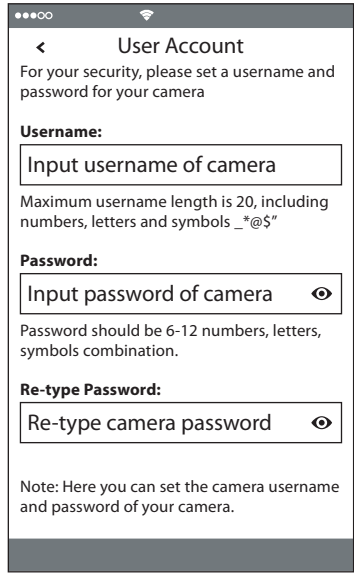

7



i

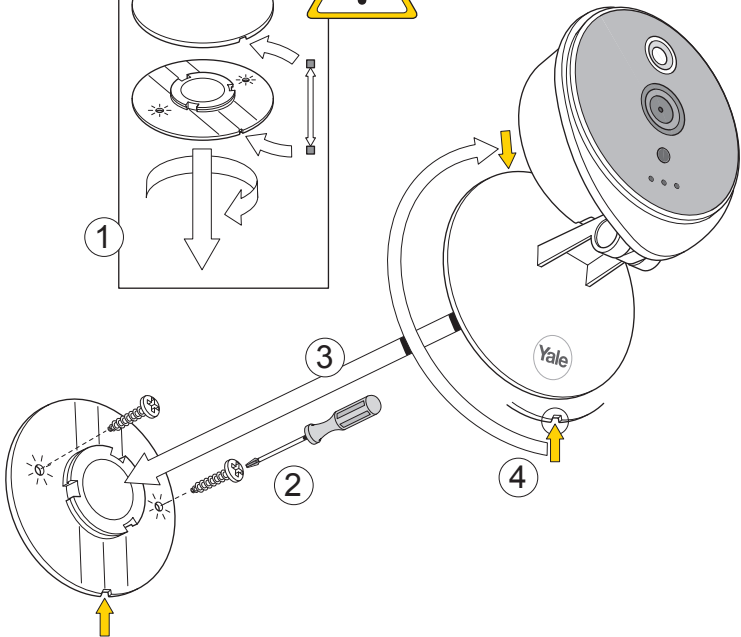
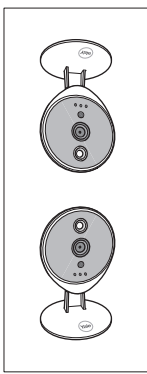
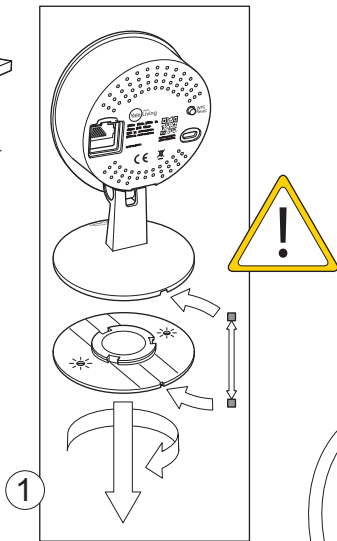
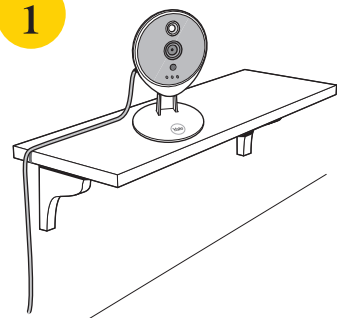

i

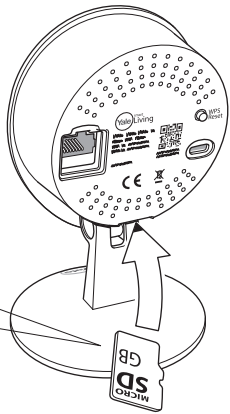
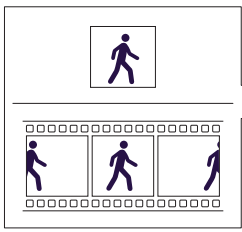



Photo



Video

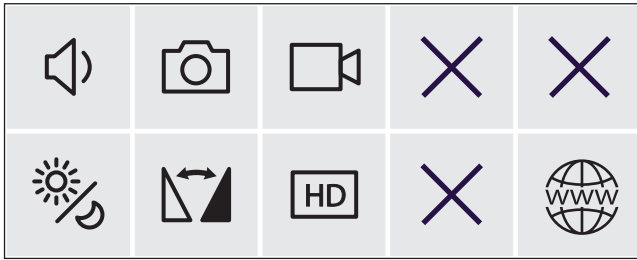
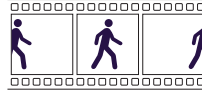

www.yalelock.com/smart-living



On / Off / Auto

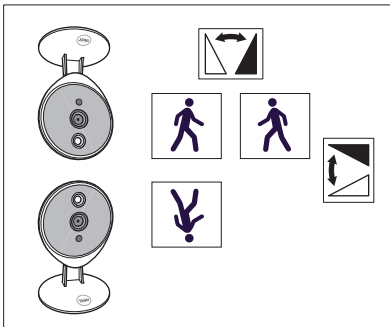

i

GB:

Hereby, ASSA ABLOY Ltd., School Street, Willenhall, West Midlands, England Wv13 3PW declares that the radio equipment type WIPC-301W is in compliance with Directive 2014/53/EU. The full text of the EU declaration of conformity is available at the following internet address: www.yalelock.com/smart-living/doc

FR:

Le soussigné, ASSA ABLOY Ltd., School Street, Willenhall, West Midlands, England Wv13 3PW, déclare que l'équipement radioélectrique du type WIPC-301W est conforme à la directive 2014/53/UE. Le texte complet de la déclaration UE de conformité est disponible à l'adresse internet suivante: www.yalelock.com/smart-living/doc

... Message à destination des professionnels ...

Si vous souhaitez installer WIPC-301W dans votre société, vous devez obligatoirement demander une autorisation à la Commission Nationale de l'Informatique et des Libertés.

ES:

Por la presente, ASSA ABLOY Ltd., School Street, Willenhall, West Midlands, England Wv13 3PW declara que el tipo de equipo radioeléctrico WIPC-301W es conforme con la Directiva 2014/53/UE. El texto completo de la declaración UE de conformidad está disponible en la dirección Internet siguiente: www.yalelock.com/smart-living/doc

DE:

Hiermit erklärt ASSA ABLOY Ltd., School Street, Willenhall, West Midlands, England Wv13 3PW, dass der Funkanlagentyp WIPC-301W der Richtlinie 2014/53/EU entspricht. Der vollständige Text der EU-Konformitätserklärung ist unter der folgenden Internetadresse verfügbar: www.yalelock.com/smart-living/doc

IT:

Il fabbricante, ASSA ABLOY Ltd., School Street, Willenhall, West Midlands, England Wv13 3PW, dichiara che il tipo di apparecchiatura radio WIPC-301W è conforme alla direttiva 2014/53/UE. Il testo completo della dichiarazione di conformità UE è disponibile al seguente indirizzo Internet: 22.5.2014 L 153/104 Gazzetta ufficiale dell'Unione europea IT: www.yalelock.com/smart-living/doc

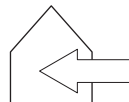
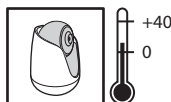
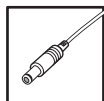

i Support



i

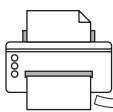

THE YALE BRAND, with its unparalleled global reach and range of products, reassures more people in more countries than any other consumer locking solution.

THE ASSA ABLOY GROUP is the world's leading manufacturer and supplier of locking solutions, dedicated to satisfying end-user needs for security, safety and convenience.

An ASSAABLOY Group brand

ASSA ABLOY

Yale IP301W v04