

HK-SFP-1.25G Series SFP Module

Features and Functions

- Single Power Supply 3.3V
- Small Form Factor Pluggable (SFP) MSA Compatible
- Duplex LC Connector
- Hot Pluggable Capability
- Compliant With ROHS Standard
- Cost effective SFP solution, enables higher port densities and greater bandwidth
- Support 1.25G Ethernet



Specifications

Item	HK-SFP-1.25G-1310-DF-MM
Fiber type	MMF, duplex fiber, 62.5/125um, 50/125um
Connector	LC
Date Rate	1250 Mbps
Connector quantity	2
Distance	0~1km
Wavelength	Tx1310nm/Rx1310nm
TX Power	-9~-3dBm
RX Sens(Max.)	-20dBm
Operating temperature	0~70°C
Storage temperature	-40~85°C
Relative humidity	30~80%
Power supply voltage	DC 3.3V

Typical applications

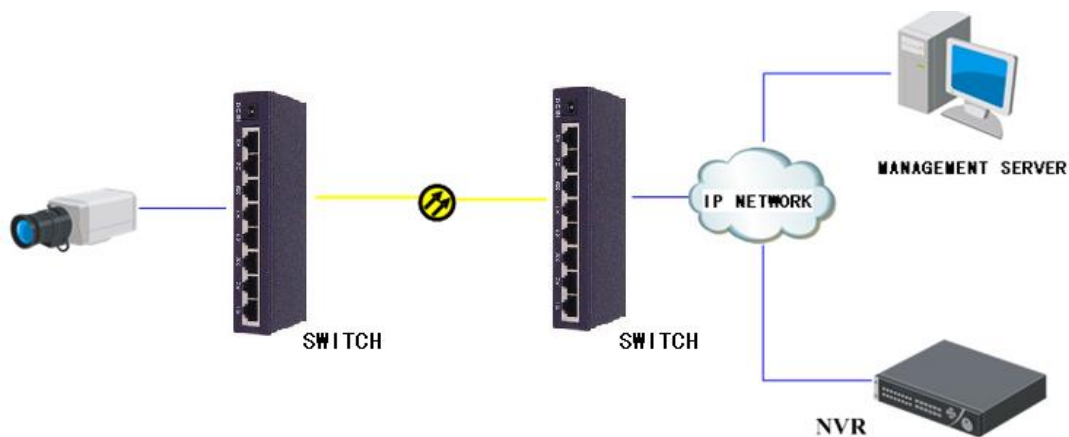

Mechanical (mm)

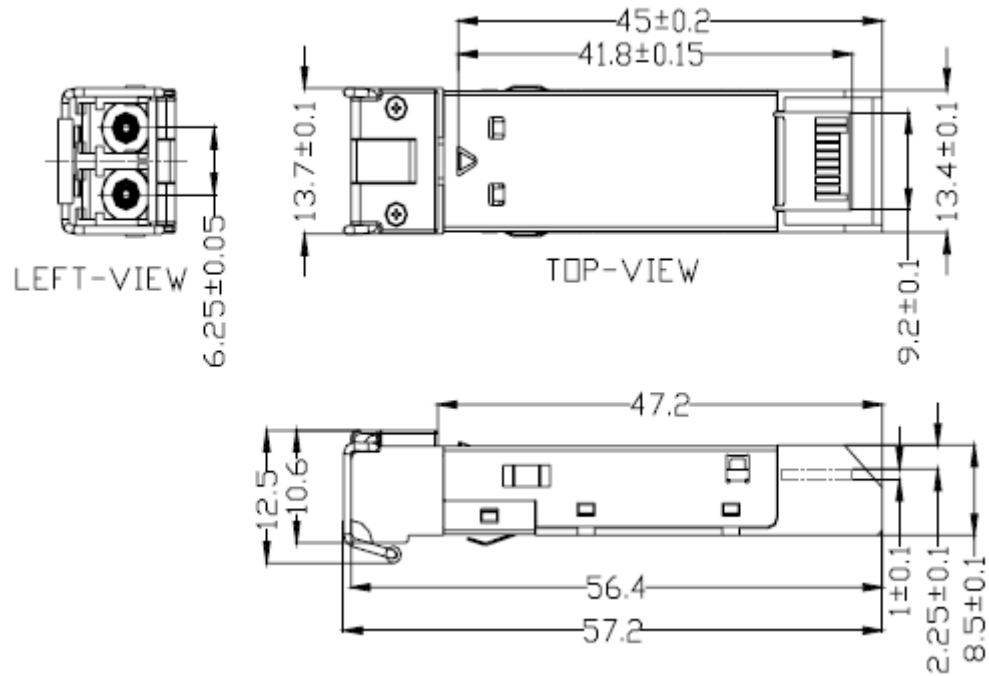

Distributed by



Headquarters

No.555 Qianmo Road, Binjiang District,
Hangzhou 310051, China
T +86-571-8807-5998
overseasbusiness@hikvision.com

Hikvision USA
T +1-909-895-0400
sales.usa@hikvision.com

Hikvision Italy
T +39-0438-6902
info.it@hikvision.com

Hikvision Singapore
T +65-6684-4718
sg@hikvision.com

Hikvision Europe
T +31-23-5542770
saleseuro@hikvision.com

Hikvision France
T +33(0)1-85-330-444
info.fr@hikvision.com

Hikvision Oceania
T +61-2-8599-4233
salesau@hikvision.com

Hikvision Middle East
T +971-4-8816086
salesme@hikvision.com

Hikvision Spain
T +34-91-737-16-55
info.es@hikvision.com

Hikvision Hong Kong
T +852-2151-1761

Hikvision Russia
T +7-495-669-67-99
saleru@hikvision.com

Hikvision Poland
T +48-22-460-01-50
poland@hikvision.com

Hikvision Canada
T +1-909-895-0400
sales.usa@hikvision.com

Hikvision India
T +91-22-28469900
sales@pramahikvision.com

Hikvision UK
T +44-1628-9021-4
support.uk@hikvision.com